

FEATURES

- 10 kΩ and 100 kΩ resistance options
- Resistor tolerance: 8% maximum
- Wiper current: ±6 mA
- Low temperature coefficient: 35 ppm/°C
- Wide bandwidth: 3 MHz
- Fast start-up time < 75 μs
- Linear gain setting mode
- Single- and dual-supply operation
- Independent logic supply: 1.8 V to 5.5 V
- Wide operating temperature: -40°C to +125°C
- 4 mm × 4 mm package option

APPLICATIONS

- Portable electronics level adjustment
- LCD panel brightness and contrast controls
- Programmable filters, delays, and time constants
- Programmable power supplies

FUNCTIONAL BLOCK DIAGRAM

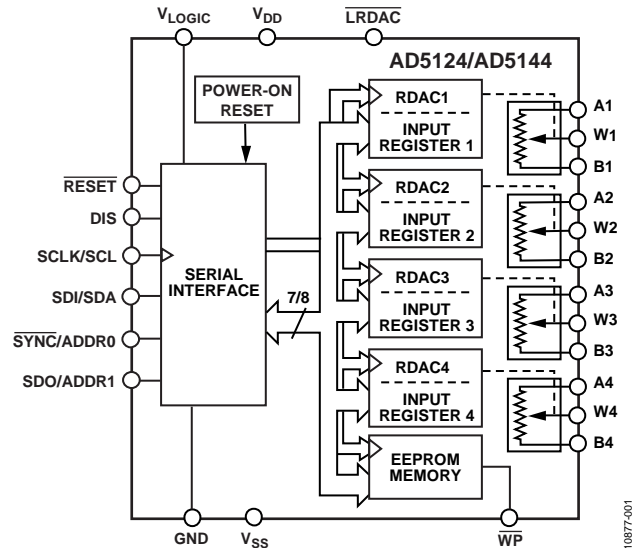

Figure 1. AD5124/AD5144 24-Lead LFCSP

GENERAL DESCRIPTION

The AD5124/AD5144/AD5144A potentiometers provide a nonvolatile solution for 128-/256-position adjustment applications, offering guaranteed low resistor tolerance errors of ±8% and up to ±6 mA current density in the Ax, Bx, and Wx pins.

The low resistor tolerance and low nominal temperature coefficient simplify open-loop applications as well as applications requiring tolerance matching.

The linear gain setting mode allows independent programming of the resistance between the digital potentiometer terminals, through the R_{AW} and R_{WB} string resistors, allowing very accurate resistor matching.

The high bandwidth and low total harmonic distortion (THD) ensure optimal performance for ac signals, making these devices suitable for filter design.

The low wiper resistance of only 40 Ω at the ends of the resistor array allow for pin-to-pin connection.

The wiper values can be set through an SPI-/I²C-compatible digital interface that is also used to read back the wiper register and EEPROM contents.

The AD5124/AD5144/AD5144A are available in a compact, 24-lead, 4 mm × 4 mm LFCSP and a 20-lead TSSOP. The parts are guaranteed to operate over the extended industrial temperature range of -40°C to +125°C.

Table 1. Family Models

| Model | Channel | Position | Interface | Package |
|---------------------|---------|----------|----------------------|-------------|
| AD5123 ¹ | Quad | 128 | I ² C | LFCSP |
| AD5124 | Quad | 128 | SPI/I ² C | LFCSP |
| AD5124 | Quad | 128 | SPI | TSSOP |
| AD5143 ¹ | Quad | 256 | I ² C | LFCSP |
| AD5144 | Quad | 256 | SPI/I ² C | LFCSP |
| AD5144 | Quad | 256 | SPI | TSSOP |
| AD5144A | Quad | 256 | I ² C | TSSOP |
| AD5122 | Dual | 128 | SPI | LFCSP/TSSOP |
| AD5122A | Dual | 128 | I ² C | LFCSP/TSSOP |
| AD5142 | Dual | 256 | SPI | LFCSP/TSSOP |
| AD5142A | Dual | 256 | I ² C | LFCSP/TSSOP |
| AD5121 | Single | 128 | SPI/I ² C | LFCSP |
| AD5141 | Single | 256 | SPI/I ² C | LFCSP |

¹ Two potentiometers and two rheostats.

TABLE OF CONTENTS

| | | | |
|--|----|---|----|
| Features | 1 | RDAC Register and EEPROM..... | 23 |
| Applications..... | 1 | Input Shift Register | 23 |
| Functional Block Diagram | 1 | Serial Data Digital Interface Selection, DIS..... | 23 |
| General Description | 1 | SPI Serial Data Interface..... | 23 |
| Revision History | 2 | I ² C Serial Data Interface | 25 |
| Functional Block Diagrams—TSSOP | 3 | I ² C Address..... | 25 |
| Specifications..... | 4 | Advanced Control Modes | 27 |
| Electrical Characteristics—AD5124 | 4 | EEPROM or RDAC Register Protection | 28 |
| Electrical Characteristics—AD5144 and AD5144A..... | 7 | Load RDAC Input Register (LRDAC)..... | 28 |
| Interface Timing Specifications..... | 10 | RDAC Architecture..... | 31 |
| Shift Register and Timing Diagrams | 11 | Programming the Variable Resistor..... | 31 |
| Absolute Maximum Ratings..... | 13 | Programming the Potentiometer Divider | 32 |
| Thermal Resistance | 13 | Terminal Voltage Operating Range | 32 |
| ESD Caution..... | 13 | Power-Up Sequence | 32 |
| Pin Configurations and Function Descriptions | 14 | Layout and Power Supply Biasing..... | 32 |
| Typical Performance Characteristics | 17 | Outline Dimensions | 33 |
| Test Circuits..... | 22 | Ordering Guide | 34 |
| Theory of Operation | 23 | | |

REVISION HISTORY

7/2019—Rev. B to Rev. C

| | |
|----------------------------------|----|
| Added Endnote 2, Table 14 | 26 |
| Added Endnote 2, Table 20 | 29 |
| Updated Outline Dimensions | 33 |

7/2017—Rev. A to Rev. B

| | |
|---|------------|
| Changed LFCSP_WQ to LFCSP..... | Throughout |
| Changes to Features Section..... | 1 |
| Changes to Logic Supply Current Parameter, Table 2 | 5 |
| Added Note 12 to Data Retention Parameter, Table 2; Renumbered Sequentially..... | 6 |
| Changes to Logic Supply Current Parameter, Table 3 | 8 |
| Added Note 12 to Data Retention Parameter, Table 3; Renumbered Sequentially..... | 9 |

| | |
|--|----|
| Changes to Table 7..... | 13 |
| Changes to Figure 11 and Table 11 | 16 |
| Changes to Figure 20..... | 18 |
| Added Figure 21; Renumbered Sequentially | 18 |
| Changes to Figure 24..... | 19 |
| Change to Linear Gain Setting Mode Section | 27 |
| Change to RDAC Architecture Section..... | 31 |
| Updated Outline Dimensions..... | 33 |

12/2012—Rev. 0 to Rev. A

| | |
|--|----|
| Changes to Table 12 and Table 13 | 25 |
|--|----|

10/2012—Revision 0: Initial Version

FUNCTIONAL BLOCK DIAGRAMS—TSSOP



Figure 2. AD5124/AD5144 20-Lead TSSOP

10877-002



Figure 3. AD5144A 20-Lead TSSOP

10877-003

SPECIFICATIONS

ELECTRICAL CHARACTERISTICS—AD5124

$V_{DD} = 2.3 \text{ V to } 5.5 \text{ V}$, $V_{SS} = 0 \text{ V}$; $V_{DD} = 2.25 \text{ V to } 2.75 \text{ V}$, $V_{SS} = -2.25 \text{ V to } -2.75 \text{ V}$; $V_{LOGIC} = 1.8 \text{ V to } 5.5 \text{ V}$, $-40^\circ\text{C} < T_A < +125^\circ\text{C}$, unless otherwise noted.

Table 2.

| Parameter | Symbol | Test Conditions/Comments | Min | Typ ¹ | Max | Unit |
|---|---|--------------------------------|-------|------------------|-------|-----------------------|
| DC CHARACTERISTICS—RHEOSTAT MODE (ALL RDACS) | | | | | | |
| Resolution | N | | 7 | | | Bits |
| Resistor Integral Nonlinearity ² | R-INL | $R_{AB} = 10 \text{ k}\Omega$ | | | | |
| | | $V_{DD} \geq 2.7 \text{ V}$ | -1 | ± 0.1 | +1 | LSB |
| | | $V_{DD} < 2.7 \text{ V}$ | -2.5 | ± 1 | +2.5 | LSB |
| | | $R_{AB} = 100 \text{ k}\Omega$ | | | | |
| | | $V_{DD} \geq 2.7 \text{ V}$ | -0.5 | ± 0.1 | +0.5 | LSB |
| | | $V_{DD} < 2.7 \text{ V}$ | -1 | ± 0.25 | +1 | LSB |
| Resistor Differential Nonlinearity ² | R-DNL | | -0.5 | ± 0.1 | +0.5 | LSB |
| Nominal Resistor Tolerance | $\Delta R_{AB}/R_{AB}$ | | -8 | ± 1 | +8 | % |
| Resistance Temperature Coefficient ³ | $(\Delta R_{AB}/R_{AB})/\Delta T \times 10^6$ | Code = full scale | | 35 | | ppm/ $^\circ\text{C}$ |
| Wiper Resistance ³ | R_W | Code = zero scale | | | | |
| | | $R_{AB} = 10 \text{ k}\Omega$ | | 55 | 125 | Ω |
| | | $R_{AB} = 100 \text{ k}\Omega$ | | 130 | 400 | Ω |
| Bottom Scale or Top Scale | R_{BS} or R_{TS} | $R_{AB} = 10 \text{ k}\Omega$ | | 40 | 80 | Ω |
| | | $R_{AB} = 100 \text{ k}\Omega$ | | 60 | 230 | Ω |
| Nominal Resistance Match | R_{AB1}/R_{AB2} | Code = 0xFF | -1 | ± 0.2 | +1 | % |
| DC CHARACTERISTICS—POTENTIOMETER DIVIDER MODE (ALL RDACS) | | | | | | |
| Integral Nonlinearity ⁴ | INL | $R_{AB} = 10 \text{ k}\Omega$ | -0.5 | ± 0.1 | +0.5 | LSB |
| | | $R_{AB} = 100 \text{ k}\Omega$ | -0.25 | ± 0.1 | +0.25 | LSB |
| Differential Nonlinearity ⁴ | DNL | | -0.25 | ± 0.1 | +0.25 | LSB |
| | | | | | | |
| Full-Scale Error | V_{WFSE} | $R_{AB} = 10 \text{ k}\Omega$ | -1.5 | -0.1 | | LSB |
| | | $R_{AB} = 100 \text{ k}\Omega$ | -0.5 | ± 0.1 | +0.5 | LSB |
| Zero-Scale Error | V_{WZSE} | $R_{AB} = 10 \text{ k}\Omega$ | | 1 | 1.5 | LSB |
| | | $R_{AB} = 100 \text{ k}\Omega$ | | 0.25 | 0.5 | LSB |
| Voltage Divider Temperature Coefficient ³ | $(\Delta V_W/V_W)/\Delta T \times 10^6$ | Code = half scale | | ± 5 | | ppm/ $^\circ\text{C}$ |

| Parameter | Symbol | Test Conditions/Comments | Min | Typ ¹ | Max | Unit |
|---|-------------------------|---|--|------------------|------------------------|---------------------|
| RESISTOR TERMINALS | | | | | | |
| Maximum Continuous Current | $I_A, I_B,$ and I_W | $R_{AB} = 10\text{ k}\Omega$ $R_{AB} = 100\text{ k}\Omega$ | -6 -1.5 | | +6 +1.5 | mA mA |
| Terminal Voltage Range ⁵ | | | V_{SS} | | V_{DD} | V |
| Capacitance A, Capacitance B ³ | C_A, C_B | $f = 1\text{ MHz}$, measured to GND, code = half scale $R_{AB} = 10\text{ k}\Omega$ $R_{AB} = 100\text{ k}\Omega$ | | 25 12 | | pF pF |
| Capacitance W ³ | C_W | $f = 1\text{ MHz}$, measured to GND, code = half scale $R_{AB} = 10\text{ k}\Omega$ $R_{AB} = 100\text{ k}\Omega$ | | 12 5 | | pF pF |
| Common-Mode Leakage Current ³ | | $V_A = V_W = V_B$ | -500 | ± 15 | +500 | nA |
| DIGITAL INPUTS | | | | | | |
| Input Logic ³ | | | | | | |
| High | V_{INH} | $V_{LOGIC} = 1.8\text{ V to }2.3\text{ V}$ $V_{LOGIC} = 2.3\text{ V to }5.5\text{ V}$ | $0.8 \times V_{LOGIC}$ $0.7 \times V_{LOGIC}$ | | | V V |
| Low | V_{INL} | | | | $0.2 \times V_{LOGIC}$ | V |
| Input Hysteresis ³ | V_{HYST} | | $0.1 \times V_{LOGIC}$ | | | V |
| Input Current ³ | I_{IN} | | | | ± 1 | μA |
| Input Capacitance ³ | C_{IN} | | | 5 | | pF |
| DIGITAL OUTPUTS | | | | | | |
| Output High Voltage ³ | V_{OH} | $R_{PULL-UP} = 2.2\text{ k}\Omega$ to V_{LOGIC} | | V_{LOGIC} | | V |
| Output Low Voltage ³ | V_{OL} | $I_{SINK} = 3\text{ mA}$ $I_{SINK} = 6\text{ mA}, V_{LOGIC} > 2.3\text{ V}$ | | | 0.4 0.6 | V V |
| Three-State Leakage Current | | | -1 | | +1 | μA |
| Three-State Output Capacitance | | | | 2 | | pF |
| POWER SUPPLIES | | | | | | |
| Single-Supply Power Range | | $V_{SS} = \text{GND}$ | 2.3 | | 5.5 | V |
| Dual-Supply Power Range | | | ± 2.25 | | ± 2.75 | V |
| Logic Supply Range | | Single supply, $V_{SS} = \text{GND}$ Dual supply, $V_{SS} < \text{GND}$ | 1.8 2.25 | | V_{DD} V_{DD} | V V |
| Positive Supply Current | I_{DD} | $V_{IH} = V_{LOGIC}$ or $V_{IL} = \text{GND}$ $V_{DD} = 5.5\text{ V}$ $V_{DD} = 2.3\text{ V}$ | | 0.7 400 | 5.5 | μA nA |
| Negative Supply Current | I_{SS} | $V_{IH} = V_{LOGIC}$ or $V_{IL} = \text{GND}$ | -5.5 | -0.7 | | μA |
| EEPROM Store Current ^{3, 6} | $I_{DD_EEPROM_STORE}$ | $V_{IH} = V_{LOGIC}$ or $V_{IL} = \text{GND}$ | | 2 | | mA |
| EEPROM Read Current ^{3, 7} | $I_{DD_EEPROM_READ}$ | $V_{IH} = V_{LOGIC}$ or $V_{IL} = \text{GND}$ | | 320 | | μA |
| Logic Supply Current | I_{LOGIC} | $V_{IH} = V_{LOGIC}$ or $V_{IL} = \text{GND}$ | | 0.05 | 1.4 | μA |
| Power Dissipation ⁸ | P_{DISS} | $V_{IH} = V_{LOGIC}$ or $V_{IL} = \text{GND}$ | | 3.5 | | μW |
| Power Supply Rejection Ratio | PSRR | $\Delta V_{DD}/\Delta V_{SS} = V_{DD} \pm 10\%$, code = full scale | | -66 | -60 | dB |

| Parameter | Symbol | Test Conditions/Comments | Min | Typ ¹ | Max | Unit |
|---|-------------|---|-----|------------------|-----|--|
| DYNAMIC CHARACTERISTICS ⁹ | | | | | | |
| Bandwidth | BW | –3 dB $R_{AB} = 10\text{ k}\Omega$ $R_{AB} = 100\text{ k}\Omega$ | | 3 0.43 | | MHz MHz |
| Total Harmonic Distortion | THD | $V_{DD}/V_{SS} = \pm 2.5\text{ V}$, $V_A = 1\text{ V rms}$, $V_B = 0\text{ V}$, $f = 1\text{ kHz}$ $R_{AB} = 10\text{ k}\Omega$ $R_{AB} = 100\text{ k}\Omega$ | | –80 –90 | | dB dB |
| Resistor Noise Density | e_{N_WB} | Code = half scale, $T_A = 25^\circ\text{C}$, $f = 10\text{ kHz}$ $R_{AB} = 10\text{ k}\Omega$ $R_{AB} = 100\text{ k}\Omega$ | | 7 20 | | nV/ $\sqrt{\text{Hz}}$ nV/ $\sqrt{\text{Hz}}$ |
| V_W Settling Time | t_s | $V_A = 5\text{ V}$, $V_B = 0\text{ V}$, from zero scale to full scale, $\pm 0.5\text{ LSB}$ error band $R_{AB} = 10\text{ k}\Omega$ $R_{AB} = 100\text{ k}\Omega$ | | 2 12 | | μs μs |
| Crosstalk (C_{W1}/C_{W2}) | C_T | $R_{AB} = 10\text{ k}\Omega$ $R_{AB} = 100\text{ k}\Omega$ | | 10 25 | | nV-sec nV-sec |
| Analog Crosstalk Endurance ¹⁰ | C_{TA} | $T_A = 25^\circ\text{C}$ | | –90 1 | | dB Mcycles |
| Data Retention ^{11, 12} | | | 100 | 50 | | kcycles Years |

¹ Typical values represent average readings at 25°C , $V_{DD} = 5\text{ V}$, $V_{SS} = 0\text{ V}$, and $V_{LOGIC} = 5\text{ V}$.

² Resistor integral nonlinearity error (R-INL) is the deviation from an ideal value measured between the maximum resistance and the minimum resistance wiper positions. R-DNL measures the relative step change from ideal between successive tap positions. The maximum wiper current is limited to $(0.7 \times V_{DD})/R_{AB}$.

³ Guaranteed by design and characterization, not subject to production test.

⁴ INL and DNL are measured at V_{WB} with the RDAC configured as a potentiometer divider similar to a voltage output DAC. $V_A = V_{DD}$ and $V_B = 0\text{ V}$. DNL specification limits of $\pm 1\text{ LSB}$ maximum are guaranteed monotonic operating conditions.

⁵ Resistor Terminal A, Resistor Terminal B, and Resistor Terminal W have no limitations on polarity with respect to each other. Dual-supply operation enables ground referenced bipolar signal adjustment.

⁶ Different from operating current; supply current for EEPROM program lasts approximately 30 ms.

⁷ Different from operating current; supply current for EEPROM read lasts approximately 20 μs .

⁸ P_{DISS} is calculated from $(I_{DD} \times V_{DD}) + (I_{LOGIC} \times V_{LOGIC})$.

⁹ All dynamic characteristics use $V_{DD}/V_{SS} = \pm 2.5\text{ V}$, and $V_{LOGIC} = 2.5\text{ V}$.

¹⁰ Endurance is qualified to 100,000 cycles per JEDEC Standard 22, Method A117 and measured at -40°C to $+125^\circ\text{C}$.

¹¹ Retention lifetime equivalent at junction temperature (T_j) = 125°C per JEDEC Standard 22, Method A117. Retention lifetime, based on an activation energy of 1 eV, derates with junction temperature in the Flash/EE memory.

¹² 50 years apply to an endurance of 1000 cycles. An endurance of 100,000 cycles has an equivalent retention lifetime of 5 years.

ELECTRICAL CHARACTERISTICS—AD5144 AND AD5144A

$V_{DD} = 2.3 \text{ V to } 5.5 \text{ V}$, $V_{SS} = 0 \text{ V}$; $V_{DD} = 2.25 \text{ V to } 2.75 \text{ V}$, $V_{SS} = -2.25 \text{ V to } -2.75 \text{ V}$; $V_{LOGIC} = 1.8 \text{ V to } 5.5 \text{ V}$, $-40^\circ\text{C} < T_A < +125^\circ\text{C}$, unless otherwise noted.

Table 3.

| Parameter | Symbol | Test Conditions/Comments | Min | Typ ¹ | Max | Unit |
|---|---|---|------|------------------|------|-----------------------|
| DC CHARACTERISTICS—RHEOSTAT MODE (ALL RDACS) | | | | | | |
| Resolution | N | | 8 | | | Bits |
| Resistor Integral Nonlinearity ² | R-INL | $R_{AB} = 10 \text{ k}\Omega$ $V_{DD} \geq 2.7 \text{ V}$ | -2 | ± 0.2 | +2 | LSB |
| | | $V_{DD} < 2.7 \text{ V}$ $R_{AB} = 100 \text{ k}\Omega$ $V_{DD} \geq 2.7 \text{ V}$ | -5 | ± 1.5 | +5 | LSB |
| Resistor Differential Nonlinearity ² | R-DNL | $V_{DD} < 2.7 \text{ V}$ $R_{AB} = 100 \text{ k}\Omega$ $V_{DD} \geq 2.7 \text{ V}$ | -1 | ± 0.1 | +1 | LSB |
| | | $V_{DD} < 2.7 \text{ V}$ | -2 | ± 0.5 | +2 | LSB |
| Nominal Resistor Tolerance | $\Delta R_{AB}/R_{AB}$ | | -8 | ± 1 | +8 | % |
| Resistance Temperature Coefficient ³ | $(\Delta R_{AB}/R_{AB})/\Delta T \times 10^6$ | Code = full scale | | 35 | | ppm/ $^\circ\text{C}$ |
| Wiper Resistance ³ | R_W | Code = zero scale $R_{AB} = 10 \text{ k}\Omega$ | | 55 | 125 | Ω |
| | | $R_{AB} = 100 \text{ k}\Omega$ | | 130 | 400 | Ω |
| Bottom Scale or Top Scale | R_{BS} or R_{TS} | $R_{AB} = 10 \text{ k}\Omega$ | | 40 | 80 | Ω |
| | | $R_{AB} = 100 \text{ k}\Omega$ | | 60 | 230 | Ω |
| Nominal Resistance Match | R_{AB1}/R_{AB2} | Code = 0xFF | -1 | ± 0.2 | +1 | % |
| DC CHARACTERISTICS—POTENTIOMETER DIVIDER MODE (ALL RDACS) | | | | | | |
| Integral Nonlinearity ⁴ | INL | $R_{AB} = 10 \text{ k}\Omega$ | -1 | ± 0.2 | +1 | LSB |
| | | $R_{AB} = 100 \text{ k}\Omega$ | -0.5 | ± 0.1 | +0.5 | LSB |
| Differential Nonlinearity ⁴ | DNL | | -0.5 | ± 0.2 | +0.5 | LSB |
| | | | | | | |
| Full-Scale Error | V_{WFSE} | $R_{AB} = 10 \text{ k}\Omega$ | -2.5 | -0.1 | | LSB |
| | | $R_{AB} = 100 \text{ k}\Omega$ | -1 | ± 0.2 | +1 | LSB |
| Zero-Scale Error | V_{WZSE} | $R_{AB} = 10 \text{ k}\Omega$ | | 1.2 | 3 | LSB |
| | | $R_{AB} = 100 \text{ k}\Omega$ | | 0.5 | 1 | LSB |
| Voltage Divider Temperature Coefficient ³ | $(\Delta V_W/V_W)/\Delta T \times 10^6$ | Code = half scale | | ± 5 | | ppm/ $^\circ\text{C}$ |

| Parameter | Symbol | Test Conditions/Comments | Min | Typ ¹ | Max | Unit |
|---|------------------------------|--|--|------------------|------------------------|---------------------|
| RESISTOR TERMINALS | | | | | | |
| Maximum Continuous Current | $I_A, I_B, \text{ and } I_W$ | $R_{AB} = 10 \text{ k}\Omega$ $R_{AB} = 100 \text{ k}\Omega$ | -6 -1.5 | | +6 +1.5 | mA mA |
| Terminal Voltage Range ⁵ | | | V_{SS} | | V_{DD} | V |
| Capacitance A, Capacitance B ³ | C_A, C_B | $f = 1 \text{ MHz}$, measured to GND, code = half scale $R_{AB} = 10 \text{ k}\Omega$ $R_{AB} = 100 \text{ k}\Omega$ | | 25 12 | | pF pF |
| Capacitance W ³ | C_W | $f = 1 \text{ MHz}$, measured to GND, code = half scale $R_{AB} = 10 \text{ k}\Omega$ $R_{AB} = 100 \text{ k}\Omega$ | | 12 5 | | pF pF |
| Common-Mode Leakage Current ³ | | $V_A = V_W = V_B$ | -500 | ± 15 | +500 | nA |
| DIGITAL INPUTS | | | | | | |
| Input Logic ³ | | | | | | |
| High | V_{INH} | $V_{LOGIC} = 1.8 \text{ V to } 2.3 \text{ V}$ $V_{LOGIC} = 2.3 \text{ V to } 5.5 \text{ V}$ | $0.8 \times V_{LOGIC}$ $0.7 \times V_{LOGIC}$ | | | V V |
| Low | V_{INL} | | | | $0.2 \times V_{LOGIC}$ | V |
| Input Hysteresis ³ | V_{HYST} | | $0.1 \times V_{LOGIC}$ | | | V |
| Input Current ³ | I_{IN} | | | | ± 1 | μA |
| Input Capacitance ³ | C_{IN} | | | 5 | | pF |
| DIGITAL OUTPUTS | | | | | | |
| Output High Voltage ³ | V_{OH} | $R_{PULL-UP} = 2.2 \text{ k}\Omega \text{ to } V_{LOGIC}$ | | V_{LOGIC} | | V |
| Output Low Voltage ³ | V_{OL} | $I_{SINK} = 3 \text{ mA}$ $I_{SINK} = 6 \text{ mA}, V_{LOGIC} > 2.3 \text{ V}$ | | | 0.4 0.6 | V V |
| Three-State Leakage Current | | | -1 | | +1 | μA |
| Three-State Output Capacitance | | | | 2 | | pF |
| POWER SUPPLIES | | | | | | |
| Single-Supply Power Range | | $V_{SS} = \text{GND}$ | 2.3 | | 5.5 | V |
| Dual-Supply Power Range | | | ± 2.25 | | ± 2.75 | V |
| Logic Supply Range | | Single supply, $V_{SS} = \text{GND}$ Dual supply, $V_{SS} < \text{GND}$ | 1.8 2.25 | | V_{DD} V_{DD} | V V |
| Positive Supply Current | I_{DD} | $V_{IH} = V_{LOGIC}$ or $V_{IL} = \text{GND}$ $V_{DD} = 5.5 \text{ V}$ $V_{DD} = 2.3 \text{ V}$ | | 0.7 400 | 5.5 | μA nA |
| Negative Supply Current | I_{SS} | $V_{IH} = V_{LOGIC}$ or $V_{IL} = \text{GND}$ | -5.5 | -0.7 | | μA |
| EEPROM Store Current ^{3, 6} | $I_{DD_EEPROM_STORE}$ | $V_{IH} = V_{LOGIC}$ or $V_{IL} = \text{GND}$ | | 2 | | mA |
| EEPROM Read Current ^{3, 7} | $I_{DD_EEPROM_READ}$ | $V_{IH} = V_{LOGIC}$ or $V_{IL} = \text{GND}$ | | 320 | | μA |
| Logic Supply Current | I_{LOGIC} | $V_{IH} = V_{LOGIC}$ or $V_{IL} = \text{GND}$ | | 0.05 | 1.4 | μA |
| Power Dissipation ⁸ | P_{DISS} | $V_{IH} = V_{LOGIC}$ or $V_{IL} = \text{GND}$ | | 3.5 | | μW |
| Power Supply Rejection Ratio | PSRR | $\Delta V_{DD}/\Delta V_{SS} = V_{DD} \pm 10\%$, code = full scale | | -66 | -60 | dB |

| Parameter | Symbol | Test Conditions/Comments | Min | Typ ¹ | Max | Unit |
|---|-------------------|--|-----|------------------|-----|------------------|
| DYNAMIC CHARACTERISTICS⁹ | | | | | | |
| Bandwidth | BW | –3 dB R _{AB} = 10 kΩ R _{AB} = 100 kΩ | | 3 0.43 | | MHz MHz |
| Total Harmonic Distortion | THD | V _{DD} /V _{SS} = ±2.5 V, V _A = 1 V rms, V _B = 0 V, f = 1 kHz R _{AB} = 10 kΩ R _{AB} = 100 kΩ | | –80 –90 | | dB dB |
| Resistor Noise Density | e _{N_WB} | Code = half scale, T _A = 25°C, f = 10 kHz R _{AB} = 10 kΩ R _{AB} = 100 kΩ | | 7 20 | | nV/√Hz nV/√Hz |
| V _W Settling Time | t _s | V _A = 5 V, V _B = 0 V, from zero scale to full scale, ±0.5 LSB error band R _{AB} = 10 kΩ R _{AB} = 100 kΩ | | 2 12 | | μs μs |
| Crosstalk (C _{W1} /C _{W2}) | C _T | R _{AB} = 10 kΩ R _{AB} = 100 kΩ | | 10 25 | | nV-sec nV-sec |
| Analog Crosstalk Endurance ¹⁰ | C _{TA} | T _A = 25°C | | –90 1 | | dB Mcycles |
| Data Retention ^{11, 12} | | | 100 | 50 | | kcycles Years |

¹ Typical values represent average readings at 25°C, V_{DD} = 5 V, V_{SS} = 0 V, and V_{LOGIC} = 5 V.

² Resistor integral nonlinearity error (R-INL) is the deviation from an ideal value measured between the maximum resistance and the minimum resistance wiper positions. R-DNL measures the relative step change from ideal between successive tap positions. The maximum wiper current is limited to (0.7 × V_{DD})/R_{AB}.

³ Guaranteed by design and characterization, not subject to production test.

⁴ INL and DNL are measured at V_{WB} with the RDAC configured as a potentiometer divider similar to a voltage output DAC. V_A = V_{DD} and V_B = 0 V. DNL specification limits of ±1 LSB maximum are guaranteed monotonic operating conditions.

⁵ Resistor Terminal A, Resistor Terminal B, and Resistor Terminal W have no limitations on polarity with respect to each other. Dual-supply operation enables ground referenced bipolar signal adjustment.

⁶ Different from operating current; supply current for EEPROM program lasts approximately 30 ms.

⁷ Different from operating current; supply current for EEPROM read lasts approximately 20 μs.

⁸ P_{DISS} is calculated from (I_{DD} × V_{DD}) + (I_{LOGIC} × V_{LOGIC}).

⁹ All dynamic characteristics use V_{DD}/V_{SS} = ±2.5 V, and V_{LOGIC} = 2.5 V.

¹⁰ Endurance is qualified to 100,000 cycles per JEDEC Standard 22, Method A117 and measured at –40°C to +125°C.

¹¹ Retention lifetime equivalent at junction temperature (T_J) = 125°C per JEDEC Standard 22, Method A117. Retention lifetime, based on an activation energy of 1 eV, derates with junction temperature in the Flash/EE memory.

¹² 50 years apply to an endurance of 1000 cycles. An endurance of 100,000 cycles has an equivalent retention lifetime of 5 years.

INTERFACE TIMING SPECIFICATIONS

$V_{\text{LOGIC}} = 1.8 \text{ V}$ to 5.5 V ; all specifications T_{MIN} to T_{MAX} , unless otherwise noted.

Table 4. SPI Interface

| Parameter ¹ | Test Conditions/Comments | Min | Typ | Max | Unit | Description |
|-----------------------------|------------------------------------|-----|-----|-----|------|--|
| t ₁ | $V_{\text{LOGIC}} > 1.8 \text{ V}$ | 20 | | | ns | SCLK cycle time |
| | $V_{\text{LOGIC}} = 1.8 \text{ V}$ | 30 | | | ns | |
| t ₂ | $V_{\text{LOGIC}} > 1.8 \text{ V}$ | 10 | | | ns | SCLK high time |
| | $V_{\text{LOGIC}} = 1.8 \text{ V}$ | 15 | | | ns | |
| t ₃ | $V_{\text{LOGIC}} > 1.8 \text{ V}$ | 10 | | | ns | SCLK low time |
| | $V_{\text{LOGIC}} = 1.8 \text{ V}$ | 15 | | | ns | |
| t ₄ | | 10 | | | ns | $\overline{\text{SYNC}}$ -to-SCLK falling edge setup time |
| t ₅ | | 5 | | | ns | Data setup time |
| t ₆ | | 5 | | | ns | Data hold time |
| t ₇ | | 10 | | | ns | $\overline{\text{SYNC}}$ rising edge to next SCLK fall ignored |
| t ₈ ² | | 20 | | | ns | Minimum $\overline{\text{SYNC}}$ high time |
| t ₉ ³ | | | 50 | | ns | SCLK rising edge to SDO valid |
| t ₁₀ | | | | 500 | ns | $\overline{\text{SYNC}}$ rising edge to SDO pin disable |

¹ All input signals are specified with $t_r = t_f = 1 \text{ ns/V}$ (10% to 90% of V_{DD}) and timed from a voltage level of $(V_{\text{IL}} + V_{\text{IH}})/2$.

² Refer to $t_{\text{EEPROM_PROGRAM}}$ and $t_{\text{EEPROM_READBACK}}$ for memory commands operations (see Table 6).

³ $R_{\text{PULL_UP}} = 2.2 \text{ k}\Omega$ to V_{DD} with a capacitance load of 168 pF.

Table 5. I²C Interface

| Parameter ¹ | Test Conditions/Comments | Min | Typ | Max | Unit | Description |
|-------------------------------|--------------------------|-------------------------|-----|------|------|--|
| f _{SCL} ² | Standard mode | | | 100 | kHz | Serial clock frequency |
| | Fast mode | | | 400 | kHz | |
| t ₁ | Standard mode | 4.0 | | | μs | SCL high time, t _{HIGH} |
| | Fast mode | 0.6 | | | μs | |
| t ₂ | Standard mode | 4.7 | | | μs | SCL low time, t _{LOW} |
| | Fast mode | 1.3 | | | μs | |
| t ₃ | Standard mode | 250 | | | ns | Data setup time, t _{SU; DAT} |
| | Fast mode | 100 | | | ns | |
| t ₄ | Standard mode | 0 | | 3.45 | μs | Data hold time, t _{HD; DAT} |
| | Fast mode | 0 | | 0.9 | μs | |
| t ₅ | Standard mode | 4.7 | | | μs | Setup time for a repeated start condition, t _{SU; STA} |
| | Fast mode | 0.6 | | | μs | |
| t ₆ | Standard mode | 4 | | | μs | Hold time (repeated) for a start condition, t _{HD; STA} |
| | Fast mode | 0.6 | | | μs | |
| t ₇ | Standard mode | 4.7 | | | μs | Bus free time between a stop and a start condition, t _{BUF} |
| | Fast mode | 1.3 | | | μs | |
| t ₈ | Standard mode | 4 | | | μs | Setup time for a stop condition, t _{SU; STO} |
| | Fast mode | 0.6 | | | μs | |
| t ₉ | Standard mode | | | 1000 | ns | Rise time of SDA signal, t _{RDA} |
| | Fast mode | 20 + 0.1 C _L | | 300 | ns | |
| t ₁₀ | Standard mode | | | 300 | ns | Fall time of SDA signal, t _{FDA} |
| | Fast mode | 20 + 0.1 C _L | | 300 | ns | |
| t ₁₁ | Standard mode | | | 1000 | ns | Rise time of SCL signal, t _{RCL} |
| | Fast mode | 20 + 0.1 C _L | | 300 | ns | |
| t _{11A} | Standard mode | | | 1000 | ns | Rise time of SCL signal after a repeated start condition and after an acknowledge bit, t _{RCL1} (not shown in Figure 5) |
| | Fast mode | 20 + 0.1 C _L | | 300 | ns | |

| Parameter ¹ | Test Conditions/Comments | Min | Typ | Max | Unit | Description |
|------------------------------|--------------------------|-------------------------|-----|-----|------|---|
| t ₁₂ | Standard mode | | | 300 | ns | Fall time of SCL signal, t _{FCL} |
| | Fast mode | 20 + 0.1 C _L | | 300 | ns | |
| t _{sp} ³ | Fast mode | 0 | | 50 | ns | Pulse width of suppressed spike |

¹ Maximum bus capacitance is limited to 400 pF.

² The SDA and SCL timing is measured with the input filters enabled. Switching off the input filters improves the transfer rate; however, it has a negative effect on the EMC behavior of the part.

³ Input filtering on the SCL and SDA inputs suppresses noise spikes that are less than 50 ns for fast mode.

Table 6. Control Pins

| Parameter | Min | Typ | Max | Unit | Description |
|--|-----|-----|-----|------|---|
| t ₁ | 1 | | | μs | End command to $\overline{\text{LRDAC}}$ falling edge |
| t ₂ | 50 | | | ns | Minimum $\overline{\text{LRDAC}}$ low time |
| t ₃ | 0.1 | | 10 | μs | $\overline{\text{RESET}}$ low time |
| t _{EPROGRAM_PROGRAM} ¹ | | 15 | 50 | ms | Memory program time (not shown in Figure 8) |
| t _{EPROGRAM_READBACK} | | 7 | 30 | μs | Memory readback time (not shown in Figure 8) |
| t _{POWER_UP} ² | | | 75 | μs | Start-up time (not shown in Figure 8) |
| t _{RESET} | | 30 | | μs | Reset EEPROM restore time (not shown in Figure 8) |

¹ EEPROM program time depends on the temperature and EEPROM write cycles. Higher timing is expected at lower temperatures and higher write cycles.

² Maximum time after V_{DD} – V_{SS} is equal to 2.3 V.

SHIFT REGISTER AND TIMING DIAGRAMS



Figure 4. Input Shift Register Contents



Figure 5. I²C Serial Interface Timing Diagram (Typical Write Sequence)



Figure 6. SPI Serial Interface Timing Diagram, CPOL = 0, CPHA = 1

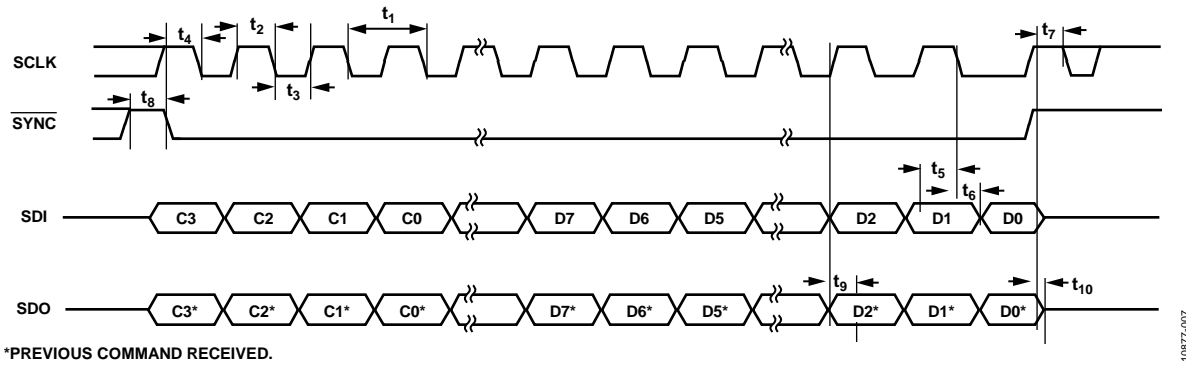

Figure 7. SPI Serial Interface Timing Diagram, CPOL = 1, CPHA = 0

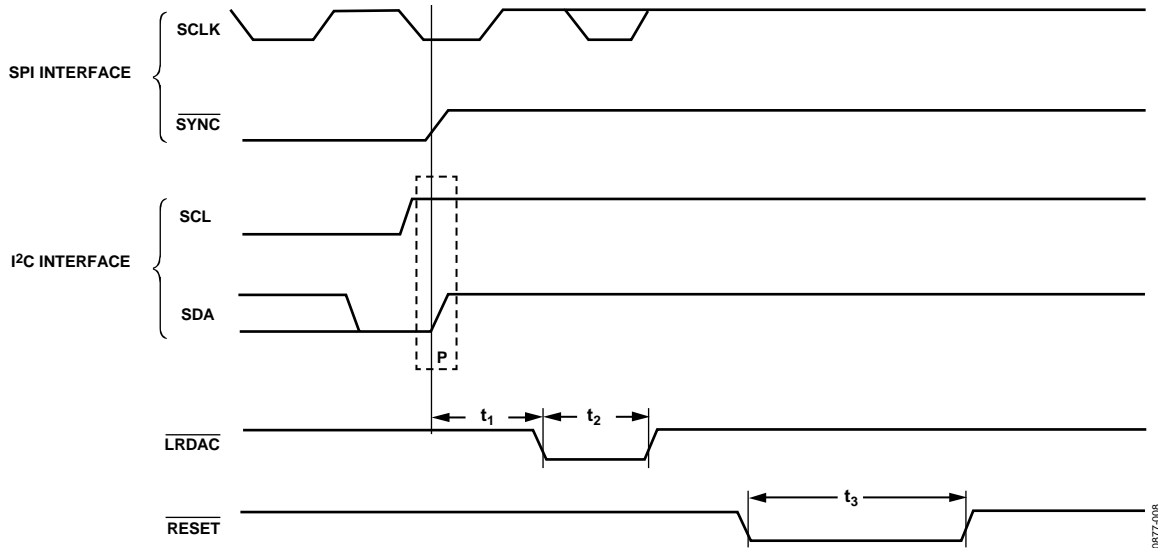

Figure 8. Control Pins Timing Diagram

ABSOLUTE MAXIMUM RATINGS

$T_A = 25^\circ\text{C}$, unless otherwise noted.

Table 7.

| Parameter | Rating |
|---|--|
| V_{DD} to GND | $-0.3\text{ V to }+7.0\text{ V}$ |
| V_{SS} to GND | $+0.3\text{ V to }-7.0\text{ V}$ |
| V_{DD} to V_{SS} | 7 V |
| V_{LOGIC} to GND | $-0.3\text{ V to }V_{DD} + 0.3\text{ V}$ or $+7.0\text{ V}$ (whichever is less) |
| V_A, V_W, V_B to GND | $V_{SS} - 0.3\text{ V}, V_{DD} + 0.3\text{ V}$ |
| I_A, I_W, I_B | |
| Pulsed ¹ | |
| Frequency > 10 kHz | |
| $R_{AW} = 10\text{ k}\Omega$ | $\pm 6\text{ mA/d}^2$ |
| $R_{AW} = 100\text{ k}\Omega$ | $\pm 1.5\text{ mA/d}^2$ |
| Frequency $\leq 10\text{ kHz}$ | |
| $R_{AW} = 10\text{ k}\Omega$ | $\pm 6\text{ mA}/\sqrt{\text{d}^2}$ |
| $R_{AW} = 100\text{ k}\Omega$ | $\pm 1.5\text{ mA}/\sqrt{\text{d}^2}$ |
| Digital Inputs | $-0.3\text{ V to }V_{\text{LOGIC}} + 0.3\text{ V}$ or $+7\text{ V}$ (whichever is less) |
| Operating Temperature Range, T_A ³ | $-40^\circ\text{C to }+125^\circ\text{C}$ |
| Maximum Junction Temperature, T_J Maximum | 150°C |
| Storage Temperature Range | $-65^\circ\text{C to }+150^\circ\text{C}$ |
| Reflow Soldering | |
| Peak Temperature | 260°C |
| Time at Peak Temperature | 20 sec to 40 sec |
| Package Power Dissipation | $(T_J \text{ max} - T_A)/\theta_{JA}$ |
| FICDM | 1.5 kV |

¹ Maximum terminal current is bounded by the maximum current handling of the switches, maximum power dissipation of the package, and maximum applied voltage across any two of the A, B, and W terminals at a given resistance.

² d = pulse duty factor.

³ Includes programming of EEPROM memory.

Stresses at or above those listed under Absolute Maximum Ratings may cause permanent damage to the product. This is a stress rating only; functional operation of the product at these or any other conditions above those indicated in the operational section of this specification is not implied. Operation beyond the maximum operating conditions for extended periods may affect product reliability.

THERMAL RESISTANCE

θ_{JA} is defined by the JEDEC JESD51 standard, and the value is dependent on the test board and test environment.

Table 8. Thermal Resistance

| Package Type | θ_{JA} | θ_{JC} | Unit |
|---------------|------------------|---------------|--------------------|
| 24-Lead LFCSP | 35 ¹ | 3 | $^\circ\text{C/W}$ |
| 20-Lead TSSOP | 143 ¹ | 45 | $^\circ\text{C/W}$ |

¹ JEDEC 2S2P test board, still air (0 m/sec airflow).

ESD CAUTION



ESD (electrostatic discharge) sensitive device. Charged devices and circuit boards can discharge without detection. Although this product features patented or proprietary protection circuitry, damage may occur on devices subjected to high energy ESD. Therefore, proper ESD precautions should be taken to avoid performance degradation or loss of functionality.

PIN CONFIGURATIONS AND FUNCTION DESCRIPTIONS



Figure 9. 20-Lead TSSOP, SPI Interface Pin Configuration (AD5124/AD5144)

Table 9. 20-Lead TSSOP, SPI Interface Pin Function Descriptions (AD5124/AD5144)

| Pin No. | Mnemonic | Description |
|---------|--------------------|---|
| 1 | SYNC | Synchronization Data Input, Active Low. When SYNC returns high, data is loaded into the input shift register. |
| 2 | GND | Ground Pin, Logic Ground Reference. |
| 3 | A1 | Terminal A of RDAC1. $V_{SS} \leq V_A \leq V_{DD}$. |
| 4 | W1 | Wiper Terminal of RDAC1. $V_{SS} \leq V_W \leq V_{DD}$. |
| 5 | B1 | Terminal B of RDAC1. $V_{SS} \leq V_B \leq V_{DD}$. |
| 6 | A3 | Terminal A of RDAC3. $V_{SS} \leq V_A \leq V_{DD}$. |
| 7 | W3 | Wiper Terminal of RDAC3. $V_{SS} \leq V_W \leq V_{DD}$. |
| 8 | B3 | Terminal B of RDAC3. $V_{SS} \leq V_B \leq V_{DD}$. |
| 9 | V _{SS} | Negative Power Supply. Decouple this pin with 0.1 μ F ceramic capacitors and 10 μ F capacitors. |
| 10 | A2 | Terminal A of RDAC2. $V_{SS} \leq V_A \leq V_{DD}$. |
| 11 | W2 | Wiper Terminal of RDAC2. $V_{SS} \leq V_W \leq V_{DD}$. |
| 12 | B2 | Terminal B of RDAC2. $V_{SS} \leq V_B \leq V_{DD}$. |
| 13 | A4 | Terminal A of RDAC4. $V_{SS} \leq V_A \leq V_{DD}$. |
| 14 | W4 | Wiper Terminal of RDAC4. $V_{SS} \leq V_W \leq V_{DD}$. |
| 15 | B4 | Terminal B of RDAC4. $V_{SS} \leq V_B \leq V_{DD}$. |
| 16 | V _{DD} | Positive Power Supply. Decouple this pin with 0.1 μ F ceramic capacitors and 10 μ F capacitors. |
| 17 | V _{LOGIC} | Logic Power Supply; 1.8 V to V _{DD} . Decouple this pin with 0.1 μ F ceramic capacitors and 10 μ F capacitors. |
| 18 | SCLK | Serial Clock Line. Data is clocked in at the logic low transition. |
| 19 | SDI | Serial Data Input. |
| 20 | SDO | Serial Data Output. This is an open-drain output pin, and it needs an external pull-up resistor. |



Figure 10. 20-Lead TSSOP, I²C Interface Pin Configuration (AD5144A)

Table 10. 20-Lead TSSOP, I²C Interface Pin Function Descriptions (AD5144A)

| Pin No. | Mnemonic | Description |
|---------|--------------------|---|
| 1 | RESET | Hardware Reset Pin. Refresh the RDAC registers from EEPROM. RESET is activated at the logic low. If this pin is not used, tie RESET to V _{LOGIC} . |
| 2 | GND | Ground Pin, Logic Ground Reference. |
| 3 | A1 | Terminal A of RDAC1. $V_{SS} \leq V_A \leq V_{DD}$. |
| 4 | W1 | Wiper Terminal of RDAC1. $V_{SS} \leq V_W \leq V_{DD}$. |
| 5 | B1 | Terminal B of RDAC1. $V_{SS} \leq V_B \leq V_{DD}$. |
| 6 | A3 | Terminal A of RDAC3. $V_{SS} \leq V_A \leq V_{DD}$. |
| 7 | W3 | Wiper Terminal of RDAC3. $V_{SS} \leq V_W \leq V_{DD}$. |
| 8 | B3 | Terminal B of RDAC3. $V_{SS} \leq V_B \leq V_{DD}$. |
| 9 | V _{SS} | Negative Power Supply. Decouple this pin with 0.1 μF ceramic capacitors and 10 μF capacitors. |
| 10 | A2 | Terminal A of RDAC2. $V_{SS} \leq V_A \leq V_{DD}$. |
| 11 | W2 | Wiper Terminal of RDAC2. $V_{SS} \leq V_W \leq V_{DD}$. |
| 12 | B2 | Terminal B of RDAC2. $V_{SS} \leq V_B \leq V_{DD}$. |
| 13 | A4 | Terminal A of RDAC4. $V_{SS} \leq V_A \leq V_{DD}$. |
| 14 | W4 | Wiper Terminal of RDAC4. $V_{SS} \leq V_W \leq V_{DD}$. |
| 15 | B4 | Terminal B of RDAC4. $V_{SS} \leq V_B \leq V_{DD}$. |
| 16 | V _{DD} | Positive Power Supply. Decouple this pin with 0.1 μF ceramic capacitors and 10 μF capacitors. |
| 17 | V _{LOGIC} | Logic Power Supply; 1.8 V to V _{DD} . Decouple this pin with 0.1 μF ceramic capacitors and 10 μF capacitors. |
| 18 | SCL | Serial Clock Line. Data is clocked in at the logic low transition. |
| 19 | SDA | Serial Data Input/Output. |
| 20 | ADDR | Programmable Address for Multiple Package Decoding. |



NOTES
 1. EXPOSED PAD. CONNECT THE EXPOSED PAD TO THE POTENTIAL OF THE V_{SS} PIN, OR, ALTERNATIVELY, LEAVE IT ELECTRICALLY UNCONNECTED. IT IS RECOMMENDED THAT THE PAD BE THERMALLY CONNECTED TO A COPPER PLANE FOR ENHANCED THERMAL PERFORMANCE.

Figure 11. 24-Lead LFCSP Pin Configuration (AD5124/AD5144)

Table 11. 24-Lead LFCSP Pin Function Descriptions (AD5124/AD5144)

| Pin No. | Mnemonic | Description |
|---------|--------------------------|---|
| 1 | GND | Ground Pin, Logic Ground Reference. |
| 2 | A1 | Terminal A of RDAC1. $V_{SS} \leq V_A \leq V_{DD}$. |
| 3 | W1 | Wiper Terminal of RDAC1. $V_{SS} \leq V_W \leq V_{DD}$. |
| 4 | B1 | Terminal B of RDAC1. $V_{SS} \leq V_B \leq V_{DD}$. |
| 5 | A3 | Terminal A of RDAC3. $V_{SS} \leq V_A \leq V_{DD}$. |
| 6 | W3 | Wiper Terminal of RDAC3. $V_{SS} \leq V_W \leq V_{DD}$. |
| 7 | B3 | Terminal B of RDAC3. $V_{SS} \leq V_B \leq V_{DD}$. |
| 8 | V_{SS} | Negative Power Supply. Decouple this pin with 0.1 μ F ceramic capacitors and 10 μ F capacitors. |
| 9 | A2 | Terminal A of RDAC2. $V_{SS} \leq V_A \leq V_{DD}$. |
| 10 | W2 | Wiper Terminal of RDAC2. $V_{SS} \leq V_W \leq V_{DD}$. |
| 11 | B2 | Terminal B of RDAC2. $V_{SS} \leq V_B \leq V_{DD}$. |
| 12 | A4 | Terminal A of RDAC4. $V_{SS} \leq V_A \leq V_{DD}$. |
| 13 | W4 | Wiper Terminal of RDAC4. $V_{SS} \leq V_W \leq V_{DD}$. |
| 14 | B4 | Terminal B of RDAC4. $V_{SS} \leq V_B \leq V_{DD}$. |
| 15 | V_{DD} | Positive Power Supply. Decouple this pin with 0.1 μ F ceramic capacitors and 10 μ F capacitors. |
| 16 | V_{LOGIC} | Logic Power Supply; 1.8 V to V_{DD} . Decouple this pin with 0.1 μ F ceramic capacitors and 10 μ F capacitors. |
| 17 | SCL/SCLK | I ² C Serial Clock Line (SCL). Data is clocked in at the logic low transition. SPI Serial Clock Line (SCLK). Data is clocked in at the logic low transition. |
| 18 | DIS | Digital Interface Select (SPI/I ² C Select). SPI when DIS = 0 (GND), and I ² C when DIS = 1 (V_{LOGIC}). This pin cannot be left floating. |
| 19 | SDA/SDI | Serial Data Input/Output (SDA), When DIS = 1. Serial Data Input (SDI), When DIS = 0. |
| 20 | \overline{WP} | Optional Write Protect. This pin prevents any changes to the present RDAC and EEPROM content, except when reloading the content of the EEPROM into the RDAC register. \overline{WP} is activated at logic low. If this pin is not used, tie \overline{WP} to V_{LOGIC} . |
| 21 | ADDR1/SDO | Programmable Address (ADDR1) for Multiple Package Decoding, When DIS = 1. Serial Data Output (SDO). Open-drain output, needs an external pull-up resistor, when DIS = 0. |
| 22 | ADDR0/ \overline{SYNC} | Programmable Address (ADDR0) for Multiple Package Decoding, When DIS = 1. Synchronization Data Input, When DIS = 0. This pin is active low. When \overline{SYNC} returns high, data is loaded into the input shift register. |
| 23 | \overline{LRDAC} | Load RDAC. Transfers the contents of the input registers to their respective RDAC registers when their associated input registers were previously loaded using Command 2 (see Table 20). This allows simultaneous update of all RDAC registers. \overline{LRDAC} is activated at the high-to-low transition. If not used, tie \overline{LRDAC} to V_{LOGIC} . |
| 24 | \overline{RESET} | Hardware Reset Pin. Refresh the RDAC registers from EEPROM. \overline{RESET} is activated at the logic low. If not used, tie \overline{RESET} to V_{LOGIC} . |
| | EPAD | Exposed Pad. Connect the exposed pad to the potential of the V_{SS} pin, or, alternatively, leave it electrically unconnected. It is recommended that the pad be thermally connected to a copper plane for enhanced thermal performance. |

TYPICAL PERFORMANCE CHARACTERISTICS



Figure 12. R-INL vs. Code (AD5144/AD5144A)

10877-012

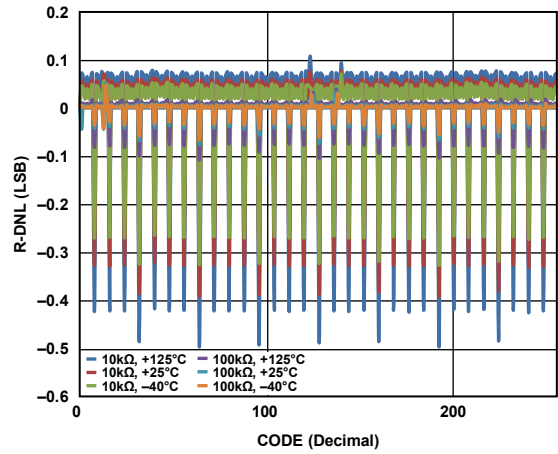

Figure 15. R-DNL vs. Code (AD5144/AD5144A)

10877-015



Figure 13. R-INL vs. Code (AD5124)

10877-013

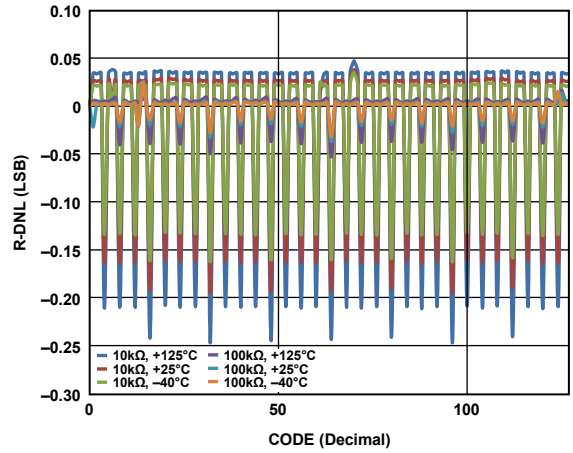

Figure 16. R-DNL vs. Code (AD5124)

10877-016



Figure 14. INL vs. Code (AD5144/AD5144A)

10877-014

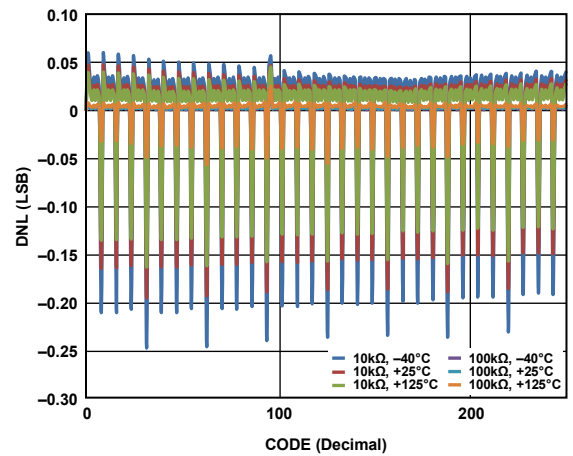

Figure 17. DNL vs. Code (AD5144/AD5144A)

10877-017

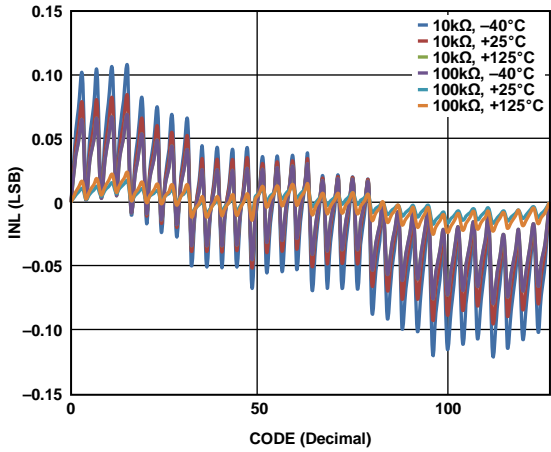

Figure 18. INL vs. Code (AD5124)



Figure 21. I_{LOGIC} vs. Temperature

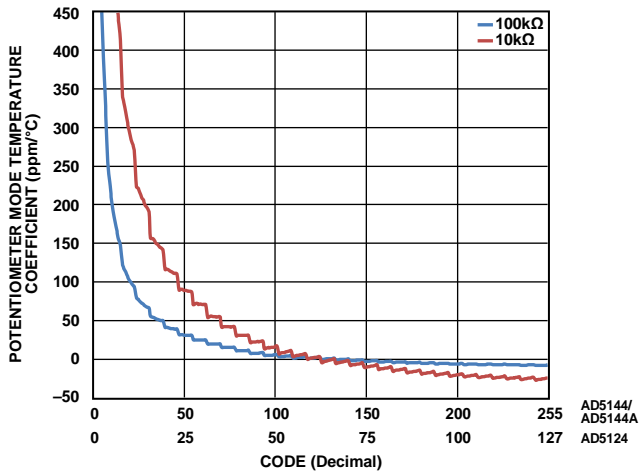

Figure 19. Potentiometer Mode Temperature Coefficient $((\Delta V_w/V_w)/\Delta T \times 10^6)$ vs. Code

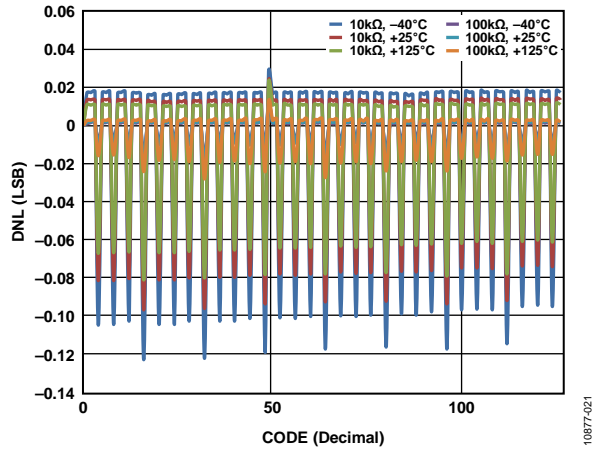

Figure 22. DNL vs. Code (AD5124)

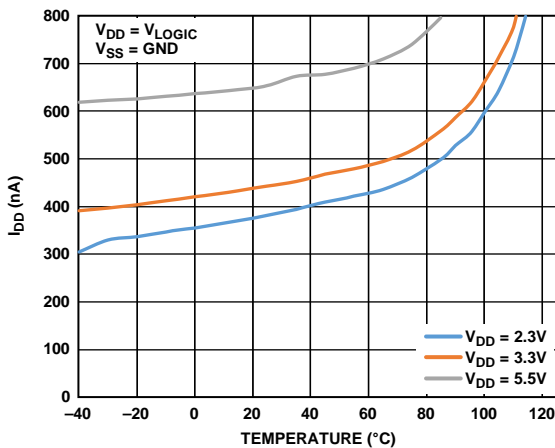

Figure 20. Supply Current vs. Temperature

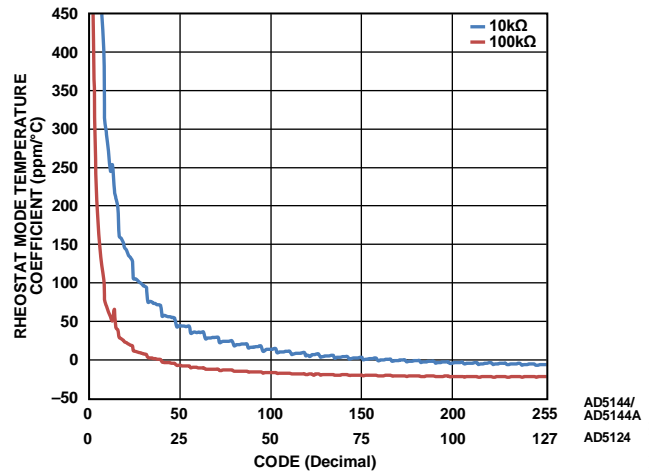

Figure 23. Rheostat Mode Temperature Coefficient $((\Delta R_{WB}/R_{WB})/\Delta T \times 10^6)$ vs. Code



Figure 24. I_{LOGIC} Current vs. Digital Input Voltage



Figure 27. Normalized Phase Flatness vs. Frequency, $R_{AB} = 10\text{ k}\Omega$



Figure 25. 10 kΩ Gain vs. Frequency vs. Code



Figure 28. 100 kΩ Gain vs. Frequency vs. Code



Figure 26. Total Harmonic Distortion Plus Noise (THD + N) vs. Frequency



Figure 29. Total Harmonic Distortion Plus Noise (THD + N) vs. Amplitude



Figure 30. Normalized Phase Flatness vs. Frequency, $R_{AB} = 100\text{ k}\Omega$



Figure 33. Maximum Transition Glitch



Figure 31. Incremental Wiper On Resistance vs. Positive Power Supply (V_{DD})



Figure 34. Resistor Lifetime Drift



Figure 32. Maximum Bandwidth vs. Code vs. Net Capacitance



Figure 35. Power Supply Rejection Ratio (PSRR) vs. Frequency



Figure 36. Digital Feedthrough



Figure 38. Theoretical Maximum Current vs. Code

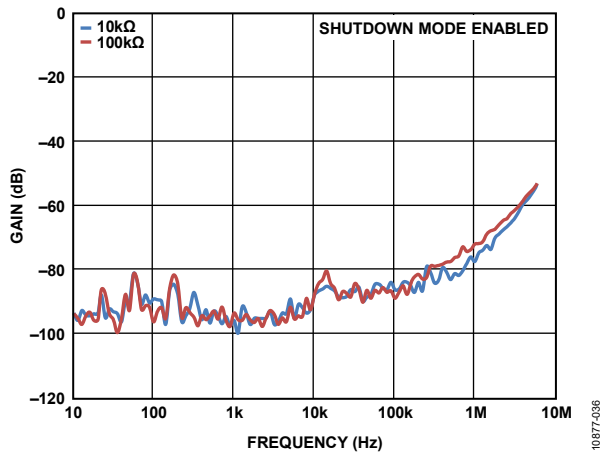

Figure 37. Shutdown Isolation vs. Frequency

TEST CIRCUITS

Figure 39 to Figure 43 define the test conditions used in the Specifications section.



Figure 39. Resistor Integral Nonlinearity Error (Rheostat Operation; R-INL, R-DNL)



Figure 42. Power Supply Sensitivity and Power Supply Rejection Ratio (PSS and PSRR)



Figure 40. Potentiometer Divider Nonlinearity Error (INL, DNL)



Figure 43. Incremental On Resistance



Figure 41. Wiper Resistance

THEORY OF OPERATION

The AD5124/AD5144/AD5144A digital programmable potentiometers are designed to operate as true variable resistors for analog signals within the terminal voltage range of $V_{SS} < V_{TERM} < V_{DD}$. The resistor wiper position is determined by the RDAC register contents. The RDAC register acts as a scratchpad register that allows unlimited changes of resistance settings. A secondary register (the input register) can be used to preload the RDAC register data.

The RDAC register can be programmed with any position setting using the I²C or SPI interface (depending on the model). When a desirable wiper position is found, this value can be stored in the EEPROM memory. Thereafter, the wiper position is always restored to that position for subsequent power-ups. The storing of the EEPROM data takes approximately 15 ms; during this time, the device is locked and does not acknowledge any new command, preventing any changes from taking place.

RDAC REGISTER AND EEPROM

The RDAC register directly controls the position of the digital potentiometer wiper. For example, when the RDAC register is loaded with 0x80 (AD5144/AD5144A, 256 taps), the wiper is connected to half scale of the variable resistor. The RDAC register is a standard logic register; there is no restriction on the number of changes allowed.

It is possible to both write to and read from the RDAC register using the digital interface (see Table 14).

The contents of the RDAC register can be stored to the EEPROM using Command 9 (see Table 14). Thereafter, the RDAC register always sets at that position for any future on-off-on power supply sequence. It is possible to read back data saved into the EEPROM with Command 3 (see Table 14).

Alternatively, the EEPROM can be written to independently using Command 11 (see Table 20).

INPUT SHIFT REGISTER

For the AD5124/AD5144/AD5144A, the input shift register is 16 bits wide, as shown in Figure 4. The 16-bit word consists of four control bits, followed by four address bits and by eight data bits.

If the AD5124 RDAC or EEPROM registers are read from or written to, the lowest data bit (Bit 0) is ignored.

Data is loaded MSB first (Bit 15). The four control bits determine the function of the software command, as listed in Table 14 and Table 20.

SERIAL DATA DIGITAL INTERFACE SELECTION, DIS

The AD5124/AD5144 LFSCP provides the flexibility of a selectable interface. When the digital interface select (DIS) pin is tied low, the SPI mode is engaged. When the DIS pin is tied high, the I²C mode is engaged.

SPI SERIAL DATA INTERFACE

The AD5124/AD5144 contain a 4-wire, SPI-compatible digital interface (SDI, SYNC, SDO, and SCLK). The write sequence begins by bringing the SYNC line low. The SYNC pin must be held low until the complete data-word is loaded from the SDI pin. Data is loaded in at the SCLK falling edge transition, as shown in Figure 6. When SYNC returns high, the serial data-word is decoded according to the instructions in Table 20.

To minimize power consumption in the digital input buffers when the part is enabled, operate all serial interface pins close to the V_{LOGIC} supply rails.

SYNC Interruption

In a standalone write sequence for the AD5124/AD5144, the SYNC line is kept low for 16 falling edges of SCLK, and the instruction is decoded when SYNC is pulled high. However, if the SYNC line is kept low for less than 16 falling edges of SCLK, the input shift register content is ignored, and the write sequence is considered invalid.

SDO Pin

The serial data output pin (SDO) serves two purposes: to read back the contents of the control, EEPROM, RDAC, and input registers using Command 3 (see Table 14 and Table 20), and to connect the AD5124/AD5144 in daisy-chain mode.

The SDO pin contains an internal open-drain output that needs an external pull-up resistor. The SDO pin is enabled when SYNC is pulled low, and the data is clocked out of SDO on the rising edge of SCLK, as shown in Figure 6 and Figure 7.

Daisy-Chain Connection

Daisy chaining minimizes the number of port pins required from the controlling IC. As shown in Figure 44, the SDO pin of one package must be tied to the SDI pin of the next package. The clock period may need to be increased because of the propagation delay of the line between subsequent devices. When two AD5124/AD5144 devices are daisy chained, 32 bits of data are required. The first 16 bits are assigned to U2, and the second 16 bits are assigned to U1, as shown in Figure 45. Keep the SYNC pin low until all 32 bits are clocked into their respective serial registers. The SYNC pin is then pulled high to complete the operation.

To prevent data from mislocking (for example, due to noise) the part includes an internal counter, if the SCLK falling edges count is not a multiple of 8, the part ignores the command. A valid clock count is 16, 24, 32, 40, and so on. The counter resets when SYNC returns high.

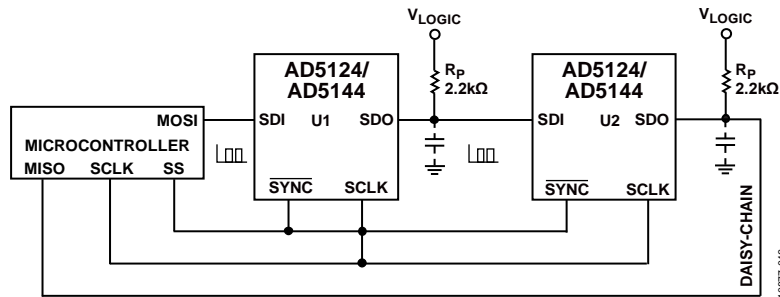

Figure 44. Daisy-Chain Configuration



Figure 45. Daisy-Chain Diagram

I²C SERIAL DATA INTERFACE

The AD5144/AD5144A have 2-wire, I²C-compatible serial interfaces. These devices can be connected to an I²C bus as a slave device, under the control of a master device. See Figure 5 for a timing diagram of a typical write sequence.

The AD5144/AD5144A support standard (100 kHz) and fast (400 kHz) data transfer modes. Support is not provided for 10-bit addressing and general call addressing.

The 2-wire serial bus protocol operates as follows:

1. The master initiates a data transfer by establishing a start condition, which is when a high-to-low transition on the SDA line occurs while SCL is high. The following byte is the address byte, which consists of the 7-bit slave address and an R/W bit. The slave device corresponding to the transmitted address responds by pulling SDA low during the ninth clock pulse (this is called the acknowledge bit). At this stage, all other devices on the bus remain idle while the selected device waits for data to be written to, or read from, its shift register.
If the R/W bit is set high, the master reads from the slave device. However, if the R/W bit is set low, the master writes to the slave device.
2. Data is transmitted over the serial bus in sequences of nine clock pulses (eight data bits followed by an acknowledge bit). The transitions on the SDA line must occur during the low period of SCL and remain stable during the high period of SCL.
3. When all data bits have been read from or written to, a stop condition is established. In write mode, the master pulls the SDA line high during the tenth clock pulse to establish a stop condition. In read mode, the master issues a no acknowledge for the ninth clock pulse (that is, the SDA line remains high). The master then brings the SDA line low before the tenth clock pulse, and then high again during the tenth clock pulse to establish a stop condition.

I²C ADDRESS

The AD5144/AD5144A each have two different device address options available (see Table 12 and Table 13).

Table 12. 20-Lead TSSOP Device Address Selection

| ADDR | 7-Bit I ² C Device Address |
|-------------------------|---------------------------------------|
| V _{LOGIC} | 0101000 |
| No connect ¹ | 0101010 |
| GND | 0101011 |

¹ Not available in bipolar mode (V_{SS} < 0 V) or in low voltage mode (V_{LOGIC} = 1.8 V).

Table 13. 24-Lead LFCSP Device Address Selection

| ADDR0 Pin | ADDR1 Pin | 7-Bit I ² C Device Address |
|-------------------------|-------------------------|---------------------------------------|
| V _{LOGIC} | V _{LOGIC} | 0100000 |
| No connect ¹ | V _{LOGIC} | 0100010 |
| GND | V _{LOGIC} | 0100011 |
| V _{LOGIC} | No connect ¹ | 0101000 |
| No connect ¹ | No connect ¹ | 0101010 |
| GND | No connect ¹ | 0101011 |
| V _{LOGIC} | GND | 0101100 |
| No connect ¹ | GND | 0101110 |
| GND | GND | 0101111 |

¹ Not available in bipolar mode (V_{SS} < 0 V) or in low voltage mode (V_{LOGIC} = 1.8 V).

Table 14. Reduced Commands Operation Truth Table

| Command Number | Control Bits[DB15:DB12] | | | | Address Bits[DB11:DB8] ¹ | | | | Data Bits[DB7:DB0] ¹ | | | | | | | | Operation | | |
|----------------|-------------------------|----|----|----|-------------------------------------|----|----|----|---------------------------------|----|----|----|----|----|----|-----------------|--|------------------|-------------|
| | C3 | C2 | C1 | C0 | A3 | A2 | A1 | A0 | D7 | D6 | D5 | D4 | D3 | D2 | D1 | D0 | | | |
| 0 | 0 | 0 | 0 | 0 | X | X | X | X | X | X | X | X | X | X | X | X | NOP: do nothing. | | |
| 1 | 0 | 0 | 0 | 1 | 0 | 0 | A1 | A0 | D7 | D6 | D5 | D4 | D3 | D2 | D1 | D0 ² | Write contents of serial register data to RDAC | | |
| 2 | 0 | 0 | 1 | 0 | 0 | 0 | A1 | A0 | D7 | D6 | D5 | D4 | D3 | D2 | D1 | D0 ² | Write contents of serial register data to input register | | |
| 3 | 0 | 0 | 1 | 1 | X | 0 | A1 | A0 | X | X | X | X | X | X | D1 | D0 | Read back contents | | |
| | | | | | | | | | | | | | | | | | D1 | D0 | Data |
| | | | | | | | | | | | | | | | | | 0 | 1 | EEPROM |
| | | | | | | | | | | | | | | | | | 1 | 1 | RDAC |
| 9 | 0 | 1 | 1 | 1 | 0 | 0 | A1 | A0 | X | X | X | X | X | X | X | 1 | Copy RDAC register to EEPROM | | |
| 10 | 0 | 1 | 1 | 1 | 0 | 0 | A1 | A0 | X | X | X | X | X | X | X | 0 | Copy EEPROM into RDAC | | |
| 14 | 1 | 0 | 1 | 1 | X | X | X | X | X | X | X | X | X | X | X | X | Software reset | | |
| 15 | 1 | 1 | 0 | 0 | A3 | 0 | A1 | A0 | X | X | X | X | X | X | X | D0 | Software shutdown | | |
| | | | | | | | | | | | | | | | | | D0 | Condition | |
| | | | | | | | | | | | | | | | | | 0 | Normal mode | |
| | | | | | | | | | | | | | | | | | 1 | Shutdown mode | |

¹X = don't care.

²D0 = don't care for AD5124.

Table 15. Reduced Address Bits Table

| A3 | A2 | A1 | A0 | Channel | Stored Channel Memory |
|----|----|----------------|----------------|--------------|-----------------------|
| 1 | 0 | X ¹ | X ¹ | All channels | Not applicable |
| 0 | 0 | 0 | 0 | RDAC1 | RDAC1 |
| 0 | 0 | 0 | 1 | RDAC2 | RDAC2 |
| 0 | 0 | 1 | 0 | RDAC3 | RDAC3 |
| 0 | 0 | 1 | 1 | RDAC4 | RDAC4 |

¹X = don't care.

ADVANCED CONTROL MODES

The AD5124/AD5144/AD5144A digital potentiometers include a set of user programming features to address the wide number of applications for these universal adjustment devices (see Table 20 and Table 22).

Key programming features include the following:

- Input register
- Linear gain setting mode
- Low wiper resistance feature
- Linear increment and decrement instructions
- ± 6 dB increment and decrement instructions
- Burst mode (I²C only)
- Reset
- Shutdown mode

Input Register

The AD5124/AD5144/AD5144A include one input register per RDAC register. These registers allow preloading of the value for the associated RDAC register. These registers can be written to using Command 2 and read back from using Command 3 (see Table 20).

This feature allows a synchronous and asynchronous update of one or all of the RDAC registers at the same time.

The transfer from the input register to the RDAC register is done asynchronously by the LRDAC pin or synchronously by Command 8 (see Table 20).

If new data is loaded into an RDAC register, this RDAC register automatically overwrites the associated input register.

Linear Gain Setting Mode

The proprietary architecture of the AD5124/AD5144/AD5144A allows the independent control of each string resistor, R_{AW} , and R_{WB} . To enable this feature, use Command 16 (see Table 20) to set Bit D2 of the control register (see Table 22).

This mode of operation can control the potentiometer as two independent rheostats connected at a single point, the W terminal.

This feature enables a second input and an RDAC register per channel, as shown in Table 21, but the actual RDAC contents remain unchanged. The same operations are valid for potentiometer and linear gain setting modes. The EEPROM commands affect the R_{WB} resistance only. The parts restores in potentiometer mode after a reset or power-up.

Low Wiper Resistance Feature

The AD5124/AD5144/AD5144A include two commands to reduce the wiper resistance between the terminals when the devices achieve full scale or zero scale. These extra positions are called bottom scale, BS, and top scale, TS. The resistance between Terminal A and Terminal W at top scale is specified as R_{TS} . Similarly, the bottom scale resistance between Terminal B and Terminal W is specified as R_{BS} .

The contents of the RDAC registers are unchanged by entering into these positions. There are three ways to exit from top scale and bottom scale: by using Command 12 or Command 13 (see Table 20); by loading new data in an RDAC register, which includes increment/decrement operations; or by entering shutdown mode, Command 15 (see Table 20).

Table 16 and Table 17 show the truth tables for the top scale position and the bottom scale position, respectively, when the potentiometer or linear gain setting mode is enabled.

Table 16. Top Scale Truth Table

| Linear Gain Setting Mode | | Potentiometer Mode | |
|--------------------------|----------|--------------------|----------|
| R_{AW} | R_{WB} | R_{AW} | R_{WB} |
| R_{AB} | R_{AB} | R_{TS} | R_{AB} |

Table 17. Bottom Scale Truth Table

| Linear Gain Setting Mode | | Potentiometer Mode | |
|--------------------------|----------|--------------------|----------|
| R_{AW} | R_{WB} | R_{AW} | R_{WB} |
| R_{TS} | R_{BS} | R_{AB} | R_{BS} |

Linear Increment and Decrement Instructions

The increment and decrement commands (Command 4 and Command 5 in Table 20) are useful for linear step adjustment applications. These commands simplify microcontroller software coding by allowing the controller to send an increment or decrement command to the device. The adjustment can be individual or in a ganged potentiometer arrangement, where all wiper positions are changed at the same time.

For an increment command, executing Command 4 automatically moves the wiper to the next RDAC position. This command can be executed in a single channel or multiple channels.

±6 dB Increment and Decrement Instructions

Two programming instructions produce logarithmic taper increment or decrement of the wiper position control by an individual potentiometer or by a ganged potentiometer arrangement where all RDAC register positions are changed simultaneously. The +6 dB increment is activated by Command 6, and the –6 dB decrement is activated by Command 7 (see Table 20). For example, starting with the zero-scale position and executing Command 6 ten times moves the wiper in 6 dB steps to the full-scale position. When the wiper position is near the maximum setting, the last 6 dB increment instruction causes the wiper to go to the full-scale position (see Table 18).

Incrementing the wiper position by +6 dB essentially doubles the RDAC register value, whereas decrementing the wiper position by –6 dB halves the register value. Internally, the AD5124/AD5144/AD5144A use shift registers to shift the bits left and right to achieve a ±6 dB increment or decrement. These functions are useful for various audio/video level adjustments, especially for white LED brightness settings in which human visual responses are more sensitive to large adjustments than to small adjustments.

Table 18. Detailed Left Shift and Right Shift Functions for the ±6 dB Step Increment and Decrement

| Left Shift (+6 dB/Step) | Right Shift (–6 dB/Step) |
|-------------------------|--------------------------|
| 0000 0000 | 1111 1111 |
| 0000 0001 | 0111 1111 |
| 0000 0010 | 0011 1111 |
| 0000 0100 | 0001 1111 |
| 0000 1000 | 0000 1111 |
| 0001 0000 | 0000 0111 |
| 0010 0000 | 0000 0011 |
| 0100 0000 | 0000 0001 |
| 1000 0000 | 0000 0000 |
| 1111 1111 | 0000 0000 |

Burst Mode (I²C Only)

By enabling the burst mode, multiple data bytes can be sent to the part consecutively. After the command byte, the part interprets the following consecutive bytes as data bytes for the command.

A new command can be sent by generating a repeat start or by a stop and start condition.

The burst mode is activated by setting Bit D3 of the control register (see Table 22).

Reset

The AD5124/AD5144/AD5144A can be reset through software by executing Command 14 (see Table 20) or through hardware on the low pulse of the RESET pin. The reset command loads the RDAC register with the contents of the EEPROM and takes approximately 30 μs. The EEPROM is preloaded to midscale at the factory, and initial power-up is, accordingly, at midscale. Tie RESET to V_{DD} if the RESET pin is not used.

Shutdown Mode

The AD5124/AD5144/AD5144A can be placed in shutdown mode by executing the software shutdown command, Command 15 (see Table 20), and setting the LSB (D0) to 1. This feature places the RDAC in a zero power consumption state where the device operates in potentiometer mode, Terminal A is open circuited, and the wiper, Terminal W, is connected to Terminal B; however, a finite wiper resistance of 40 Ω is present. When the device is configured in linear gain setting mode, the resistor addressed, R_{AW} or R_{WB}, is internally placed at high impedance. Table 19 shows a truth table depending on the device operating mode. The contents of the RDAC register are unchanged by entering shutdown mode. However, all commands listed in Table 20 are supported while in shutdown mode. Execute Command 15 (see Table 20) and set the LSB (D0) to 0 to exit shutdown mode.

Table 19. Shutdown Mode Truth Table

| Linear Gain Setting Mode | | Potentiometer Mode | |
|--------------------------|-----------------|--------------------|-----------------|
| R _{AW} | R _{WB} | R _{AW} | R _{WB} |
| High impedance | High impedance | High impedance | R _{BS} |

EEPROM OR RDAC REGISTER PROTECTION

The EEPROM and RDAC registers can be protected by disabling any update to these registers. This can be done by using software or by using hardware. If these registers are protected by software, set Bit D0 and/or Bit D1 (see Table 22), which protects the RDAC and EEPROM registers independently.

If the registers are protected by hardware, pull the $\overline{\text{WP}}$ pin low (only available in the LFCSP package). If the $\overline{\text{WP}}$ pin is pulled low when the part is executing a command, the protection is not enabled until the command is completed (only available in the LFCSP package).

When RDAC is protected, the only operation allowed is to copy the EEPROM into the RDAC register.

LOAD RDAC INPUT REGISTER (LRDAC)

LRDAC software or hardware transfers data from the input register to the RDAC register (and therefore updates the wiper position). By default, the input register has the same value as the RDAC register; therefore, only the input register that has been updated using Command 2 is updated.

Software $\overline{\text{LRDAC}}$, Command 8, allows updating of a single RDAC register or all of the channels at once (see Table 20). This is a synchronous update.

The hardware $\overline{\text{LRDAC}}$ is completely asynchronous and copies the content of all the input registers into the associated RDAC registers. If a command is being executed, any transition in the LRDAC pin is ignored by the part to avoid data corruption.

Table 20. Advance Commands Operation Truth Table

| Command Number | Control Bits[DB15:DB12] | | | | Address Bits[DB11:DB8] ¹ | | | | Data Bits[DB7:DB0] ¹ | | | | | | | | Operation | | |
|----------------|-------------------------|------------------|------|----|-------------------------------------|----|----|----|---------------------------------|----|----|----|----|----|----|---|--|-----------|----------------|
| | C3 | C2 | C1 | C0 | A3 | A2 | A1 | A0 | D7 | D6 | D5 | D4 | D3 | D2 | D1 | D0 | | | |
| 0 | 0 | 0 | 0 | 0 | X | X | X | X | X | X | X | X | X | X | X | X | NOP: do nothing | | |
| 1 | 0 | 0 | 0 | 1 | A3 | A2 | A1 | A0 | D7 | D6 | D5 | D4 | D3 | D2 | D1 | D0 ² | Write contents of serial register data to RDAC | | |
| 2 | 0 | 0 | 1 | 0 | A3 | A2 | A1 | A0 | D7 | D6 | D5 | D4 | D3 | D2 | D1 | D0 ² | Write contents of serial register data to input register | | |
| 3 | 0 | 0 | 1 | 1 | X | A2 | A1 | A0 | X | X | X | X | X | X | D1 | D0 | Read back contents | | |
| | | | | | | | | | | | | | | | | | D1 | D0 | Data |
| | | | | | | | | | | | | | | | | | 0 | 0 | Input register |
| | | | | | | | | | | | | | | | | | 0 | 1 | EEPROM |
| 1 | 0 | Control register | | | | | | | | | | | | | | | | | |
| 1 | 1 | 1 | RDAC | | | | | | | | | | | | | | | | |
| 4 | 0 | 1 | 0 | 0 | A3 | A2 | A1 | A0 | X | X | X | X | X | X | X | 1 | Linear RDAC increment | | |
| 5 | 0 | 1 | 0 | 0 | A3 | A2 | A1 | A0 | X | X | X | X | X | X | X | 0 | Linear RDAC decrement | | |
| 6 | 0 | 1 | 0 | 1 | A3 | A2 | A1 | A0 | X | X | X | X | X | X | X | 1 | +6 dB RDAC increment | | |
| 7 | 0 | 1 | 0 | 1 | A3 | A2 | A1 | A0 | X | X | X | X | X | X | X | 0 | -6 dB RDAC decrement | | |
| 8 | 0 | 1 | 1 | 0 | A3 | A2 | A1 | A0 | X | X | X | X | X | X | X | X | Copy input register to RDAC (software LRDAC) | | |
| 9 | 0 | 1 | 1 | 1 | 0 | 0 | A1 | A0 | X | X | X | X | X | X | X | 1 | Copy RDAC register to EEPROM | | |
| 10 | 0 | 1 | 1 | 1 | 0 | 0 | A1 | A0 | X | X | X | X | X | X | X | 0 | Copy EEPROM into RDAC | | |
| 11 | 1 | 0 | 0 | 0 | 0 | 0 | A1 | A0 | D7 | D6 | D5 | D4 | D3 | D2 | D1 | D0 ² | Write contents of serial register data to EEPROM | | |
| 12 | 1 | 0 | 0 | 1 | A3 | A2 | A1 | A0 | 1 | X | X | X | X | X | X | D0 | Top scale D0 = 1; enter D0 = 0; exit | | |
| 13 | 1 | 0 | 0 | 1 | A3 | A2 | A1 | A0 | 0 | X | X | X | X | X | X | D0 | Bottom scale D0 = 1; enter D0 = 0; exit | | |
| 14 | 1 | 0 | 1 | 1 | X | X | X | X | X | X | X | X | X | X | X | X | Software reset | | |
| 15 | 1 | 1 | 0 | 0 | A3 | A2 | A1 | A0 | X | X | X | X | X | X | X | D0 | Software shutdown D0 = 0; normal mode D0 = 1; device placed in shutdown mode | | |
| 16 | 1 | 1 | 0 | 1 | X | X | X | X | X | X | X | D3 | D2 | D1 | D0 | Copy serial register data to control register | | | |

¹ X = don't care.² D0 = don't care for AD5124.

Table 21. Address Bits

| A3 | A2 | A1 | A0 | Potentiometer Mode | | Linear Gain Setting Mode | | Stored RDAC Memory |
|----|----------------|----------------|----------------|--------------------|----------------|--------------------------|------------------|--------------------|
| | | | | Input Register | RDAC Register | Input Register | RDAC Register | |
| 1 | X ¹ | X ¹ | X ¹ | All channels | All channels | All channels | All channels | Not applicable |
| 0 | 0 | 0 | 0 | RDAC1 | RDAC1 | R _{WB1} | R _{WB1} | RDAC1 |
| 0 | 1 | 0 | 0 | Not applicable | Not applicable | R _{AW1} | R _{AW1} | Not applicable |
| 0 | 0 | 0 | 1 | RDAC2 | RDAC2 | R _{WB2} | R _{WB2} | RDAC2 |
| 0 | 1 | 0 | 1 | Not applicable | Not applicable | R _{AW2} | R _{AW2} | Not applicable |
| 0 | 0 | 1 | 0 | RDAC3 | RDAC3 | R _{WB3} | R _{WB3} | RDAC3 |
| 0 | 1 | 1 | 0 | Not applicable | Not applicable | R _{AW3} | R _{AW3} | Not applicable |
| 0 | 0 | 1 | 1 | RDAC4 | RDAC4 | R _{WB4} | R _{WB4} | RDAC4 |
| 0 | 1 | 1 | 1 | Not applicable | Not applicable | R _{AW4} | R _{AW4} | Not applicable |

¹X = don't care.

Table 22. Control Register Bit Descriptions

| Bit Name | Description |
|----------|---|
| D0 | RDAC register write protect 0 = wiper position frozen to value in EEPROM memory 1 = allows update of wiper position through digital interface (default) |
| D1 | EEPROM program enable 0 = EEPROM program disabled 1 = enables device for EEPROM program (default) |
| D2 | Linear setting mode/potentiometer mode 0 = potentiometer mode (default) 1 = linear gain setting mode |
| D3 | Burst mode (I ² C only) 0 = disabled (default) 1 = enabled (no disable after stop or repeat start condition) |

RDAC ARCHITECTURE

To achieve optimum performance, Analog Devices, Inc., has proprietary RDAC segmentation architecture for all the digital potentiometers. In particular, the AD5124/AD5144 employ a three-stage segmentation approach, as shown in Figure 46. The AD5124/AD5144/AD5144A wiper switch is designed with the transmission gate CMOS topology and with the gate voltage derived from V_{DD} and V_{SS} .



Figure 46. AD5124/AD5144/AD5144A Simplified RDAC Circuit

Top Scale/Bottom Scale Architecture

In addition, the AD5124/AD5144/AD5144A include new positions to reduce the resistance between terminals. These positions are called bottom scale and top scale. At bottom scale, the typical wiper resistance decreases from 130 Ω to 60 Ω ($R_{AB} = 100$ k Ω). At top scale, the resistance between Terminal A and Terminal W is decreased by 1 LSB, and the total resistance is reduced to 60 Ω ($R_{AB} = 100$ k Ω).

PROGRAMMING THE VARIABLE RESISTOR

Rheostat Operation— $\pm 8\%$ Resistor Tolerance

The AD5124/AD5144/AD5144A operate in rheostat mode when only two terminals are used as a variable resistor. The unused terminal can be floating, or it can be tied to Terminal W, as shown in Figure 47.



Figure 47. Rheostat Mode Configuration

The nominal resistance between Terminal A and Terminal B, R_{AB} , is 10 k Ω or 100 k Ω , and has 128/256 tap points accessed by the wiper terminal. The 7-bit/8-bit data in the RDAC latch is decoded to select one of the 128/256 possible wiper settings. The general equations for determining the digitally programmed output resistance between Terminal W and Terminal B are

AD5124:

$$R_{WB}(D) = \frac{D}{128} \times R_{AB} + R_W \quad \text{From } 0x00 \text{ to } 0x7F \quad (1)$$

AD5144/AD5144A:

$$R_{WB}(D) = \frac{D}{256} \times R_{AB} + R_W \quad \text{From } 0x00 \text{ to } 0xFF \quad (2)$$

where:

D is the decimal equivalent of the binary code in the 7-bit/8-bit RDAC register.

R_{AB} is the end-to-end resistance.

R_W is the wiper resistance.

In potentiometer mode, similar to the mechanical potentiometer, the resistance between Terminal W and Terminal A also produces a digitally controlled complementary resistance, R_{WA} . R_{WA} also gives a maximum of 8% absolute resistance error. R_{WA} starts at the maximum resistance value and decreases as the data loaded into the latch increases. The general equations for this operation are

AD5124:

$$R_{AW}(D) = \frac{128 - D}{128} \times R_{AB} + R_W \quad \text{From } 0x00 \text{ to } 0x7F \quad (3)$$

AD5144/AD5144A:

$$R_{AW}(D) = \frac{256 - D}{256} \times R_{AB} + R_W \quad \text{From } 0x00 \text{ to } 0xFF \quad (4)$$

where:

D is the decimal equivalent of the binary code in the 7-bit/8-bit RDAC register.

R_{AB} is the end-to-end resistance.

R_W is the wiper resistance.

If the part is configured in linear gain setting mode, the resistance between Terminal W and Terminal A is directly proportional to the code loaded in the associate RDAC register. The general equations for this operation are

AD5124:

$$R_{WB}(D) = \frac{D}{128} \times R_{AB} + R_W \quad \text{From } 0x00 \text{ to } 0x7F \quad (5)$$

AD5144/AD5144A:

$$R_{WB}(D) = \frac{D}{256} \times R_{AB} + R_W \quad \text{From } 0x00 \text{ to } 0xFF \quad (6)$$

where:

D is the decimal equivalent of the binary code in the 7-bit/8-bit RDAC register.

R_{AB} is the end-to-end resistance.

R_W is the wiper resistance.

In the bottom scale condition or top scale condition, a finite total wiper resistance of 40 Ω is present. Regardless of which setting the part is operating in, limit the current between Terminal A to Terminal B, Terminal W to Terminal A, and Terminal W to Terminal B to the maximum continuous current of ± 6 mA or to the pulse current specified in Table 7. Otherwise, degradation or possible destruction of the internal switch contact can occur.

PROGRAMMING THE POTENTIOMETER DIVIDER

Voltage Output Operation

The digital potentiometer easily generates a voltage divider at wiper-to-B and wiper-to-A that is proportional to the input voltage at A to B, as shown in Figure 48.



Figure 48. Potentiometer Mode Configuration

Connecting Terminal A to 5 V and Terminal B to ground produces an output voltage at the Wiper W to Terminal B ranging from 0 V to 5 V. The general equation defining the output voltage at V_W with respect to ground for any valid input voltage applied to Terminal A and Terminal B is

$$V_W(D) = \frac{R_{WB}(D)}{R_{AB}} \times V_A + \frac{R_{AW}(D)}{R_{AB}} \times V_B \quad (7)$$

where:

$R_{WB}(D)$ can be obtained from Equation 1 and Equation 2.

$R_{AW}(D)$ can be obtained from Equation 3 and Equation 4.

Operation of the digital potentiometer in the divider mode results in a more accurate operation over temperature. Unlike the rheostat mode, the output voltage is dependent mainly on the ratio of the internal resistors, R_{AW} and R_{WB} , and not the absolute values. Therefore, the temperature drift reduces to 5 ppm/ $^{\circ}\text{C}$.

TERMINAL VOLTAGE OPERATING RANGE

The AD5124/AD5144/AD5144A are designed with internal ESD diodes for protection. These diodes also set the voltage boundary of the terminal operating voltages. Positive signals present on Terminal A, Terminal B, or Terminal W that exceed V_{DD} are clamped by the forward-biased diode. There is no polarity constraint between V_A , V_W , and V_B , but they cannot be higher than V_{DD} or lower than V_{SS} .



Figure 49. Maximum Terminal Voltages Set by V_{DD} and V_{SS}

POWER-UP SEQUENCE

Because there are diodes to limit the voltage compliance at Terminal A, Terminal B, and Terminal W (see Figure 49), it is important to power up V_{DD} first before applying any voltage to Terminal A, Terminal B, and Terminal W. Otherwise, the diode is forward-biased such that V_{DD} is powered unintentionally. The ideal power-up sequence is V_{SS} , V_{DD} , V_{LOGIC} , digital inputs, and V_A , V_B , and V_W . The order of powering V_A , V_B , V_W , and digital inputs is not important as long as they are powered after V_{SS} , V_{DD} , and V_{LOGIC} . Regardless of the power-up sequence and the ramp rates of the power supplies, once V_{DD} is powered, the power-on preset activates, which restores EEPROM values to the RDAC registers.

LAYOUT AND POWER SUPPLY BIASING

It is always a good practice to use a compact, minimum lead length layout design. Ensure that the leads to the input are as direct as possible with a minimum conductor length. Ground paths should have low resistance and low inductance. It is also good practice to bypass the power supplies with quality capacitors. Apply low equivalent series resistance (ESR) 1 μF to 10 μF tantalum or electrolytic capacitors at the supplies to minimize any transient disturbance and to filter low frequency ripple. Figure 50 illustrates the basic supply bypassing configuration for the AD5124/AD5144/AD5144A.



Figure 50. Power Supply Bypassing

OUTLINE DIMENSIONS



COMPLIANT TO JEDEC STANDARDS MO-220-WGGD-8

Figure 51. 24-Lead Lead Frame Chip Scale Package [LFCSP]
4 mm × 4 mm Body and 0.75 mm Package Height
(CP-24-10)
Dimensions shown in millimeters

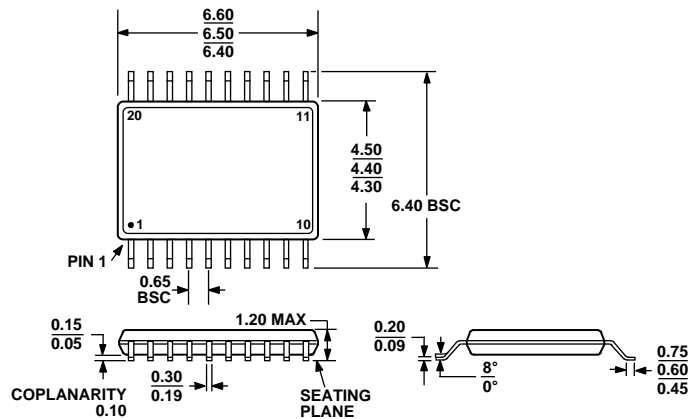

Figure 52. 20-Lead Thin Shrink Small Outline Package [TSSOP]
(RU-20)
Dimensions shown in millimeters

ORDERING GUIDE

| Model ^{1, 2} | R _{AB} (kΩ) | Resolution | Interface | Temperature Range | Package Description | Package Option |
|-----------------------|----------------------|------------|----------------------|-------------------|---------------------|----------------|
| AD5124BCPZ10-RL7 | 10 | 128 | SPI/I ² C | −40°C to +125°C | 24-Lead LFCSP | CP-24-10 |
| AD5124BCPZ100-RL7 | 100 | 128 | SPI/I ² C | −40°C to +125°C | 24-Lead LFCSP | CP-24-10 |
| AD5124BRUZ10 | 10 | 128 | SPI | −40°C to +125°C | 20-Lead TSSOP | RU-20 |
| AD5124BRUZ100 | 100 | 128 | SPI | −40°C to +125°C | 20-Lead TSSOP | RU-20 |
| AD5124BRUZ10-RL7 | 10 | 128 | SPI | −40°C to +125°C | 20-Lead TSSOP | RU-20 |
| AD5124BRUZ100-RL7 | 100 | 128 | SPI | −40°C to +125°C | 20-Lead TSSOP | RU-20 |
| AD5144BCPZ10-RL7 | 10 | 256 | SPI/I ² C | −40°C to +125°C | 24-Lead LFCSP | CP-24-10 |
| AD5144BCPZ100-RL7 | 100 | 256 | SPI/I ² C | −40°C to +125°C | 24-Lead LFCSP | CP-24-10 |
| AD5144BRUZ10 | 10 | 256 | SPI | −40°C to +125°C | 20-Lead TSSOP | RU-20 |
| AD5144BRUZ100 | 100 | 256 | SPI | −40°C to +125°C | 20-Lead TSSOP | RU-20 |
| AD5144BRUZ10-RL7 | 10 | 256 | SPI | −40°C to +125°C | 20-Lead TSSOP | RU-20 |
| AD5144BRUZ100-RL7 | 100 | 256 | SPI | −40°C to +125°C | 20-Lead TSSOP | RU-20 |
| AD5144ABRUZ10 | 10 | 256 | I ² C | −40°C to +125°C | 20-Lead TSSOP | RU-20 |
| AD5144ABRUZ100 | 100 | 256 | I ² C | −40°C to +125°C | 20-Lead TSSOP | RU-20 |
| AD5144ABRUZ10-RL7 | 10 | 256 | I ² C | −40°C to +125°C | 20-Lead TSSOP | RU-20 |
| AD5144ABRUZ100-RL7 | 100 | 256 | I ² C | −40°C to +125°C | 20-Lead TSSOP | RU-20 |
| EVAL-AD5144DBZ | | | | | Evaluation Board | |

¹ Z = RoHS Compliant Part.² The evaluation board is shipped with the 10 kΩ R_{AB} resistor option; however, the board is compatible with both of the available resistor value options.

NOTES

NOTES

I²C refers to a communications protocol originally developed by Philips Semiconductors (now NXP Semiconductors).