



■ Features

- 180~295VAC input range
- Built-in active PFC function
- No load power consumption <0.5W
- High efficiency up to 92%
- Fanless design, cooling by free air convection
- IP67 / IP65 design for indoor or outdoor installations
- Output current adjustable through output cable or internal potentiometer
- Built-in 3 in 1 dimming function for B-Type (0~10Vdc or 10V PWM signal or resistance)
- Protections: Short circuit / Overload / Over voltage / Over temperature
- Suitable for dry / damp / wet locations
- Type "HL" for use in class I , Division 2 hazardous(Classified) location luminaires
- 5 years warranty(Note.6)

■ Applications

- LED street lighting
- LED harbor lighting
- LED bay lighting
- LED greenhouse lighting
- Class I , Division 2 hazardous (Classified) location luminaires

■ Description

ELG-150-C series is a 150W LED AC/DC power supply featuring the constant current mode and high voltage output. ELG-150-C operates from 180~295VAC and offers models with different rated current ranging between 500mA and 2100mA. Thanks to the high efficiency up to 92%, with the fanless design, the entire series is able to operate between -40°C and +70°C under free air convection. The design of metal housing and IP67/IP65 ingress protection level allows this series to fit both indoor and outdoor applications. ELG-150-C is equipped with various function options, such as dimming methodologies, so as to provide the optimal design flexibility for lighting system.

■ Model Encoding

ELG - 150 - C700 A

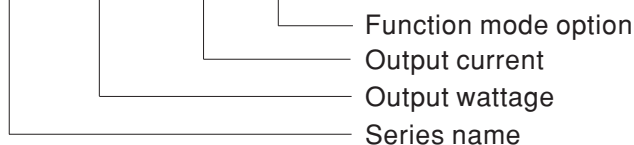

- Blank : Standard model, IP67, constant current level fixed
- A : Standard model, IP65, constant current level adjustable through internal potentiometer
- B : Standard model, IP67, constant current level adjustable with additive 0~10Vdc, 10V PWM signal or resistance
- D: Optional model, IP67, Smart timer dimming function. Please contact MEAN WELL for details.
- DA: Optional model, IP67, DALI function. Please contact MEAN WELL for details.



SPECIFICATION

MODEL		ELG-150-C500 <input type="checkbox"/>	ELG-150-C700 <input type="checkbox"/>	ELG-150-C1050 <input type="checkbox"/>	ELG-150-C1400 <input type="checkbox"/>	ELG-150-C1750 <input type="checkbox"/> (Note.7)	ELG-150-C2100 <input type="checkbox"/> (Note.7)
OUTPUT	RATED CURRENT	500mA	700mA	1050mA	1400mA	1750mA	2100mA
	CONSTANT CURRENT REGION Note.4	150 ~ 300V	107 ~ 214V	72 ~ 143V	54 ~ 107V	43 ~ 86V	36 ~ 72V
	NO LOAD OUTPUT VOLTAGE (max.)	315V	225V	151V	115V	94V	80V
	RATED POWER	150W	149.8W	150.15W	149.8W	150.5W	151.2W
	RIPPLE CURRENT	±5.0%p-p					
	RIPPLE & NOISE (max.) Note.2	2Vp-p	1.5Vp-p	1.0Vp-p	1.0Vp-p	0.8Vp-p	0.8Vp-p
	CURRENT TOLERANCE	±5.0%					
	CURRENT ADJ. RANGE	Can be adjusted by internal potentiometer for A-Type only					
		250 ~ 500mA	350 ~ 700mA	525 ~ 1050mA	700 ~ 1400mA	875 ~ 1750mA	1050 ~ 2100mA
SETUP, RISE TIME	500ms, 85ms at full load 230VAC						
HOLD UP TIME (Typ.)	10ms at full load 230VAC						
INPUT	VOLTAGE RANGE Note.3	180 ~ 295VAC 255 ~ 417VDC					
	FREQUENCY RANGE	47 ~ 63Hz					
	POWER FACTOR	PF ≥ 0.95/230VAC PF ≥ 0.92/277VAC at full load (Please refer to "Power Factor Characteristic curve")					
	TOTAL HARMONIC DISTORTION	THD < 20% when output loading ≥ 50% at 230VAC input and output loading ≥ 75% at 277VAC input					
	EFFICIENCY (Typ.)	92%	92%	92%	91%	91%	91%
	AC CURRENT	0.9A / 230VAC 0.7A/277VAC					
	INRUSH CURRENT(Typ.)	COLD START 65A(twidth=485µs measured at 50% Ipeak) at 230VAC					
	MAX. No. of PSUs on 16A CIRCUIT BREAKER	3 units (circuit breaker of type B) / 6 units (circuit breaker of type C) at 230VAC					
	LEAKAGE CURRENT	<0.75mA / 277VAC					
PROTECTION	SHORT CIRCUIT	Hiccup mode, recovers automatically after fault condition is removed					
	OVER VOLTAGE	320 ~ 360V	230 ~ 265V	155 ~ 180V	128 ~ 150V	96 ~ 106V	82 ~ 92V
		Protection type : Shut down o/p voltage, re-power on to recovery					
	OVER TEMPERATURE	Shut down o/p voltage, re-power on to recovery					
ENVIRONMENT	WORKING TEMP.	-40 ~ +70°C (Refer to "Derating Curve")					
	WORKING HUMIDITY	20 ~ 95% RH non-condensing					
	STORAGE TEMP., HUMIDITY	-40 ~ +80°C, 10 ~ 95% RH					
	TEMP. COEFFICIENT	±0.03%/°C (0 ~ 50°C)					
	VIBRATION	10 ~ 500Hz, 5G 12min./1cycle, period for 72min. each along X, Y, Z axes					
SAFETY & EMC	SAFETY STANDARDS	UL8750(type"HL"), EN61347-1, EN61347-2-13 independent, IP65 or IP67 approved					
	WITHSTAND VOLTAGE	I/P-O/P:3.75KVAC I/P-FG:2.0KVAC O/P-FG:1.5KVAC					
	ISOLATION RESISTANCE	I/P-O/P, I/P-FG, O/P-FG:100M Ohms / 500VDC / 25°C / 70% RH					
	EMC EMISSION	Compliance to EN55015, EN61000-3-2 Class C (≥ 50% loading) ; EN61000-3-3					
	EMC IMMUNITY	Compliance to EN61000-4-2,3,4,5,6,8,11; EN61547, light industry level (surge 6KV)					
OTHERS	MTBF	308.5Khrs min. MIL-HDBK-217F (25°C)					
	DIMENSION	219*63*35.5 mm (L*W*H)					
	PACKING	0.85Kg; 16pcs / 14.6kg / 0.77CUFT					
NOTE	<ol style="list-style-type: none"> All parameters NOT specially mentioned are measured at 230VAC input, rated load and 25°C of ambient temperature. Ripple & noise are measured at 20MHz of bandwidth by using a 12" twisted pair-wire terminated with a 0.1uf & 47uf parallel capacitor. Derating may be needed under low input voltages. Please check the static characteristics for more details. Please refer to "DRIVING METHODS OF LED MODULE". The power supply is considered as a component that will be operated in combination with final equipment. Since EMC performance will be affected by the complete installation, the final equipment manufacturers must re-qualify EMC Directive on the complete installation again. Refer to warranty statement. ELG-150-C1750 and ELG-150-C2100 will be announced shortly. 						

■ Block Diagram

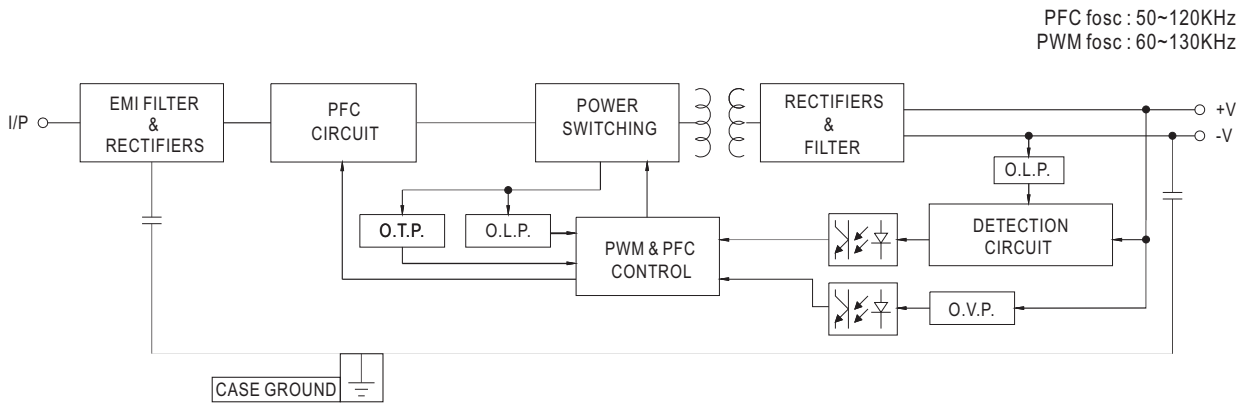

■ Derating Curve

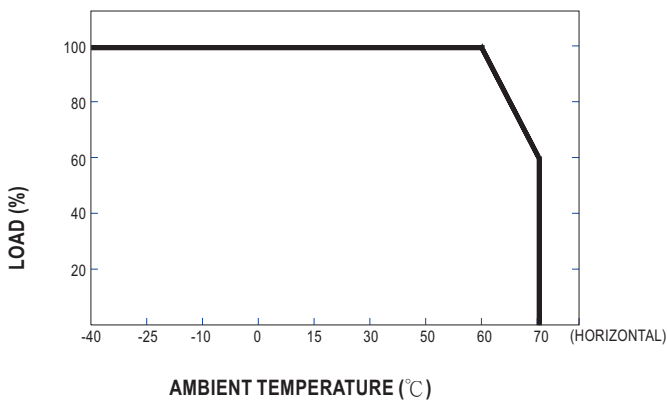

■ Static Characteristics

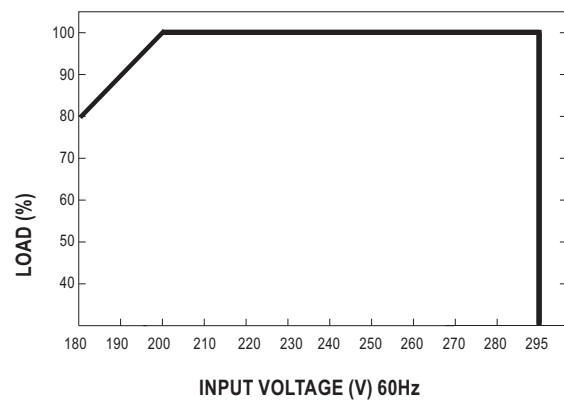

Power Factor Characteristic

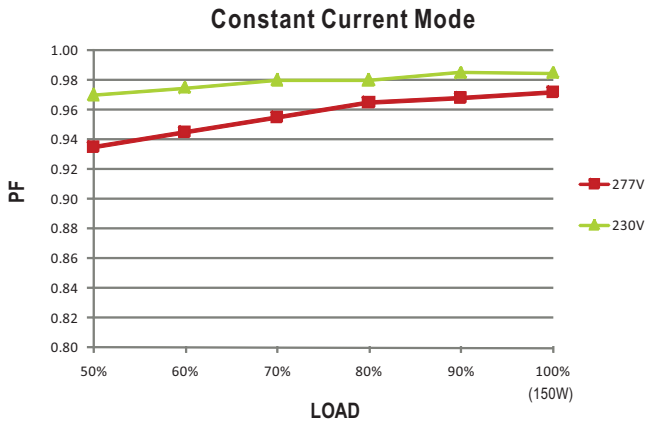

EFFICIENCY vs LOAD (500mA Model)

ELG-150-C series possess superior working efficiency that up to 92% can be reached in field applications.

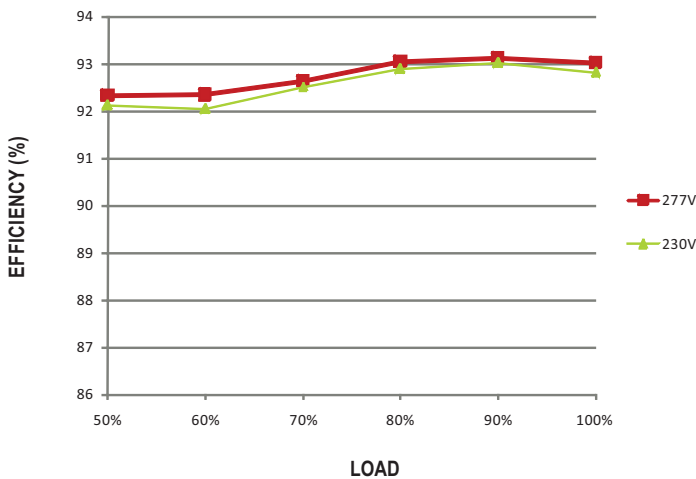

DRIVING METHODS OF LED MODULE

This LED power supply is suggested to work in constant current mode area (CC) to drive the LEDs.

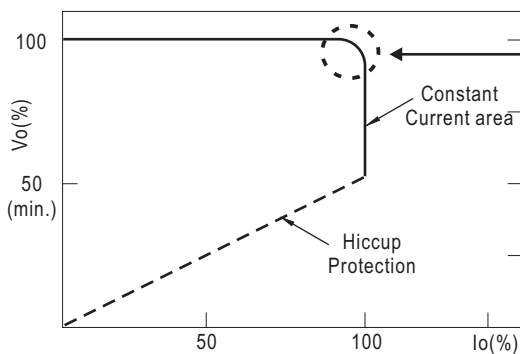

Typical LED power supply I-V curve

In the constant current region, the highest voltage at the output of the driver depends on the configuration of the end systems.
Should there be any compatibility issues, please contact MEAN WELL.

■ DIMMING OPERATION(for B-Type only)

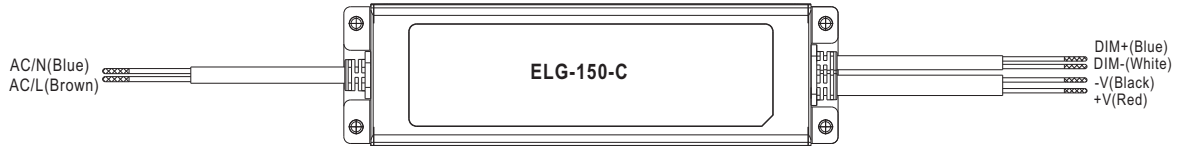

※ Built-in 3 in 1 dimming function, IP67 rated. Output constant current level can be adjusted through output cable by connecting a resistance or 0 ~ 10Vdc or 10V PWM signal between DIM+ and DIM-.

※ Please DO NOT connect "DIM-" to "-V".

※ Reference resistance value for output current adjustment (Typical)

Resistance value	Single driver	Short	10K Ω	20K Ω	30K Ω	40K Ω	50K Ω	60K Ω	70K Ω	80K Ω	90K Ω	100K Ω	OPEN
	Multiple drivers (N=driver quantity for synchronized dimming operation)	Short	10K Ω /N	20K Ω /N	30K Ω /N	40K Ω /N	50K Ω /N	60K Ω /N	70K Ω /N	80K Ω /N	90K Ω /N	100K Ω /N	-----
Percentage of rated current		0%	10%	20%	30%	40%	50%	60%	70%	80%	90%	100%	95%~108%

※ 0 ~ 10V dimming function for output current adjustment (Typical)

Dimming value	0V	1V	2V	3V	4V	5V	6V	7V	8V	9V	10V	OPEN
Percentage of rated current	0%	10%	20%	30%	40%	50%	60%	70%	80%	90%	100%	95%~108%

※ 10V PWM signal for output current adjustment (Typical): Frequency range : 100Hz ~ 3KHz

Duty value	0%	10%	20%	30%	40%	50%	60%	70%	80%	90%	100%	OPEN
Percentage of rated current	0%	10%	20%	30%	40%	50%	60%	70%	80%	90%	100%	95%~108%

◎ Dimming Characteristic

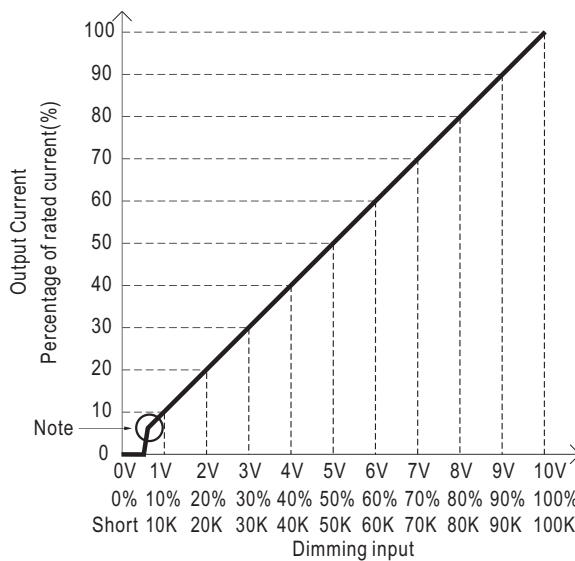

0~10V
Duty cycle of 10V PWM (frequency range = 100~3KHz)
Short~100K Ω resistance

※ Note : The output current drops down to 0% when the dimming input is about 6K Ω or 0.6Vdc, or 10V PWM signal with 6% duty cycle.

■ Mechanical Specification

CASE NO.:237A Unit:mm

Blank-Type:(ELG-150-C_)

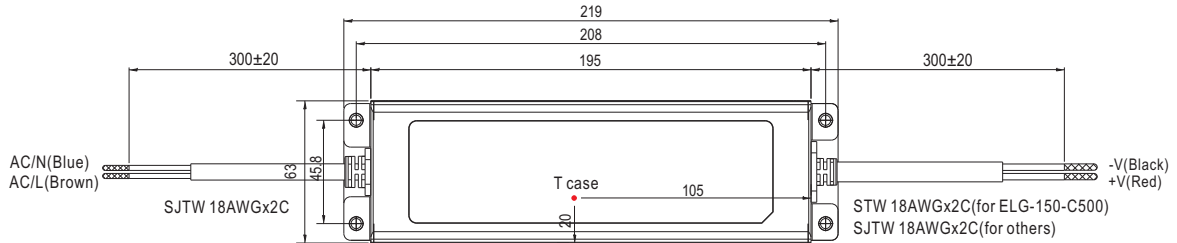

※ T case: Max. Case Temperature.



A-Type:(ELG-150-C500A/700A/1050A/1400A)

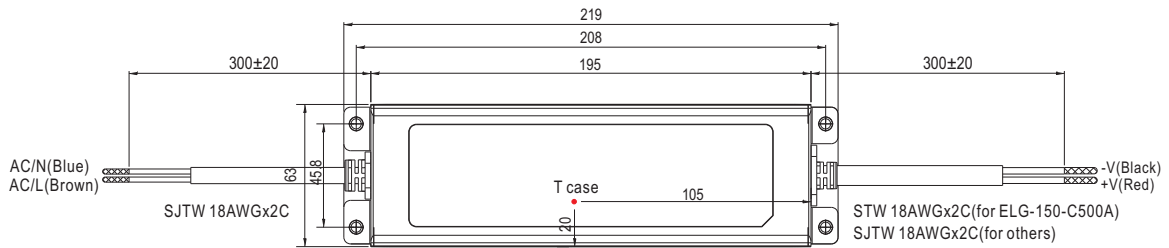

※ T case: Max. Case Temperature.

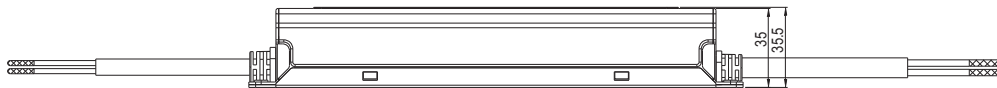

A-Type:(ELG-150-C1750A/2100A)

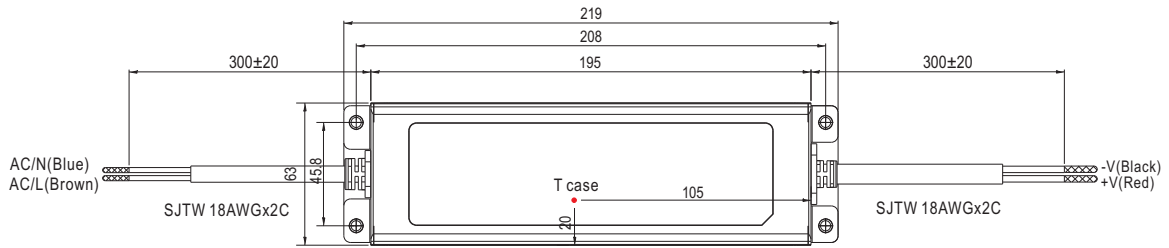

※ T case: Max. Case Temperature.

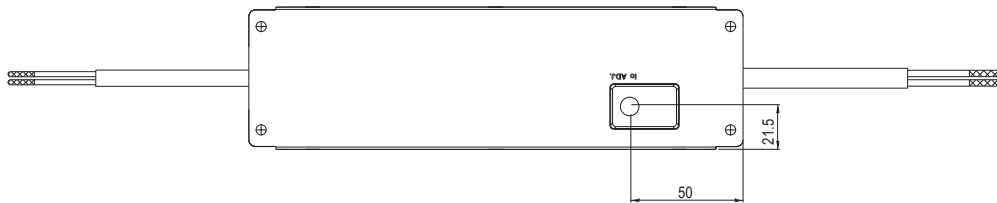

B-Type/DA-Type:(ELG-150-C_B,ELG-150-C_DA)

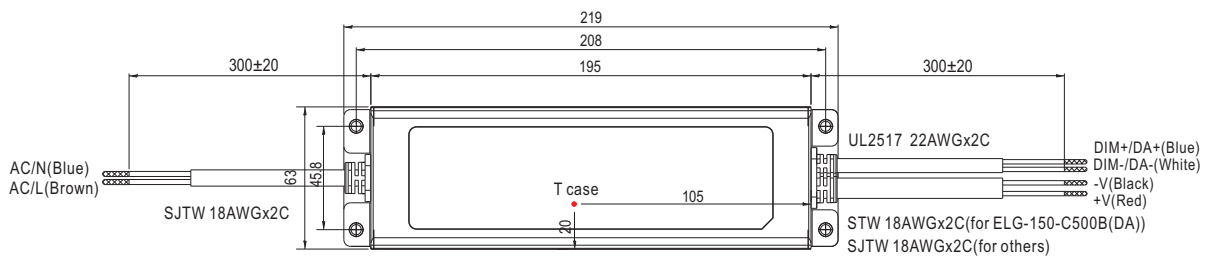

※ T case: Max. Case Temperature.

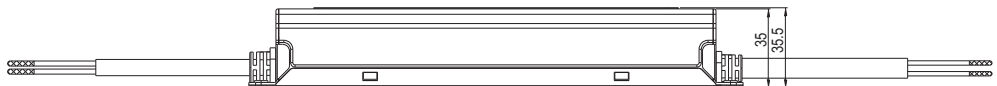

■ Installation Manual

Please refer to : <http://www.meanwell.com/webnet/search/InstallationSearch.html>