

SDARS External Antenna



AEACBD045015-S2332



45.2 x 35.8 x 15.1 mm
RoHS/RoHS II Compliant
MSL = N/A: Not Applicable

Features

- Low VSWR 1.5
- High gain 3 dBic
- Left-hand circular polarization
- Active antenna with integrated LNA
- High LNA gain of 34 dB
- IP67 rated
- Magnetic mounting

Applications

- Use with Satellite Digital Audio Radio Services (SDARS)
- Satellite Radios
- Digital Radio Service

Electrical Specifications

ANTENNA					
Parameters	Min.	Typ.	Max.	Units	Notes
Operating Frequency		2320 ~ 2345		MHz	
Bandwidth		25		MHz	
VSWR			1.5		
Gain		3		dBic	
Axial Ratio			3	dB	
Polarization		LHCP			
Impedance		50		Ω	
LNA					
LNA Gain		34 \pm 2		dB	
Noise Figure			1	dB	
VSWR			2		
Supply Voltage	3		5	V	DC
Current Consumption			40	mA	

SDARS External Antenna



AEACBD045015-S2332



45.2 x 35.8 x 15.1 mm
RoHS/RoHS II Compliant
MSL = N/A: Not Applicable

Mechanical Specifications

Parameters	Description
Cable Type	RG-174
Cable Length	3 m
Connector	SMA
Radome Material	ABS
Mounting Type	Magnet

Environmental Specifications

Parameters	Description
Operating Temperature	-40 °C to +85 °C
Relative Humidity	Up to 95 %
Ingress Protection	IP67
Vibration	10 ~ 55 Hz with 1.5 mm amplitude 2 hours

SDARS External Antenna



AEACBD045015-S2332



45.2 x 35.8 x 15.1 mm
RoHS/RoHS II Compliant
MSL = N/A: Not Applicable

Product Dimensions

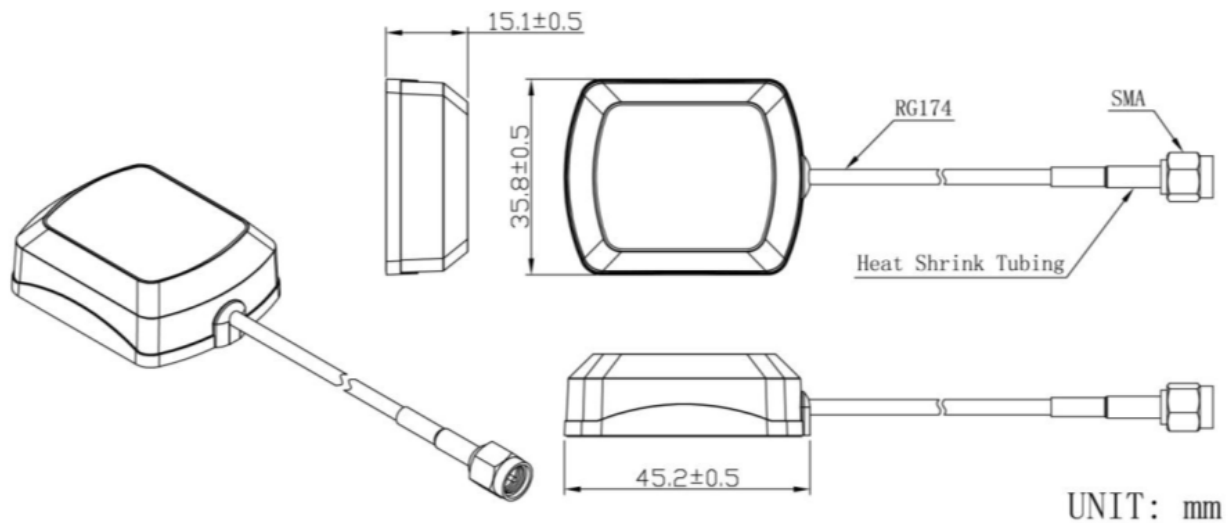

SDARS External Antenna



AEACBD045015-S2332



45.2 x 35.8 x 15.1 mm
RoHS/RoHS II Compliant
MSL = N/A: Not Applicable

Return Loss

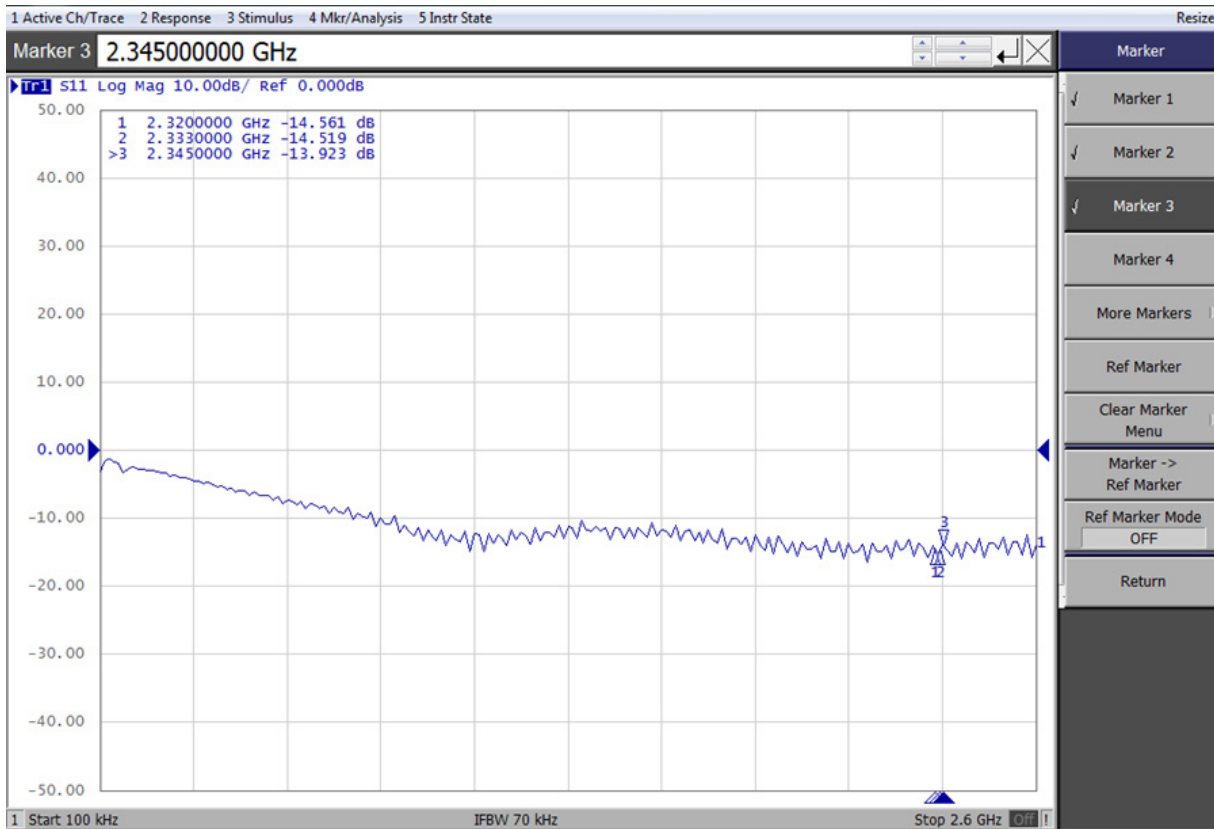

SDARS External Antenna



AEACBD045015-S2332



45.2 x 35.8 x 15.1 mm
RoHS/RoHS II Compliant
MSL = N/A: Not Applicable

Radiation Pattern

2D - Pattern

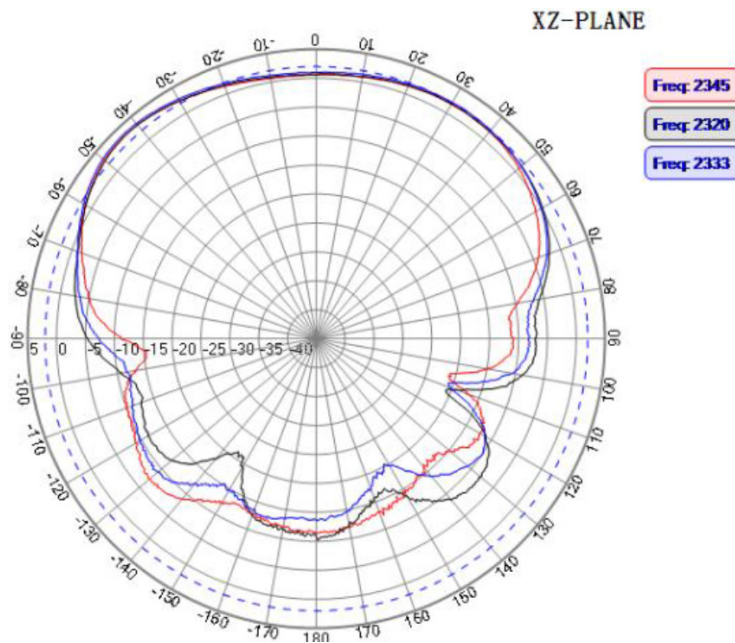
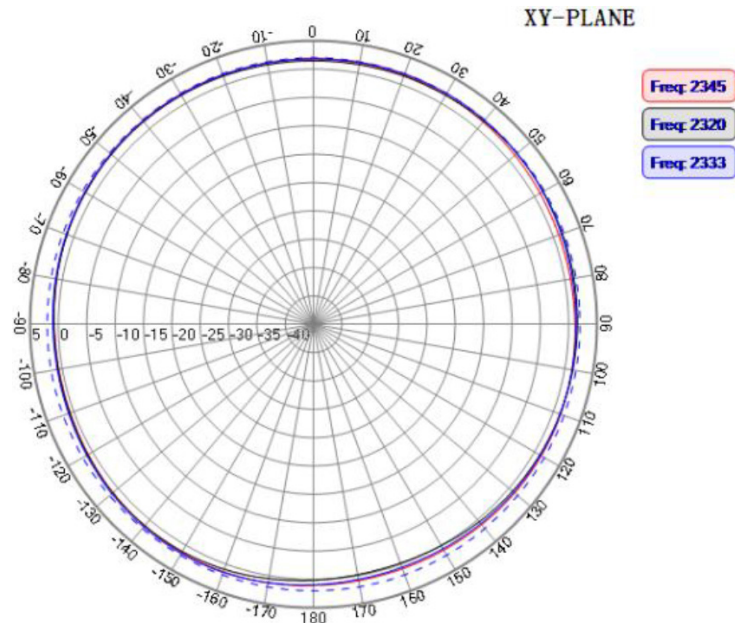

SDARS External Antenna



AEACBD045015-S2332



45.2 x 35.8 x 15.1 mm
RoHS/RoHS II Compliant
MSL = N/A: Not Applicable

Radiation Pattern

2D - Pattern

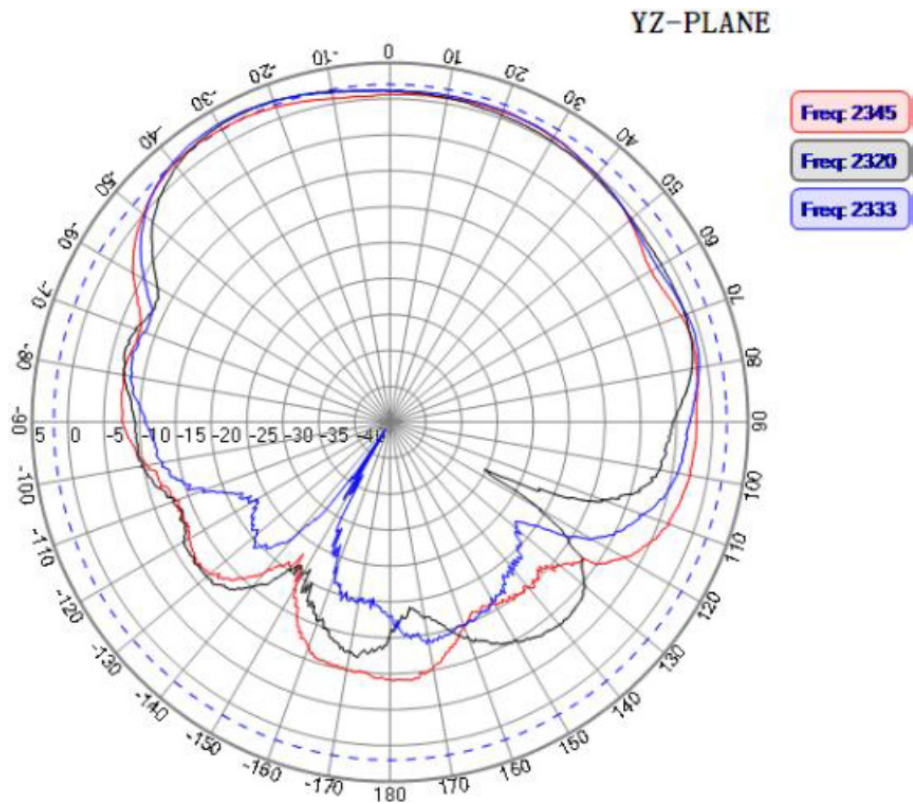

SDARS External Antenna



AEACBD045015-S2332



45.2 x 35.8 x 15.1 mm
RoHS/RoHS II Compliant
MSL = N/A: Not Applicable

Radiation Pattern

3D - Pattern

2320 MHz

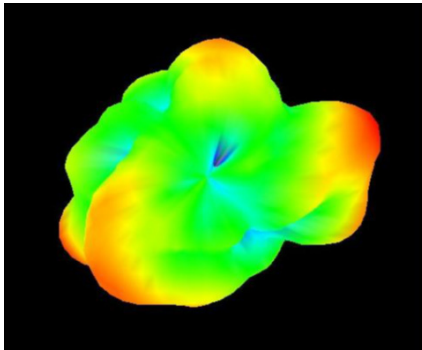

2333 MHz

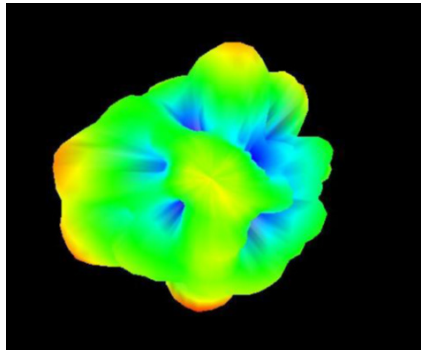

2345 MHz

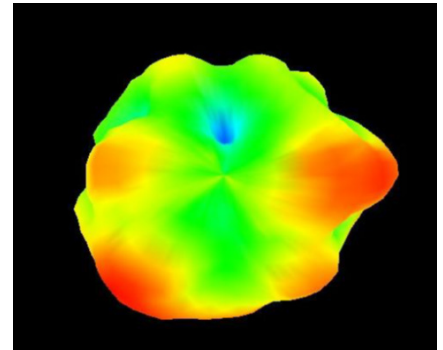

Packaging

A carton holds 200 pcs of antenna. Each carton is of dimension 49 x 23 x 27 cm and weighs 15 Kg.

ATTENTION: Abracon LLC's products are COTS – Commercial-Off-The-Shelf products; suitable for Commercial, Industrial and, where designated, Automotive Applications. Abracon's products are not specifically designed for Military, Aviation, Aerospace, Life-dependent Medical applications or any application requiring high reliability where component failure could result in loss of life and/or property. For applications requiring high reliability and/or presenting an extreme operating environment, written consent and authorization from Abracon LLC is required. Please contact Abracon LLC for more information.



5101 Hidden Creek Ln Spicewood TX 78669
Phone: 512-371-6159 | Fax: 512-351-8858
For terms and conditions of sales, please visit:
www.abracon.com

REVISED: 06-13-19

ABRACON IS
ISO9001-2015
CERTIFIED