

# MAX96705/MAX96711 Evaluation Kit

## Evaluates: MAX96705/MAX96711 with Coax or STP Cable

### General Description

The MAX96705/MAX96711 coax evaluation kit (EV kit) provides a proven design to evaluate the MAX96705 and MAX96711 high-bandwidth gigabit multimedia serial link (GMSL) serializers with spread spectrum and full-duplex control channel, through the use of a standard FAKRA coax or STP cable. The EV kit also includes Windows Vista®- and Windows 7-compatible software that provides a simple graphical user interface (GUI) for exercising features of the device. The EV kit comes with either a MAX96705GTJ+ or MAX96711GTJ+ IC installed.

For complete GMSL evaluation using a standard FAKRA coax cable, order the MAX96705 or MAX96711 EV kit and a companion deserializer board (the MAX96706 or MAX96708 EV kit are referenced in this document). For testing with STP cable, also order the MAXCOAX2STP-HSD adapter kit and refer to its data sheet. Only one adapter kit is required per link (connecting the serializer and deserializer boards).

**Note:** In the following sections, MAX96705/11 and the term “serializer” refer to the MAX96705 or MAX96711 ICs and MAX96706/08 and the term “deserializer” refer to the MAX96706 or MAX96708 ICs.

**Note:** This document applies to both coax and STP EV kits. This document covers coax cables, but the information provided applies equally to STP cables.

[Ordering Information](#) appears at end of data sheet.

### Features

- Accepts 16-Bit Parallel Input Data and Outputs GMSL Serial Data through FAKRA Connectors
- Windows Vista-, and Windows 7-Compatible Software
- USB-Controlled Interface (Cable Included)
- USB Powered
- Proven PCB Layout
- Fully Assembled and Tested

### Items Included in the EV Kit Package

| DESCRIPTION                            | QTY |
|--|-----|
| MAX96705 or MAX96711 coax EV kit board | 1   |
| USB cable                              | 1   |

### MAX96705/MAX96711 EV Kit Files

| FILE                            | DESCRIPTION                                |
|---------------------------------|--|
| MAXSerDesEV-N_Vxxxx_Install.EXE | Installs the EV kit files on your computer |
| MAXSerDesEV-N.EXE               | Graphical user interface (GUI) program     |
| CDM20600.EXE                    | Installs the USB device driver             |
| USB_Driver_Help_200.PDF         | USB driver installation help file          |

*Windows and Windows Vista are registered trademarks and registered service marks of Microsoft Corporation.*



# MAX96705/MAX96711 Evaluation Kit

# Evaluates: MAX96705/MAX96711 with Coax or STP Cable

## Quick Start

### Required Equipment

- MAX96705 or MAX96711 serializer EV kit
- MAX96706 or MAX96708 deserializer EV kit
- 2m FAKRA cable assembly (included with the deserializer EV kit)
- > 20MHz function generator
- PC with Windows Vista or Windows 7 and a spare USB port (direct 500mA connection required; do not use a bus-powered hub)
- 5V DC, 500mA power supply

**Note:** In the following sections, software-related items are identified by bolding. Text in **bold** refers to items from the EV kit software. Text in **bold and underlined** refers to items from the Windows operating system.

### Procedure

The EV kit is fully assembled and tested. Follow the steps below to verify board operation:

- 1) Visit [www.maximintegrated.com/EVkitsoftware](http://www.maximintegrated.com/EVkitsoftware) to download and install the latest version of the EV kit software:
  - Search for MAX9288. Then select **MAX9288 | Design Resources | Software | GMSL SerDes Evaluation Kit Software-Nuvoton**.
  - The installation application will try to download and install the USB driver for the Nuvoton microcontroller. If the USB driver installation was not successful, install the appropriate USB driver for your PC available from the link below, and refer to the USB\_Driver\_Help\_200.PDF file, if needed: [www.ftdichip.com/Drivers/VCP.htm](http://www.ftdichip.com/Drivers/VCP.htm).
- 2) Verify that jumpers on the serializer board are in their default positions, as shown in [Figure 14](#).
- 3) Verify that jumpers on the deserializer board are in their default positions, as shown in [Figure 15](#).
- 4) Set up the system, as shown in [Figure 1](#).
- 5) Connect the FAKRA cable from the OUT+ terminal on the serializer board to the IN0+ terminal on the deserializer board. Both the serializer and deserializer evaluation boards have power-over-coax (POC) circuitry that is active by default, configured such that the deserializer board is the source of the power for the serializer board.
- 6) Connect the USB cable between the PC and USB port on the Nuvoton microcontroller daughter board on the serializer board.
- 7) Verify that LED\_PWR on the deserializer board lights up, indicating that the deserializer board has power.
- 8) Verify that LED\_PWR on the serializer board lights up, indicating that the serializer board has power. Both serializer and deserializer have a power-over-coax (POC) circuit that is active by default.
- 9) Verify that LOCK\_LED on the deserializer board lights up, indicating that the link has been successfully established. If the LOCK\_LED is off, or ERR\_LED is on, go to the [Troubleshooting](#) section and fix the problem before continuing. **Note:** If you are working with an earlier version of the deserializer IC, you must write value of 0xA6 to register address 0x9b at slave address 0x90 to enable the control channel. In the current revision of the IC, this step is no longer needed.
- 10) Start the EV kit software by selecting **Start | Programs | Maxim Integrated | MAXSerDesEV-N | MAXSerDesEV-N**.
- 11) The **Configuration Settings** window opens (see [Figure 2](#)) and the GUI automatically searches for any active listener in both I<sup>2</sup>C and UART mode and identifies a valid GMSL product. Once a valid device is identified, the corresponding configuration jumpers are displayed to help users configure the serializer and deserializer.
- 12) In case an operating evaluation board with a Nuvoton microcontroller is not found, a window appears ([Figure 3](#)) warning as such. Press **OK** to continue and start the GUI anyway, or press **Cancel** to terminate the application. See the [Troubleshooting](#) section at the end of this document and fix the problem before continuing.
- 13) When an operating Nuvoton microcontroller is found, the GUI checks the firmware version in the microcontroller and prompts the user to update ([Figure 4](#)).
- 14) While the **Configuration Settings** window is open, press the **Identify Devices** button to search for the devices connected.
- 15) Only **Link Type** and **Device Address** selections on the **Configuration Settings** window affects the EV kit operation. Other items are for user reference only.
- 16) Press the **Connect** button to open the **Evaluation Kit** window and the devices under test (DUT) register maps ([Figure 5](#)). The GUI will read all internal registers of the serializer and deserializer and update the corresponding tabs.

MAX96705/MAX96711  
Evaluation Kit

Evaluates: MAX96705/MAX96711  
with Coax or STP Cable

- 17) Press the **Read All MAX96705** button in the **Serializer** group box to read all the serializer registers.
- 18) Press the **MAX96705 Des** tab (Figure 6) and then press the **Read All MAX96706** button in the **Deserializer** group box to read all the deserializer registers.
- 19) Select any of the other tabs to evaluate other serializer/deserializer (SerDes) functions.

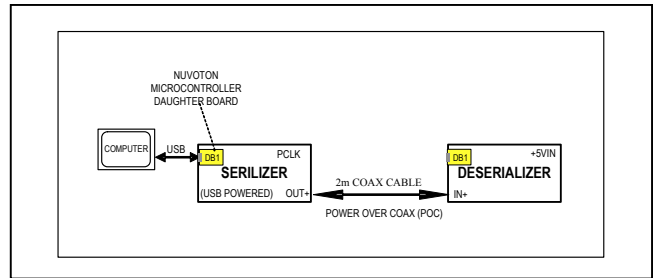

Figure 1. Serializer Test Setup Block Diagram

Table 1. Jumper Description\*

| JUMPER | SIGNAL     | SHUNT POSITION | FUNCTION   |
|--------|------------|----------------|--|
| J1     | +12V       | —              | +12V AC adapter input  |
| J2     | +5VIN      | —              | +5V power-supply input positive terminal   |
| J3     | GND        | —              | +5V power-supply input negative terminal   |
| J4     | OUT+       | —              | GMSL OUT+ FAKRA connector  |
| J5     | OUT-       | —              | GMSL OUT- FAKRA connector  |
| J6     | EXT_UC     | —              | 4-pin header to apply user microcontroller   |
| J11    | U15 ch3    | Open**         | VLC3 = U15 level shifter, channel 3 low side<br>VLC4 = U15 level shifter, channel 4 low side   |
| J13    | U15 ch4    | Open**         | VHC3 = U15 level shifter, channel 3 high side<br>VHC4 = U15 level shifter, channel 4 high side |
| J23    | GPIO5/LMN1 | L              | Connected to GND   |
|        |            | H              | Connected to IOVDD   |
|        |            | Open**         | Not connected  |
| J25    | U4_SCL     | Short**        | μC connected to U4 oscillator  |
|        |            | Open           | μC not connected to U4 oscillator  |
| J26    | IDT_OE     | L              | U4 oscillator output not enabled   |
|        |            | H**            | U4 oscillator output enabled   |
|        |            | Open           | U4 oscillator OE pin not connected   |
| J27    | FSEL0      | L**            | U4 oscillator FSEL0 pin pulled low   |
|        |            | H              | U4 oscillator FSEL0 pin pulled high  |
|        |            | Open           | U4 oscillator FSEL0 pin not connected (internal low)   |
| J28    | FSEL1      | L**            | U4 oscillator FSEL1 pin pulled low   |
|        |            | H              | U4 oscillator FSEL1 pin pulled high  |
|        |            | Open           | U4 oscillator FSEL1 pin not connected (internal low)   |
| J29    | UC_RX/SDA  | RX             | U1 RX/SDA pin connected to μC RX pin   |
|        |            | SDA**          | U1 RX/SDA pin connected to μC SDA pin  |
|        |            | Open           | U1 RX/SDA pin left open  |

**Table 1. Jumper Description\* (continued)**

| JUMPER | SIGNAL     | SHUNT POSITION | FUNCTION   |
|--------|------------|----------------|--|
| J30    | GPIO2      | Short          | Shorted to IOVDD                                   |
|        |            | Open**         | Shorted to GND                                     |
| J32    | GPIO3      | Short          | Shorted to IOVDD                                   |
|        |            | Open**         | Shorted to GND                                     |
| J33    | GPIO4/LMN0 | L              | Connected to GND                                   |
|        |            | H              | Connected to IOVDD                                 |
|        |            | Open**         | Not connected                                      |
| J35    | U4_SDA     | Short**        | μC connected to U4 oscillator                      |
|        |            | Open           | μC not connected to U4 oscillator                  |
| J38    | PCLK_IN    | IDT**          | U1 PCLKIN connected to U4 output                   |
|        |            | SMA            | U1 PCLKIN connected to PCLK_SMA connector          |
|        |            | GND            | GND terminal for externally applied PCLK to J38.1  |
|        |            | Open           | U1 PCLKIN pin not connected                        |
| J39    | UC_TX/SCL  | TX             | U1 TX/SCL pin connected to μC RX pin               |
|        |            | SCL**          | U1 TX/SCL pin connected to μC SDA pin              |
|        |            | Open           | U1 TX/SCL pin left open                            |
| J40    | GPIO1/BWS  | L**            | Connected to GND                                   |
|        |            | H              | Connected to IOVDD                                 |
|        |            | Open           | Not connected                                      |
| J41    | LCCN       | L              | Connected to GND                                   |
|        |            | H**            | Connected to IOVDD                                 |
|        |            | Open           | Not connected                                      |
| J42    | CONF0      | L**            | Connected to GND                                   |
|        |            | H              | Connected to IOVDD                                 |
|        |            | Open           | Not connected                                      |
| J43    | CONF1      | L**            | Connected to GND                                   |
|        |            | H              | Connected to IOVDD                                 |
|        |            | Open           | Not connected                                      |
| J44    | HIM_HI     | Short          | U1 GPO/HIM pin pulled up to IOVDD                  |
|        |            | Open**         | U1 GPO/HIM state depends on J45                    |
| J45    | GPO_LOW    | Short          | U1 GPO/HIM pin connected to IOVDD                  |
|        |            | Open**         | U1 GPO/HIM state depends on J44                    |
| J46    | IOVDD_DUT  | Short**        | U1 GPO/HIM pin connected to IOVDD                  |
|        |            | Open           | Apply ammeter to measure current drawn by U1 IOVDD |

**Table 1. Jumper Description\* (continued)**

| JUMPER | SIGNAL     | SHUNT POSITION | FUNCTION   |
|--------|------------|----------------|--|
| J47    | MS/HVEN    | L              | Connected to GND   |
|        |            | H              | Connected to IOVDD   |
|        |            | Open**         | Not connected  |
| J48    | PWDN       | L              | U1 powered down  |
|        |            | H**            | U1 powered up  |
| J50    | TX/SCL/DBL | DBL-L          | U1 TX/SCL/DBL pin connected to GND   |
|        |            | U15_TC/SCL     | U1 TX/SCL/DBL pin is connected to U15_TX/SCL   |
|        |            | DBL-H          | U1 TX/SCL/DBL pin is connected to IOVDD  |
|        |            | Open           | No POC   |
| J51    | POC+       | POC5VOUT       | 5V POC is sourced by the serializer  |
|        |            | POC5VIN**      | 5V POC is expected from the deserializer   |
|        |            | POC12V         | 12V POC can be applied by either the serializer or deserializer  |
|        |            | Open           | No POC   |
| J52    | POC-       | POC5VOUT       | 5V POC is sourced by the serializer  |
|        |            | POC5VIN**      | 5V POC is expected from the deserializer   |
|        |            | POC12V         | 12V POC can be applied by either the serializer or deserializer  |
|        |            | Open           | No POC   |
| J53    | VDD_REF    | +3.3V**        | Reference voltage for external $\mu$ C signals set to +3.3V  |
|        |            | +5V            | Reference voltage for external $\mu$ C signals set to +5V  |
|        |            | Open           | Reference voltage for external $\mu$ C signals applied to J6.VDD_REF   |
| J54    | EXSDAPU    | Short**        | On-board pullup applied on external $\mu$ C SDA signal   |
|        |            | Open           | External $\mu$ C SDA signal must be pulled up externally   |
| J55    | EXSCLPU    | Short**        | On-board pullup applied on external $\mu$ C SCL signal   |
|        |            | Open           | External $\mu$ C SCL signal must be pulled up externally   |
| J56    | LFR+       | Short**        | Line fault can be monitored by the remote device on the OUT+ terminal (LFAVDD must be short and LFR-, LFL+, LFL- must be open) |
|        |            | Open           | Line fault monitored by local device or OUT- terminal  |
| J57    | LFR-       | Short          | Line fault can be monitored by the remote device on the OUT- terminal (LFAVDD must be short and LFR+, LFL+, LFL- must be open) |
|        |            | Open**         | Line fault monitored by local device or OUT+ terminal  |
| J58    | LFL+       | Short          | Line fault can be monitored by the local device on the OUT+ terminal (LFAVDD must be short and LFR+, LFR-, LFL- must be open)  |
|        |            | Open**         | Line fault monitored by remote device or OUT- terminal   |
| J59    | LFL-       | Short          | Line fault can be monitored by the local device on the OUT- terminal (LFAVDD must be short and LFR+, LFR-, LFL+ must be open)  |
|        |            | Open**         | Line fault monitored by remote device or OUT+ terminal   |

**Table 1. Jumper Description\* (continued)**

| JUMPER | SIGNAL | SHUNT POSITION | FUNCTION   |
|--------|--------|----------------|--|
| J60    | LFAVDD | Short**        | Line-fault circuit powered, connected to AVDD      |
|        |        | Open           | Line fault is powered, nonfunctional               |
| JU2    | IOVDD  | +3.3V**        | U1 IOVDD set to on-board 3.3V                      |
|        |        | EXT            | U1 IOVDD supplied through EXT-IOVDD terminal (J20) |
|        |        | +1.8V          | U1 IOVDD set to on-board 1.8V                      |
| JU3    | DVDD   | INT**          | U1 DVDD supplied from internal source              |
|        |        | EXT            | U1 DVDD supplied through EXT-DVDD terminal (J19)   |
| JU4    | AVDD   | INT**          | U1 AVDD supplied from internal source              |
|        |        | EXT            | U1 AVDD supplied through EXT-AVDD terminal (J18)   |

\*Jumper selections in the **Serializer/Deserializer** group boxes on the **Configurations Settings** window are for reference only and do not affect software operation.

\*\*Default position.

## Detailed Description of Software

To start the serializer evaluation kit GUI, select **Start | All Programs | Maxim Integrated | MAXSerDesEV-N | MAXSerDesEV-N**.

### Configuration Settings Window

The **Configuration Settings** window is the first window that opens after successful program launch. It allows the user to specify serializer and deserializer board setup and mode of operation (Figure 2).

### Controller Group Box

In the **Controller** group box, select **Coax** or **STP** from the **Link Type** drop-down list, **I2C** or **UART** from the **Bus** drop-down list, and whether the **Serializer** or **Deserializer** should be connected to the USB controller. Upon changing any of these parameters, conflicting jumper settings will be highlighted, guiding the user to check and make the corresponding changes to the evaluation boards. Only the **Link Type** and **Device Address** selections on the **Configuration Settings** window affect EV kit operation. Other items, including jumper selection, are for user reference only.

### Serializer and Deserializer Jumper Selection Blocks

The **Serializer** and **Deserializer Jumper Selection** blocks list jumpers on the evaluation boards of the selected Device ID and displays the correct shunt positions based on the conditions selected in the **Controller** block.

### Identify Devices Button

The **Identify Devices** button causes the GUI to scan the system and hunt for slave addresses on the bus. Upon successful communication, it reads the **Device ID** register from the DUTs and displays the corresponding jumper lists on the **Serializer** and **Deserializer Jumper Selection** blocks. It is also possible to select a device from the **Device ID** drop-down list and manually change the slave address in the **Device Address** edit box. It is a good practice to utilize the **Identify Devices** button and verify communication with the DUTs before attempting to **Connect**.

Figure 14 shows jumper settings on the serializer PCB for coax cable and I<sup>2</sup>C communication with a USB cable connected to the serializer board. Refer to the respective SerDes IC data sheets for detailed configuration information. See Table 1 for the serializer jumper descriptions.

### Connect Button

The **Connect** button opens the **Evaluation Kit** window. The GUI reads the SerDes registers and updates the register maps for both. Successful register map updates are indicated by green LED indicators. In case of a communication problem, the LED indicators turn red.

### Cancel - Do not Connect Button

The **Cancel- Do Not Connect** button opens the **Evaluation Kit** main window without attempting to connect to the microcontroller. Although there is no communication with the microcontroller, all functions and tabs corresponding to the selected **Device IDs** on the **Evaluation Kit** window become active once there.

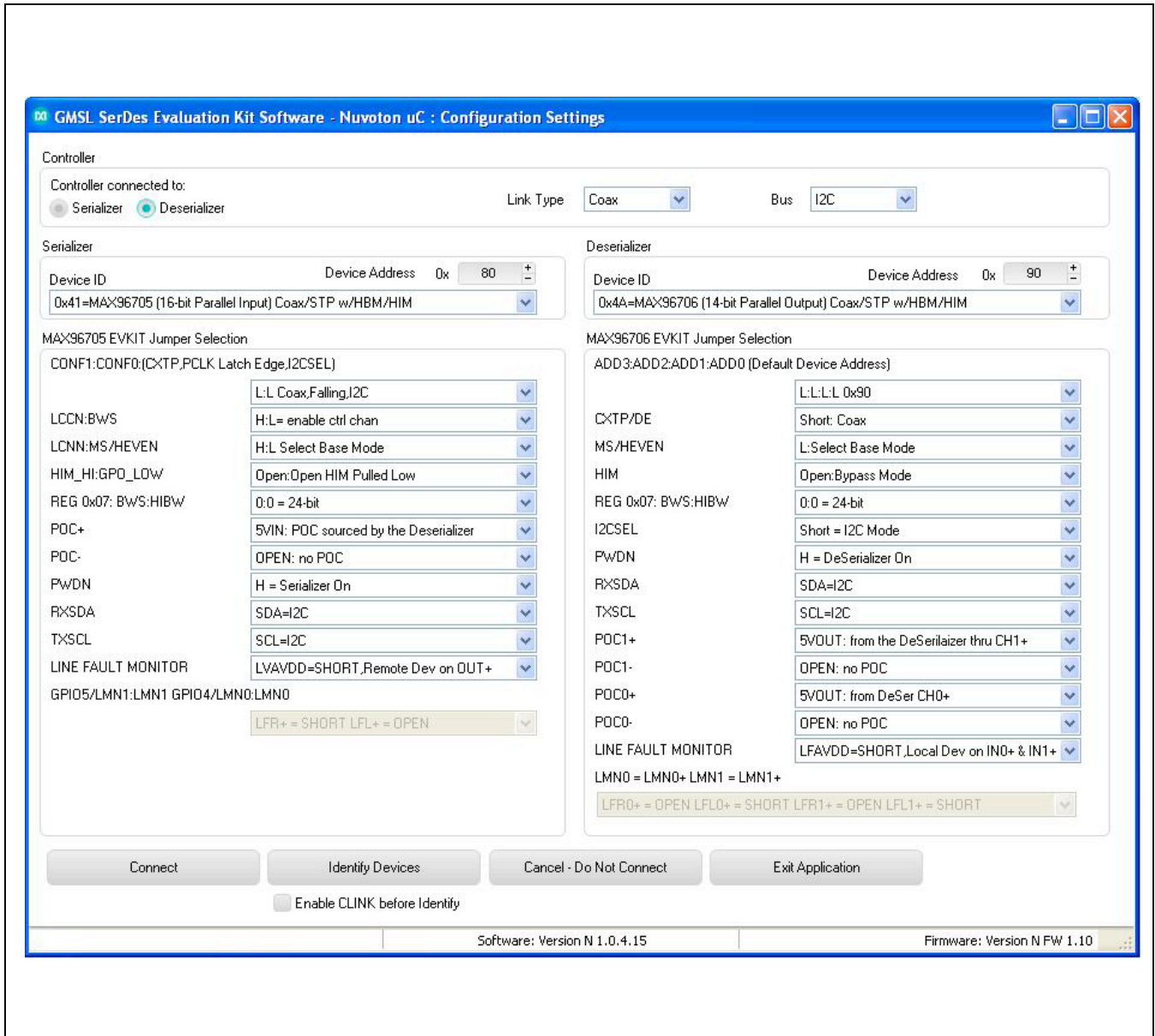

Figure 2. MAXSerDesEV-N EV Kit Software: Configuration Settings Window (shown with MAX96705 and MAX96706 EV Kits Connected)

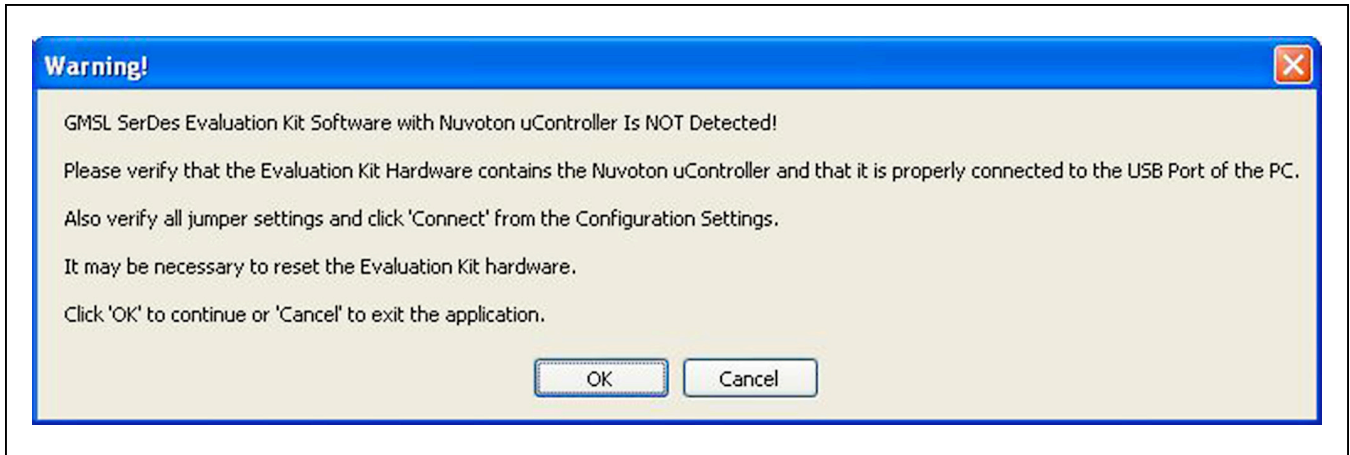

Figure 3. MAXSerDesEV-N EV Kit Software: Warning! (Nuvoton  $\mu$ Controller is NOT Detected!)

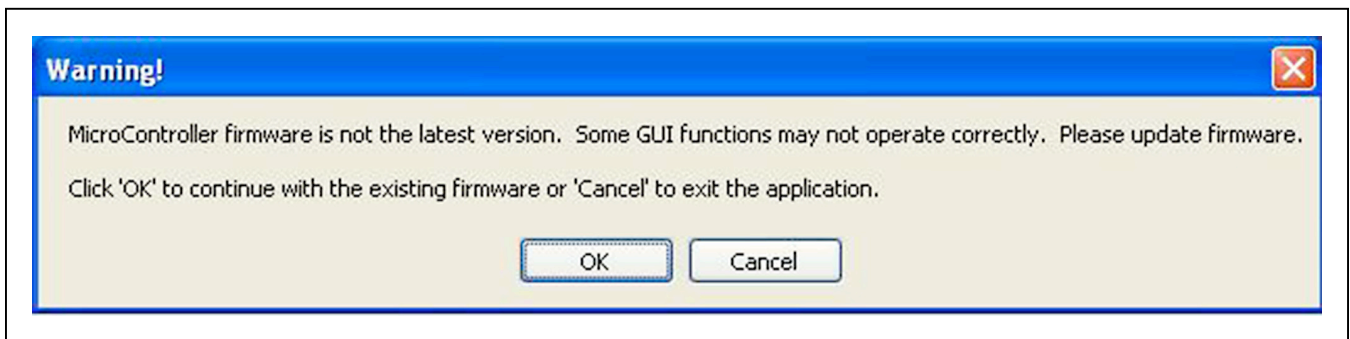

Figure 4. MAXSerDesEV-N EV Kit Software: Warning! (Microcontroller Firmware is Not the Latest Version)

### Evaluation Kit Window

The **Evaluation Kit** window shown in [Figure 5](#) provides access to all internal registers and functions of the DUTs by means of reading and writing registers through different tabs, thus enabling the user to evaluate various functions of the serializer and deserializer.

The **Read All** button updates the SerDes register maps by reading the DUT's internal registers.

The **Serializer** group box provides pushbuttons to update the serializer's register map from the DUT using the **Read All MAX96705** button. The **Load** button reads and

updates from a previously saved file and the **Save** button saves the existing register values into a new file.

The **Deserializer** group box provides pushbuttons to update the deserializer's register map from the DUT using the **Read All MAX96706** button. The **Load** button reads and updates from a previously saved file and the **Save** button saves the existing register values into a new file.

The **Wake Up** button applies the register write sequence described in the IC data sheets to wake the DUTs from sleep mode.

The **Open Configuration** button returns to the **Configuration Settings** window.



**MAX96705 Ser Tab**

The **MAX96705 Ser** tab (Figure 5) lists the serializer's register bitmaps. The **Read** and **Write** buttons in each register group box allows access to each bit or group of bits that specify a function or condition, as defined in the respective serializer IC data sheet. The color of the small LED indicator next to the **Read/Write** buttons indicates the communication status. Green indicates successful communication and red indicates failed communication.

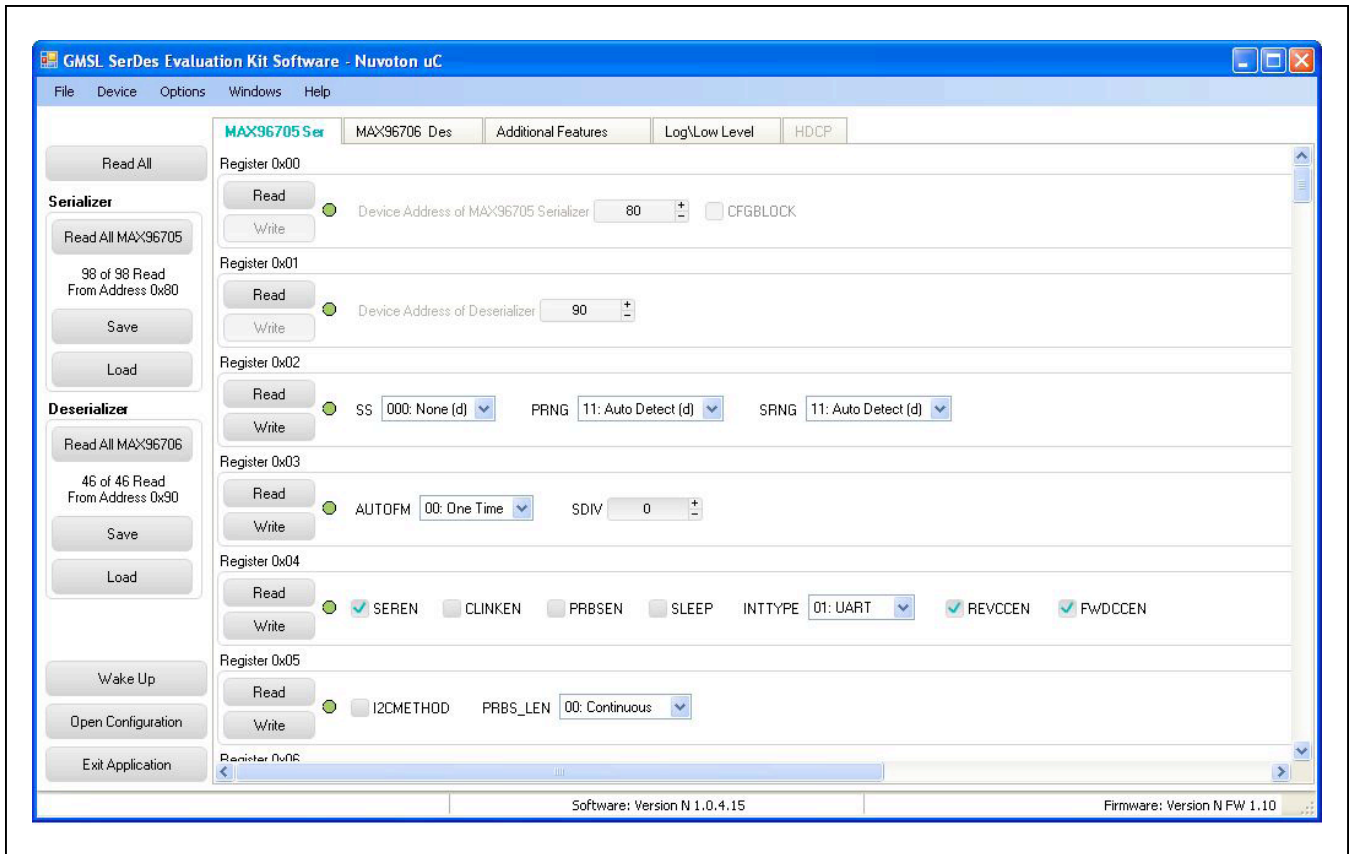

Figure 5. MAXSerDesEV-N EV Kit Software: Evaluation Kit Window (MAX96705 Ser Tab (Serializer))

### MAX96706 Des Tab

The **MAX92706 Des tab** (Figure 6) lists the deserializer's register bitmaps. The **Read** and **Write** buttons in each register group box allows access to each bit or group of bits that specify a function or condition, as defined in the respective dserializer data sheet. The color of the small LED indicator next to the **Read/Write** buttons indicates the communication status. Green indicates successful communication and red indicates failed communication.

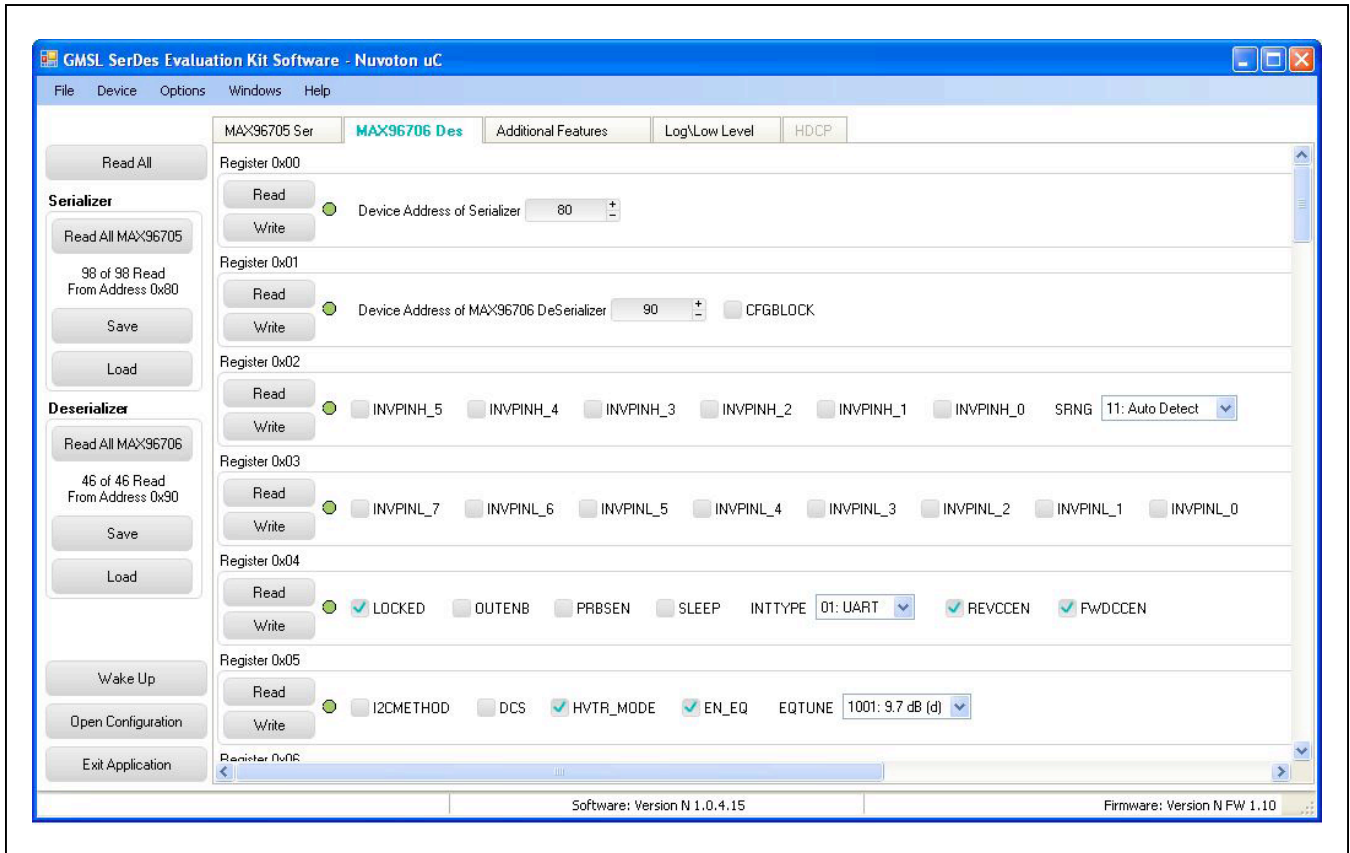

Figure 6. MAXSerDesEV-N EV Kit Software: Evaluation Kit Window (MAX96706 Des Tab (Deserializer))

### Additional Features Tab

The **Additional Features** tab (Figure 7) provides pushbuttons for specific functions that connected devices can perform. By pressing a button, a new window pops up, launching the specific function selected. Function buttons not supported by the selected device are grayed out.

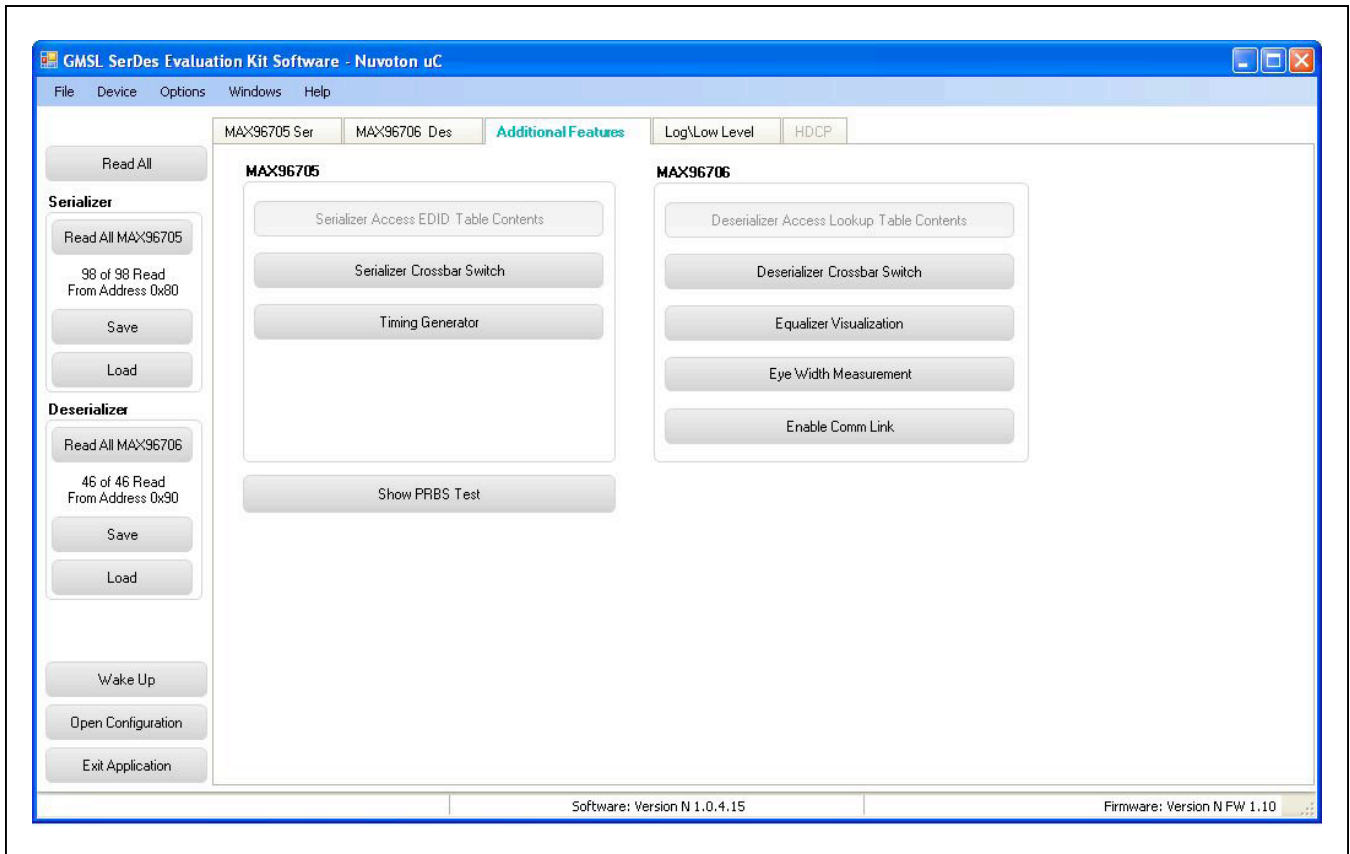

Figure 7. MAXSerDesEV-N EV Kit Software: Evaluation Kit Window (Additional Features Tab)

On the **Additional Features** tab, press the **Serializer Crossbar Switch** button to launch the **Serializer Crossbar Switch Configuration** function (Figure 8). This capability allows the rerouting of data between the parallel input/output by the serializer. Refer to the respective IC data sheet for a detailed description and operation on the embedded crossbar switches.

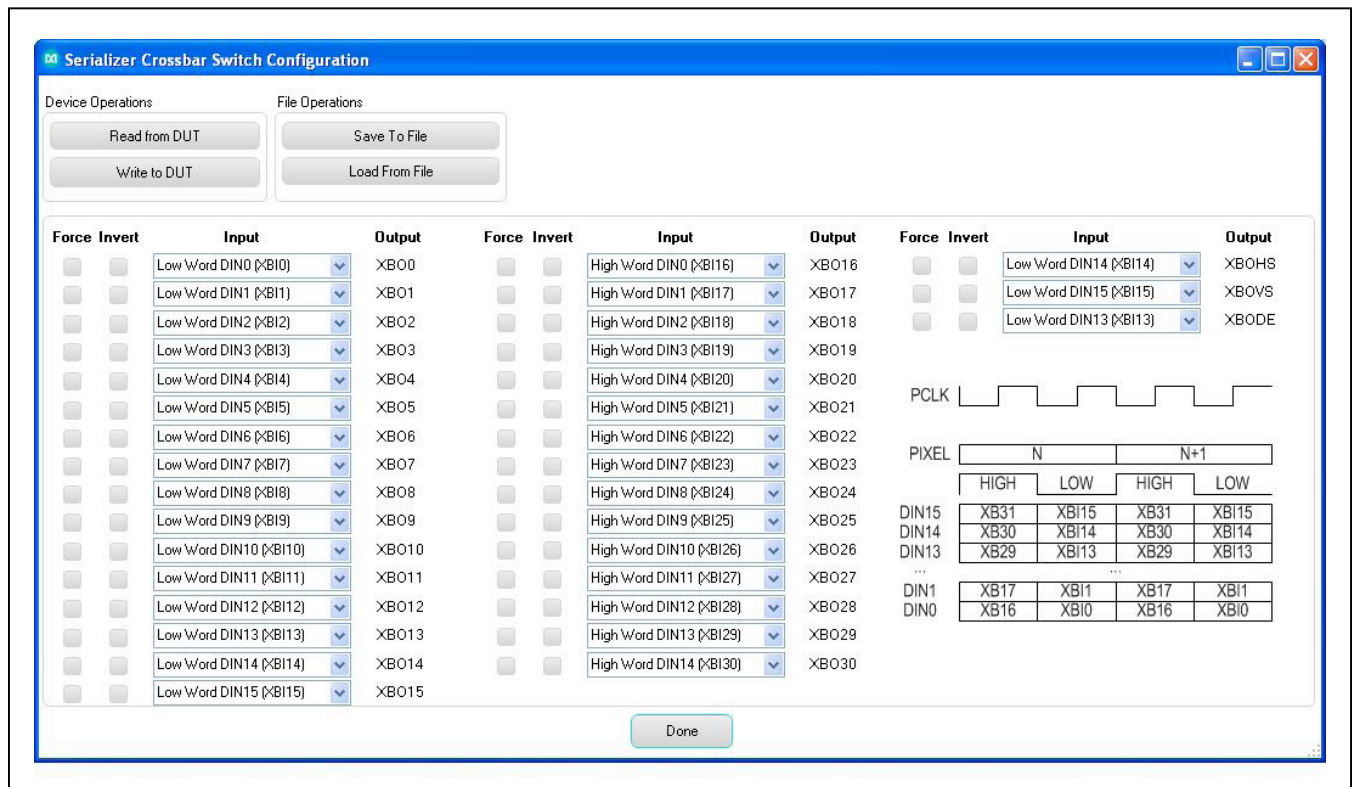

Figure 8. MAXSerDesEV-N EV Kit Software: Evaluation Kit Window (Serializer Crossbar Switch Configuration Window)

On the **Additional Features** tab, press the **Deserializer Crossbar Switch** button to launch the **Deserializer Crossbar Switch Configuration** function for the deserializer (Figure 9). This capability enables rerouting data between the parallel input/output by the deserializer. Refer to the respective IC data sheet for a detailed description and operation on the embedded crossbar switches.

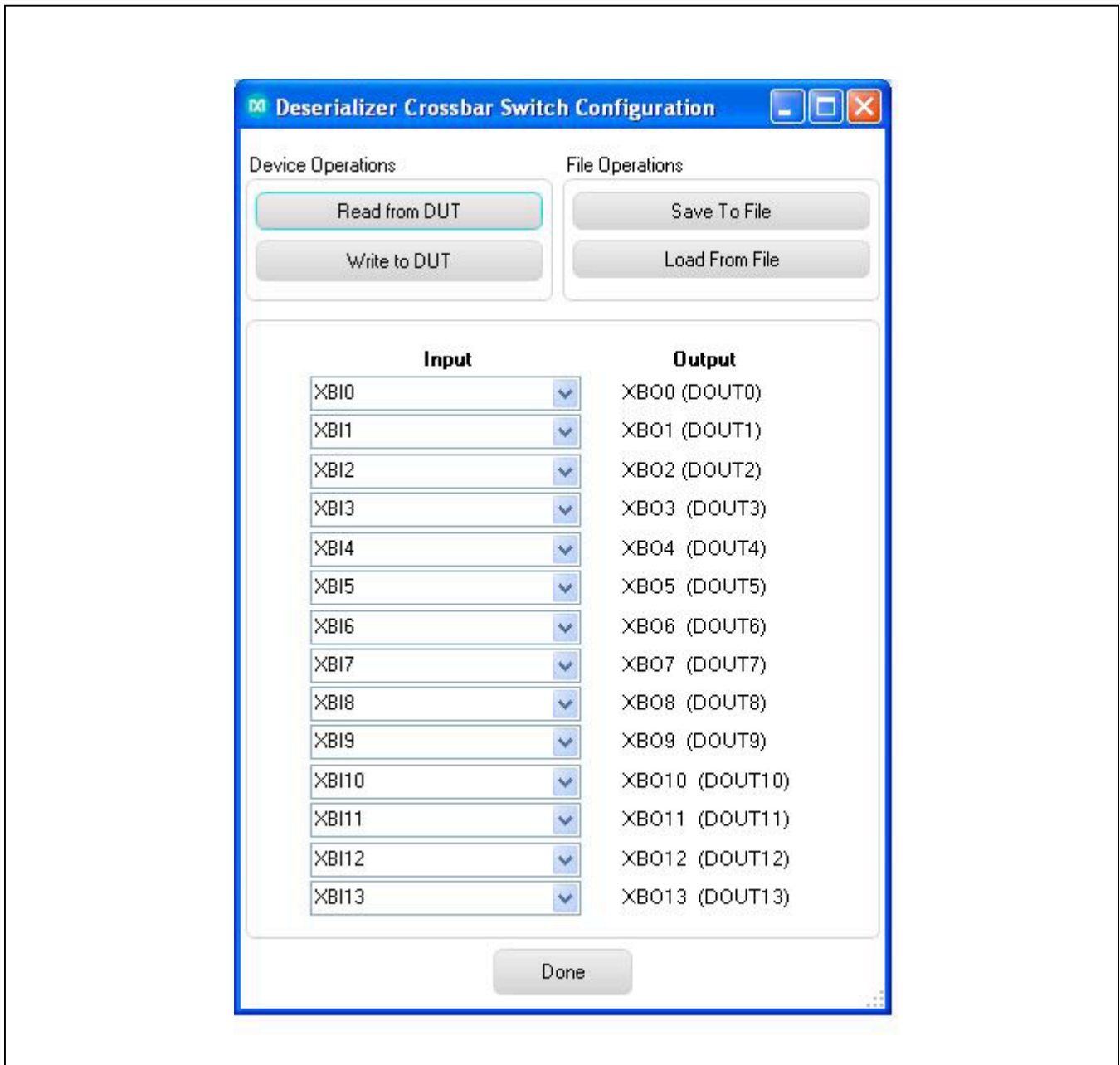

Figure 9. MAXSerDesEV-N EV Kit Software: Evaluation Kit Window (Deserializer Crossbar Switch Configuration Window)

On the **Additional Features** tab, press the **Timing Generator** button to launch this function (Figure 10), which allows the user to utilize the programmable video timing generator to generate/retime the input sync signals. Refer to the respective IC data sheet for a detailed description.

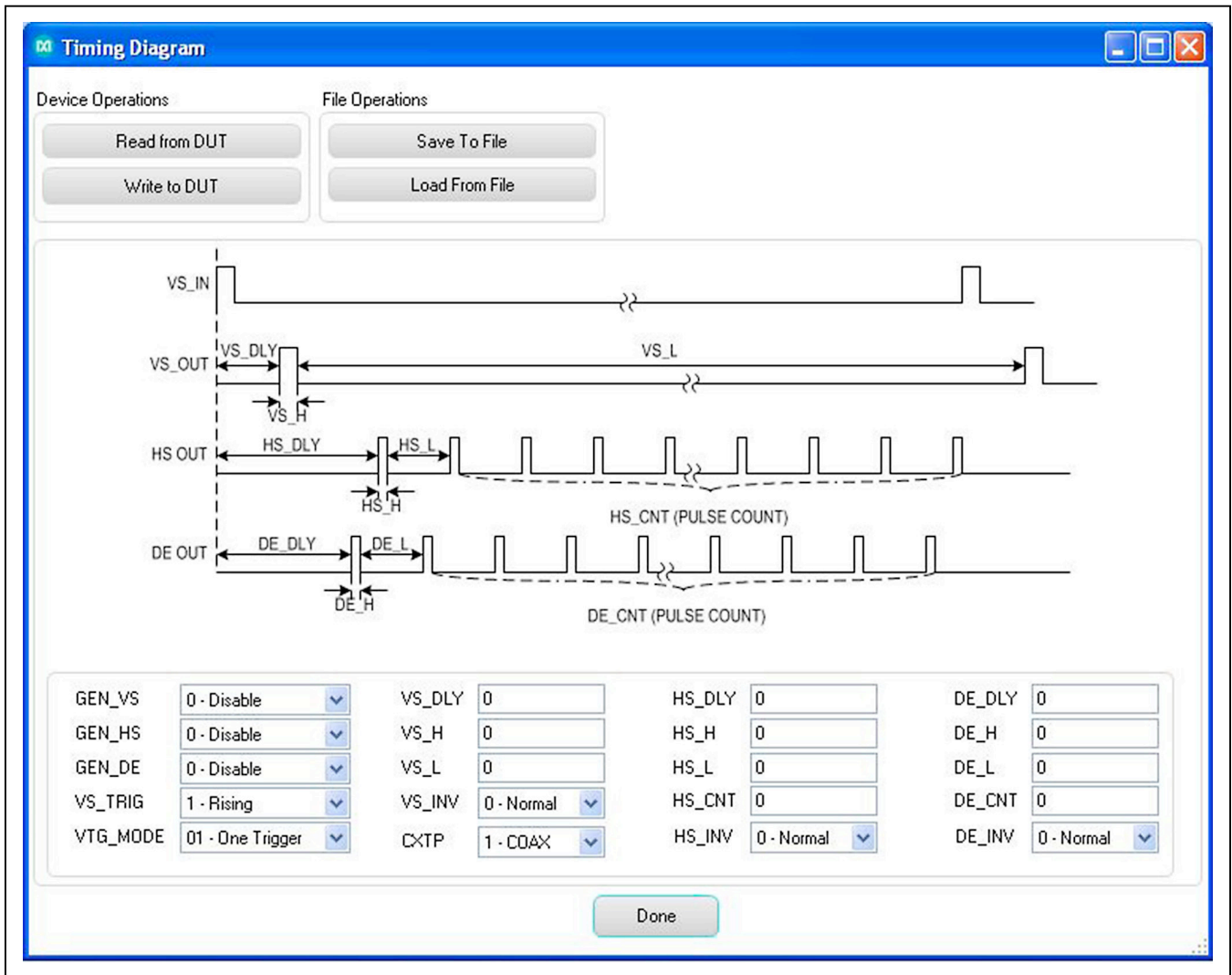

Figure 10. MAXSerDesEV-N EV Kit Software: Evaluation Kit Window (Timing Generator Window)

On the **Additional Features** tab, press the **Equalizer Visualization** button to launch this function (Figure 11), which allows compensating for higher cable attenuation and higher frequencies. Refer to the respective IC data sheet for a detailed description.

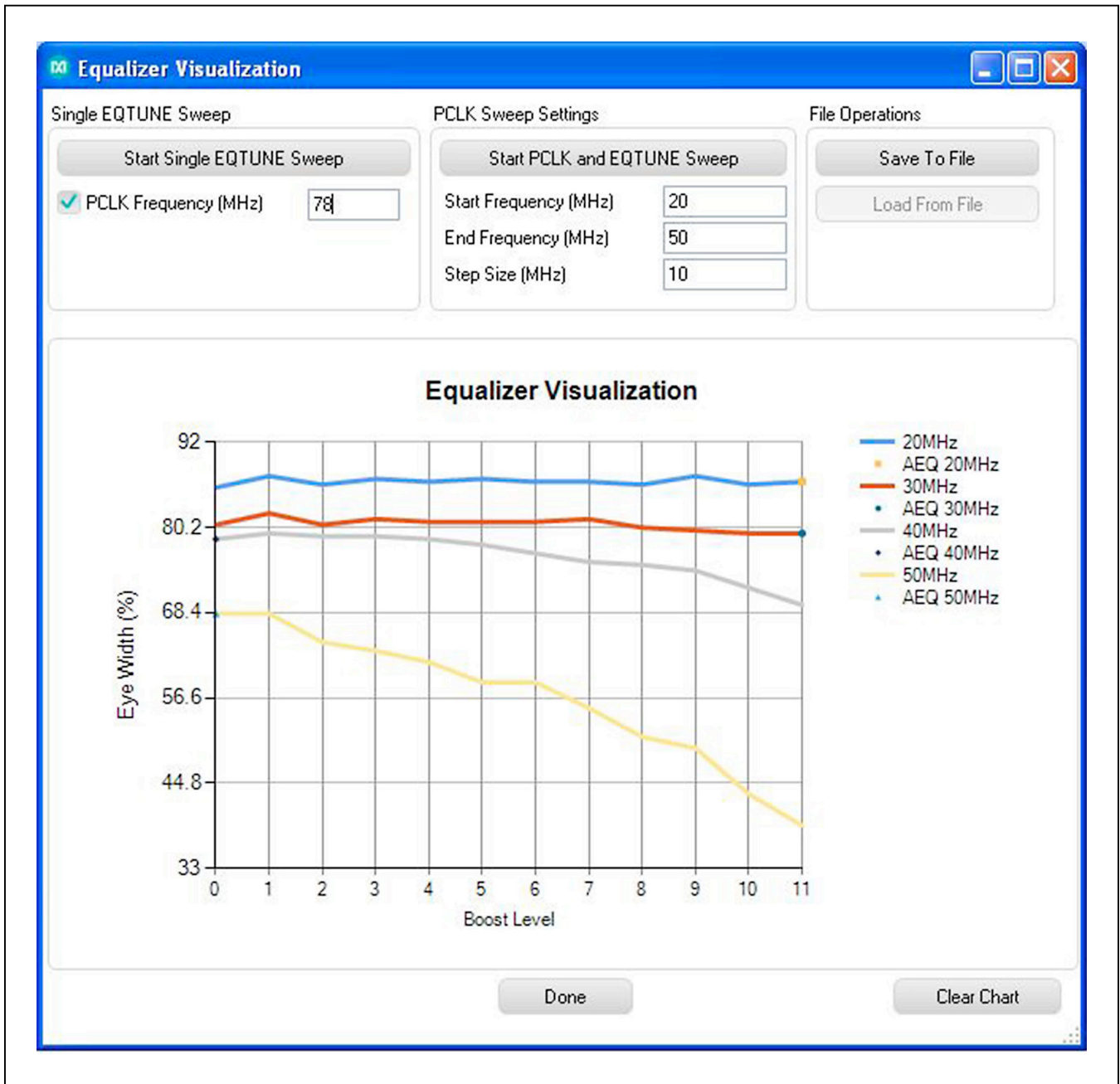

Figure 11. MAXSerDesEV-N EV Kit Software: Evaluation Kit Window (Equalizer Visualization Window)

On the **Additional Features** tab, press the **Show PRBS Test** button to perform a PRBS test (Figure 12). Enter test duration (maximum 32,767s = 9.1hrs) in the **Duration** edit box and press **Start** to start the test. At test completion, the number of bit errors are read from the PRBSERR register, and displayed in the **PRBS Error Counter** box.

### Log\Low Level Tab

The **Log\Low Level** tab (Figure 13) logs all activities between the GUI and DUTs.

The **Register Access** group box allows reads or writes of the specified slave and register addresses. Use the **Send String to EVKIT** button to communicate with non-register-based devices (such as the MAX7324). The **SerDes Baud Rate** drop-down list sets the communications baud rate. Note that the baud rate should be changed in small increments/decrements (one step change is forced by the GUI).

### Detailed Description of Firmware

The Nuvoton microcontroller on the daughter board runs a custom firmware that ensures reliable communication between the PC and DUTs. The firmware records 9-bit even-parity data received from the USB interface while RTS is set, and plays back the 9-bit data with 1.5 stop bits timing when RTS is cleared. Data received from the DUTs is immediately relayed to the USB port.

### Detailed Description of Hardware

The MAX96705/MAX96711 coax EV kit provides a proven design and layout for the MAX96705 and MAX96711 GMSL serializers, which was designed to be reliable with ease of use, flexibility, parallel input, and FAKRA coaxial cable serialized output. On-board level translators and easy-to-use USB-PC connections are included on the EV kit.

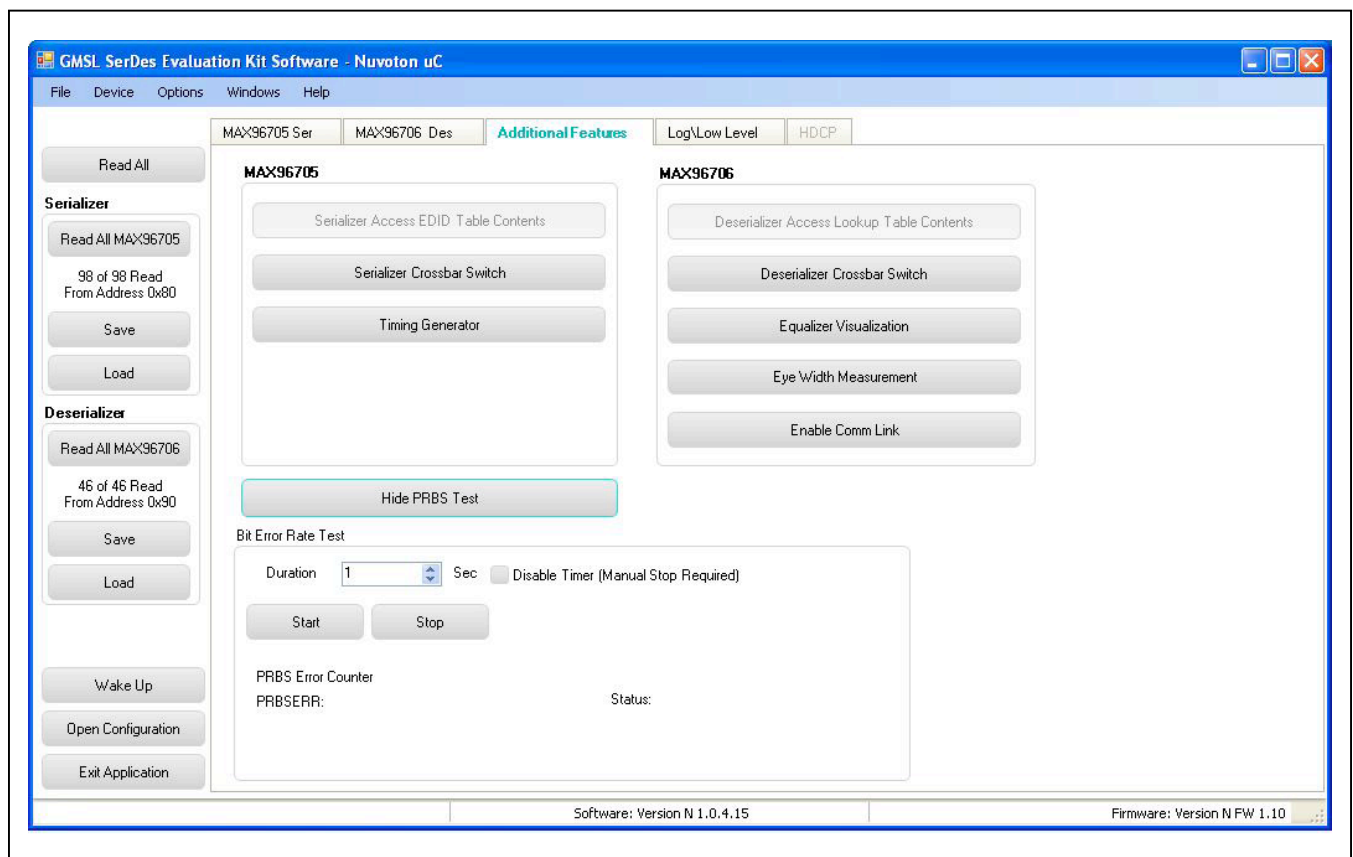

Figure 12. MAXSerDesEV-N EV Kit Software: Evaluation Kit Window (Show PRBS Test Window, Expanded)



# MAX96705/MAX96711 Evaluation Kit

Evaluates: MAX96705/MAX96711  
with Coax or STP Cable

The MAX96705/MAX96711 coax EV kit board consists of four principal functional blocks:

- 1) Microcontroller daughter board
- 2) MAX96705/MAX96711 application circuit block
- 3) Power-supply block
- 4) Oscillator (PCLK) circuit block

## Microcontroller Daughter Board

The Nuvoton-based microcontroller daughter board provides UART and I<sup>2</sup>C interfaces that communicate with both serializer and deserializer boards when they are powered on and properly configured. The Nuvoton microcontroller is programmed with the latest firmware at the time of manufacturing.

To use the EV kit with an externally applied controller, remove the Nuvoton microcontroller board from the EV kit board (DB1 position) and apply the RX/SDA, TX/SCL, VDD, and GND signals from the user microcontroller to the corresponding signals on J6 of the serializer board. Use one of the logic levels from the VDD\_REF, J53 header, or apply externally.

## Application Circuit

The application circuit block includes the serializer and all other components and circuits suggested in the respective IC data sheet, and test points and provisions to provide access to internal functions of the serializer for evaluation of the product.

## Power Supplies

On-board LDO regulators U2, U3, and U12 generate various voltage levels required to operate the EV kit board. There are four options to power the board:

- 1) USB port (default)
- 2) 12V AC adapter
- 3) 5V power supply applied power over coax cable
- 4) Power jumper (JU1 selects from the four power sources)

To operate the EV kits with voltage levels different from what are generated by on-board regulators, move desired IOVDD (JU2), DVDD (JU3), and AVDD (JU4) shunt from INT to EXT positions and apply the external voltage to the corresponding wire-loop terminal.

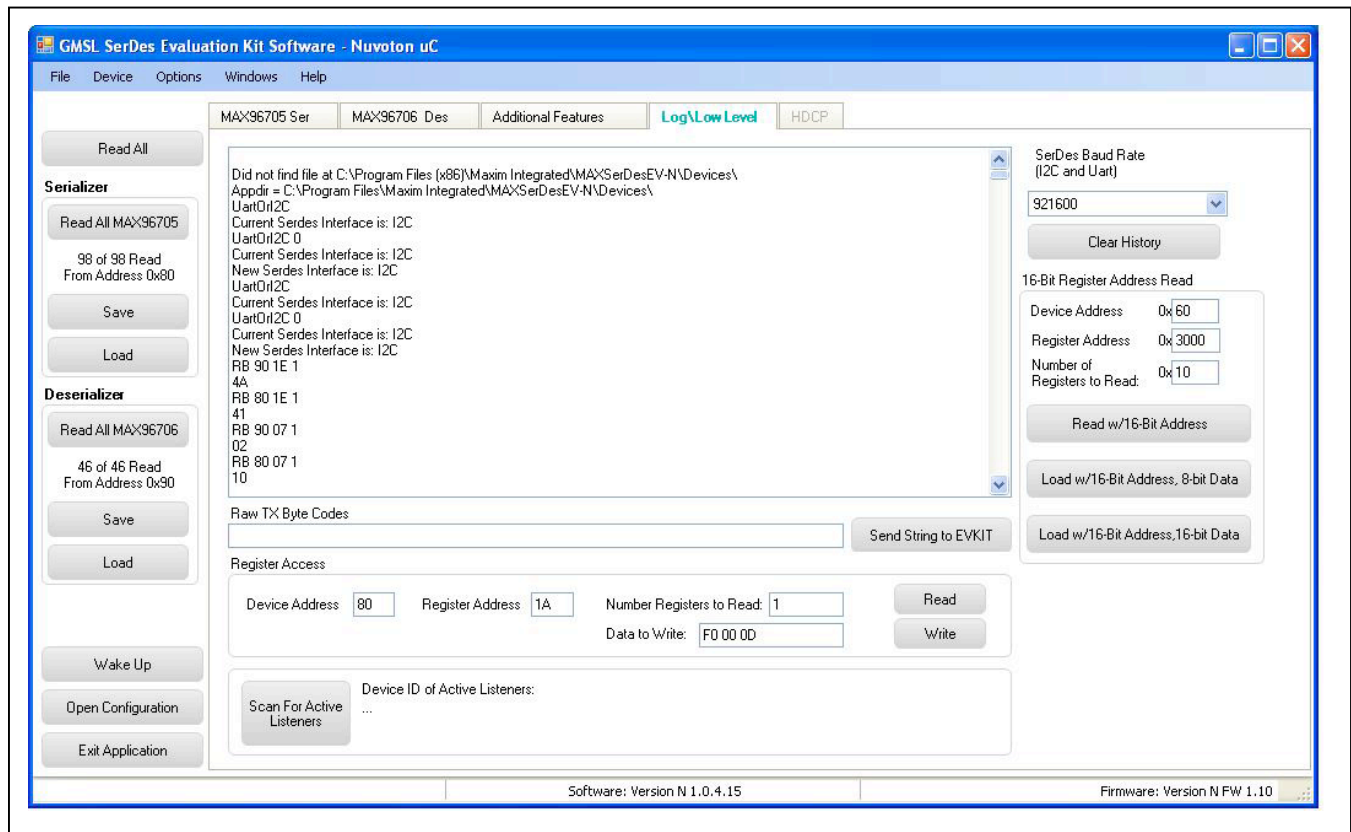

Figure 13. MAXSerDesEV-N EV Kit Software: Evaluation Kit Window (Log/Low Level Tab)

# MAX96705/MAX96711 Evaluation Kit

Evaluates: MAX96705/MAX96711  
with Coax or STP Cable

## Oscillator (PCLK) Circuit Block

An on-board custom oscillator (U4) to supply PCLK is provided to facilitate the serializer/deserializer evaluation. This is an I<sup>2</sup>C-programmable oscillator with four custom preprogrammed and jumper-selectable frequencies. FSEL0 and FSEL1 jumper positions select one of the preprogrammed frequencies per list below:

### FSEL1 FSEL0 PCLK (MHz)

|   |   |       |
|---|---|-------|
| L | L | 25.0  |
| L | H | 37.0  |
| H | L | 78.0  |
| H | H | 104.0 |

Place jumper IDT\_EN (J26) in the “L” position to disable the oscillator output. To operate the the oscillator at a frequency other than the four preprogrammed frequencies, refer to the oscillator data sheet available at [www.idt.com/products/clocks-timing/quartz-crystal-oscillator-ics-xo-crystal-clock-oscillators-and-low-power-oscillator-circuits/8n0q001-quad-frequency-programmable-xo-0](http://www.idt.com/products/clocks-timing/quartz-crystal-oscillator-ics-xo-crystal-clock-oscillators-and-low-power-oscillator-circuits/8n0q001-quad-frequency-programmable-xo-0), or contact the manufacturer.

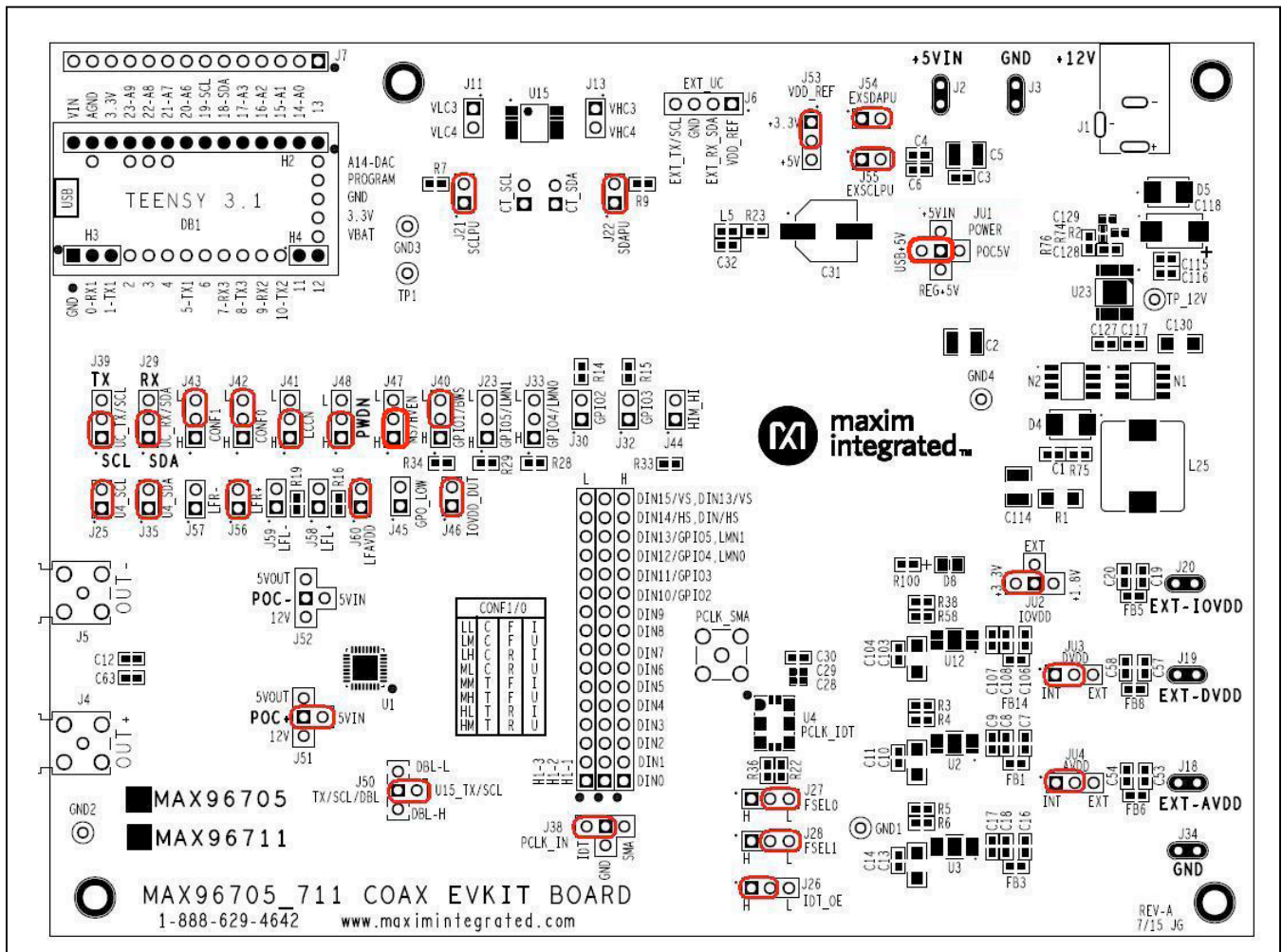

Figure 14. MAX96705/MAX96711 Coax EV Kit Jumper Settings for Coax Link and I<sup>2</sup>C Communication

MAX96705/MAX96711  
Evaluation Kit

Evaluates: MAX96705/MAX96711  
with Coax or STP Cable

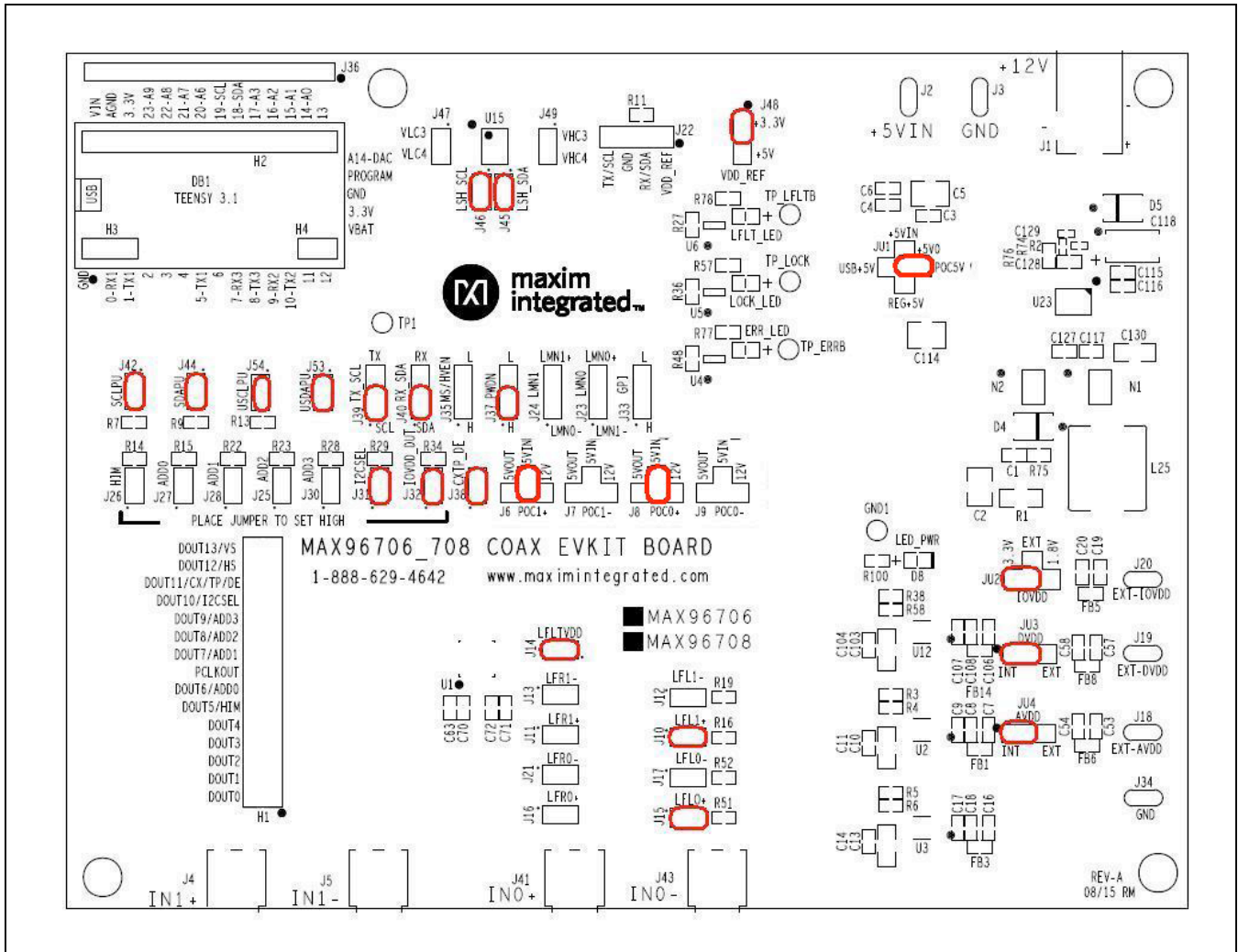

Figure 15. MAX96706/MAX96708 Coax EV Kit Jumper Settings for Coax Link and I2C Communication

**Troubleshooting**

Possible causes of board test failure:

- 1) Coax cable not properly connected between the serializer OUT+ to the deserializer IN+.
- 2) PCLKIN not applied (e.g., FG output is disabled): Verify signal at the pins on the board.
- 3) PCLKIN and function generator output are not correct: Verify signal at the pins on the board.
- 4) Incorrect jumper setting on the deserializer board: Reverify.
- 5) Incorrect jumper setting on the serializer board: Reverify.
- 6) Bus selection on the GUI is not consistent with jumpers' position on the boards: Check and verify that USB cable is properly connected.
- 7) USB port has locked: Exit application GUI, remove USB cable from the board, reinsert and relaunch the GUI.
- 8) Nuvoton μC is not communicating: Exit application GUI, remove USB cable from the board, reinsert and relaunch the GUI.
- 9) Deserializer board is faulty: Try a different board (if available).
- 10) Serializer board is faulty: Try a different board (if available).

# MAX96705/MAX96711 Evaluation Kit

Evaluates: MAX96705/MAX96711  
with Coax or STP Cable

## Component Suppliers

| SUPPLIER                             | PHONE             | WEBSITE                 |
|--------------------------------------|-------------------|-------------------------|
| Amphenol RF                          | 800-627-7100      | www.amphenolrf.com      |
| Hong Kong X'tals Ltd.                | 852-35112388      | www.hongkongcrystal.com |
| Integrated Device Technology (IDT)   | 908-766-4941      | www.idt.com             |
| Murata Americas                      | 770-436-1300      | www.murataamericas.com  |
| ON Semiconductor                     | 602-244-6600      | www.onsemi.com          |
| Rosenberger Hochfrequenztechnik GmbH | 011-49-86 84-18-0 | www.rosenberger.de      |
| TDK Corp.                            | 847-803-6100      | www.component.tdk.com   |

**Note:** Indicate that you are using the MAX96705 or MAX96711 when contacting these component suppliers.

## Component List

Click on the links below for component information, schematics, and PCB layout diagrams:

- [MAX96705/MAX96711 EV Kit BOM](#)
- [MAX96705/MAX96711 EV Kit Schematics](#)
- [MAX96705/MAX96711 EV Kit PCB Layout](#)

## Ordering Information

| PART                | TYPE        |
|---------------------|-------------|
| MAX96705COAXEVKIT#  | EV Kit      |
| MAX96711COAXEVKIT#* | EV Kit      |
| MAXCOAX2STP-HSD#    | Adapter Kit |

#Denotes RoHs compliant.

\*Future product—contact factory for availability.

**Note:** The MAX96705 and MAX96711 coax EV kits are normally ordered with a companion board:

- MAX96706 coax EV kit (MAX96706COAXEVKIT#)
- MAX96708 coax EV kit (MAX96708COAXEVKIT#)\*

MAX96705/MAX96711  
Evaluation Kit

Evaluates: MAX96705/MAX96711  
with Coax or STP Cable

## Revision History

| REVISION NUMBER | REVISION DATE | DESCRIPTION     | PAGES CHANGED |
|-----------------|---------------|-----------------|---------------|
| 0               | 12/15         | Initial release | —             |

For pricing, delivery, and ordering information, please contact Maxim Direct at 1-888-629-4642, or visit Maxim Integrated's website at [www.maximintegrated.com](http://www.maximintegrated.com).

*Maxim Integrated cannot assume responsibility for use of any circuitry other than circuitry entirely embodied in a Maxim Integrated product. No circuit patent licenses are implied. Maxim Integrated reserves the right to change the circuitry and specifications without notice at any time.*

TITLE: Bill of Materials

DATE: 12/2015

DESIGN: max96705\_711\_evkit\_a

**NOTE:** DNI = DO NOT INSTALL ; DNP = DO NOT PROCURE

| REF_DES  | DNI/DNP | QTY | VALUE  | DESCRIPTION   | MFG PART #  | MANUFACTURER   |
|--|---------|-----|--------|---|---|--|
| C1   | -       | 1   | 1500PF | CAPACITOR; SMT (0603); CERAMIC CHIP; 1500PF; 50V; TOL=10%; MODEL=C SERIES; HIGH TEMPERATURE; TG=-55 DEGC TO +150 DEGC; TC=X8R | C1608X8R1H152K080   | TDK  |
| C2   | -       | 1   | 10UF   | CAPACITOR; SMT (1210); CERAMIC CHIP; 10UF; 16V; TOL=20%; MODEL=; TG=-55 DEGC TO +125 DEGC; TC=X7R                             | C1210C106M4RAC;<br>C3225X7R1C106M200AB  | KEMET/TDK  |
| C3, C8, C18, C30, C32, C108, C115, C127          | -       | 8   | 10UF   | CAPACITOR; SMT (0603); CERAMIC CHIP; 10UF; 16V; TOL=20%; TG=-25 DEGC TO +85 DEGC; TC=JB                                       | C1608JB1C106M080AB  | TDK  |
| C4, C6, C7, C9, C16, C17, C106, C107, C116, C117 | -       | 10  | 0.1UF  | CAPACITOR; SMT (0603); CERAMIC CHIP; 0.1UF; 25V; TOL=10%; MODEL=C SERIES; TG=-55 DEGC TO +125 DEGC; TC=X7R                    | C1608X7R1E104K080AA   | TDK  |
| C5, C34, C64, C114                               | -       | 4   | 100UF  | CAPACITOR; SMT (1210); CERAMIC CHIP; 100UF; 10V; TOL=20%; MODEL=CL SERIES; TG=-55 DEGC TO +85 DEGC; TC=X5R                    | CL32A107MPVNNN  | SAMSUNG ELECTRONICS  |
| C10, C13, C103, C130                             | -       | 4   | 10UF   | CAPACITOR; SMT (1206); CERAMIC CHIP; 10UF; 10V; TOL=20%; MODEL=C SERIES; TG=-55 DEGC TO +85 DEGC; TC=X5R                      | C3216X5R1A106M160   | TDK  |
| C11, C14, C19, C20, C53, C54, C57, C58, C104     | -       | 9   | 4.7UF  | CAPACITOR; SMT (0603); CERAMIC; 4.7UF; 6.3V; TOL=20%; MODEL=C SERIES; TG=-55 DEGC TO +85 DEGC; TC=X5R                         | C1608X5R0J475M080AB;<br>GRM188R60J475ME19;<br>JMK107BJ475MA-T   | TDK/MURATA/TAIYO YUDEN   |
| C12, C33, C62, C63                               | -       | 4   | 0.22UF | CAPACITOR; SMT (0603); CERAMIC CHIP; 0.22UF; 50V; TOL=10%; MODEL=C SERIES; TG=-55 DEGC TO +125 DEGC; TC=X7R                   | C1608X7R1H224K080   | TDK  |
| C15, C21, C22, C27, C28, C35, C61                | -       | 7   | 0.1UF  | CAPACITOR; SMT (0402); CERAMIC CHIP; 0.1UF; 16V; TOL=10%; TG=-55 DEGC TO +125 DEGC; TC=X7R;                                   | C0402X7R160-104KNE;<br>CL05B104KO5NNNC;<br>GRM155R71C104KA88;<br>C1005X7R1C104K;<br>CC0402KRX7R7BB104;<br>EMK105B7104KV | VENKEL LTD./SAMSUNG<br>ELECTRONICS/MURATA/TDK/YAGEO<br>PHICOMP/TAIYO YUDEN |

| REF_DES                               | DNI/DNP | QTY | VALUE          | DESCRIPTION  | MFG PART #          | MANUFACTURER              |
|---------------------------------------|---------|-----|----------------|--|---------------------|---------------------------|
| C23-C26, C36, C60, C97                | -       | 7   | 1000PF         | CAPACITOR; SMT (0402); CERAMIC CHIP; 1000PF; 50V; TOL=10%; MODEL=C SERIES; TG=-55 DEGC TO +125 DEGC; TC=X7R      | C1005X7R1H102K050BA | TDK                       |
| C29, C85, C96, C99, C100              | -       | 5   | 0.1UF          | CAPACITOR; SMT (0402); CERAMIC; 0.1UF; 16V; TOL=10%; MODEL=GRM SERIES; TG=-55 DEGC to +85 DEGC; TC=X5R           | GRM155R61C104KA88   | MURATA                    |
| C31                                   | -       | 1   | 470UF          | CAPACITOR; SMT (CASE_F); ALUMINUM-ELECTROLYTIC; 470UF; 16V; TOL=20%; MODEL=CR SERIES; TG=-55 DEGC TO +105 DEGC   | PCR1C471MCL6        | NICHICON                  |
| C118                                  | -       | 1   | 100UF          | CAPACITOR; SMT (7343); TANTALUM CHIP; 100UF; 16V; TOL=20%; MODEL=TQC SERIES                                      | 16TQC100MYF         | PANASONIC                 |
| C129                                  | -       | 1   | 2200PF         | CAPACITOR; SMT (0402); CERAMIC CHIP; 2200PF; 50V; TOL=10%; MODEL=C SERIES; TG=-55 DEGC TO +125 DEGC; TC=X7R      | C1005X7R1H222K050BA | TDK                       |
| D4, D5                                | -       | 2   | B360B-13-F     | DIODE; SCH; SCHOTTKY BARRIER DIODE; SMB; PIV=60V; Io=3A; -55 DEGC TO +125 DEGC                                   | B360B-13-F          | DIODES INCORPORATED       |
| D8                                    | -       | 1   | SML-210VTT86   | DIODE; LED; SML-21 SERIES; RED; SMT (0805); PIV=2V; IF=0.02A   | SML-210VTT86        | ROHM                      |
| L4, L5, FB1, FB3, FB5, FB6, FB8, FB14 | -       | 8   | 120            | INDUCTOR; SMT (0603); FERRITE-BEAD; 120; TOL=+/-25%; 3A  | BLM18SG121TN1       | MURATA                    |
| TP1, GND1-GND4, TP_12V                | -       | 6   | N/A            | TEST POINT; PIN DIA=0.1IN; TOTAL LENGTH=0.3IN; BOARD HOLE=0.04IN; RED; PHOSPHOR BRONZE WIRE SILVER PLATE FINISH; | 5000                | KEYSTONE                  |
| H1-1-H1-3                             | -       | 3   | PBC16SAAN      | CONNECTOR; MALE; THROUGH HOLE; BREAKAWAY; STRAIGHT; 16PINS; -65 DEGC TO +125 DEGC                                | PBC16SAAN           | SULLINS ELECTRONICS CORP. |
| H2                                    | -       | 1   | PPPC141LFBN-RC | CONNECTOR; FEMALE; THROUGH HOLE; LFB SERIES; 2.54MM CONTACT CENTER; STRAIGHT; 14PINS                             | PPPC141LFBN-RC      | SULLINS ELECTRONICS CORP  |
| H3                                    | -       | 1   | PPTC031LFBN-RC | CONNECTOR; FEMALE; THROUGH HOLE; HEADER; STRAIGHT THROUGH; 3PINS; -40 DEGC TO +105 DEGC                          | PPTC031LFBN-RC      | SULLINS                   |
| H4                                    | -       | 1   | PPPC021LFBN-RC | CONNECTOR; FEMALE; THROUGH HOLE; LFB SERIES; 2.54MM CONTACT CENTER; STRAIGHT; 2PINS                              | PPPC021LFBN-RC      | SULLINS ELECTRONICS CORP  |

| REF_DES   | DNI/DNP | QTY | VALUE          | DESCRIPTION  | MFG PART #     | MANUFACTURER              |
|---|---------|-----|----------------|--|----------------|---------------------------|
| J1  | -       | 1   | PJ-202BH       | CONNECTOR; MALE; THROUGH HOLE; PJ-202BH; DC POWER JACK; RIGHT ANGLE; RIGHT ANGLE; 3PINS  | PJ-202BH       | CUI INC.                  |
| J2, J3, J18-J20, J34                                      | -       | 6   | MAXIMPAD       | EVK KIT PARTS; MAXIM PAD; WIRE; NATURAL; SOLID; WEICO WIRE; SOFT DRAWN BUS TYPE-S; 20AWG | 9020 BUSS      | WEICO WIRE                |
| J4, J5  | -       | 2   | 59S2AX-400A5-Z | CONNECTOR; MALE; THROUGH HOLE; RIGHT ANGLE PLUG FOR PCB; RIGHT ANGLE; 5PINS              | 59S2AX-400A5-Z | ROSENBERGER               |
| J6  | -       | 1   | PEC04SAAN      | CONNECTOR; MALE; THROUGH HOLE; BREAKAWAY; STRAIGHT; 4PINS                                | PEC04SAAN      | SULLINS ELECTRONICS CORP. |
| J7  | -       | 1   | PBC14SAAN      | CONNECTOR; MALE; THROUGH HOLE; BREAKAWAY; STRAIGHT; 14PINS; -65 DEGC TO +125 DEGC        | PBC14SAAN      | SULLINS ELECTRONICS CORP. |
| J11, J13, J21, J22, J25, J30, J32, J35, J44-J46, J54, J55 | -       | 13  | PCC02SAAN      | CONNECTOR; MALE; THROUGH HOLE; BREAKAWAY; STRAIGHT THROUGH; 2PINS; -65 DEGC TO +125 DEGC | PCC02SAAN      | SULLINS                   |
| J23, J26-J29, J33, J39-J43, J47, J48, J53                 | -       | 14  | PCC03SAAN      | CONNECTOR; MALE; THROUGH HOLE; BREAKAWAY; STRAIGHT THROUGH; 3PINS; -65 DEGC TO +125 DEGC | PCC03SAAN      | SULLINS                   |
| J38, J50-J52, JU2   | -       | 5   | PEC04SAAN      | CONNECTOR; MALE; THROUGH HOLE; BREAKAWAY; STRAIGHT; 4PINS                                | PEC04SAAN      | SULLINS ELECTRONICS CORP. |
| J56-J60   | -       | 5   | PEC02SAAN      | CONNECTOR; MALE; THROUGH HOLE; BREAKAWAY; STRAIGHT; 2PINS                                | PEC02SAAN      | SULLINS                   |
| JU1   | -       | 1   | PBC05SAAN      | CONNECTOR; MALE; THROUGH HOLE; BREAKAWAY; STRAIGHT; 5PINS; -65 DEGC TO +125 DEGC         | PBC05SAAN      | SULLINS ELECTRONICS CORP. |
| JU3, JU4  | -       | 2   | PEC03SAAN      | CONNECTOR; MALE; THROUGH HOLE; BREAKAWAY; STRAIGHT; 3PINS                                | PEC03SAAN      | SULLINS                   |
| L1, L8  | -       | 2   | 330NH          | INDUCTOR; SMT (0603); FERRITE CORE; 330NH; TOL=+/-5%; 0.63A                              | LQW18CNR33J00  | MURATA                    |
| L2, L7  | -       | 2   | 6.8UH          | INDUCTOR; SMT (1210); WIREWOUND CHIP; 6.8UH; TOL=20%; 0.62A                              | LBC3225T6R8MR  | TAIYO YUDEN               |
| L3, L6  | -       | 2   | 100UH          | INDUCTOR; SMT (2424); WIREWOUND CHIP; 100UH; TOL=20%; 0.92A                              | LQH6PPN101M43L | MURATA                    |
| L25   | -       | 1   | 1.5UH          | INDUCTOR; SMT; FERRITE-BEAD; 1.5UH; TOL=+/-20%; 27A                                      | 7443330150     | WURTH ELECTRONICS INC.    |
| MECH1-MECH4   | -       | 4   | 1902B          | STANDOFF; FEMALE-THREADED; HEX; 4-40IN; 3/8IN; NYLON                                     | 1902B          | GENERIC PART              |



| REF_DES                             | DNI/DNP | QTY | VALUE          | DESCRIPTION  | MFG PART #                    | MANUFACTURER            |
|-------------------------------------|---------|-----|----------------|--|-------------------------------|-------------------------|
| MISC2                               | -       | 1   | MAXEVCNTR-NUV# | EVKIT PART-NUVOTON MICRO CONTROLLER  | MAXEVCNTR-NUV#                | MAXIM                   |
| N1, N2                              | -       | 2   | FDS8449        | TRAN; N-CHANNEL POWER TRENCH MOSFET; NCH; NSOIC8 ; PD-(2.5W); I-(7.6A); V-(40V)    | FDS8449                       | FAIRCHILD SEMICONDUCTOR |
| PCLK_SMA                            | -       | 1   | 5-1814832-1    | CONNECTOR; FEMALE; THROUGH HOLE; CONN SOCKET SMA STR DIE CAST PCB; STRAIGHT; 5PINS | 5-1814832-1                   | TYCO                    |
| R1                                  | -       | 1   | 0.015          | RESISTOR; 1206; 0.015 OHM; 5%; 200PPM; 1W; THICK FILM                              | ERJ-8BJR015V                  | PANASONIC               |
| R2                                  | -       | 1   | 14.3K          | RESISTOR, 0402, 14.3K OHM, 1%, 100PPM, 0.0625W, THICK FILM                         | CRCW040214K3FK                | VISHAY DALE             |
| R3, R5, R38                         | -       | 3   | 24.9K          | RESISTOR; 0603; 24.9K OHM; 1%; 100PPM; 0.10W; THICK FILM                           | CRCW060324K9FK                | VISHAY DALE             |
| R4                                  | -       | 1   | 41.2K          | RESISTOR; 0603; 41.2K OHM; 1%; 100PPM; 0.10W; METAL FILM                           | CRCW060341K2FK                | VISHAY DALE             |
| R6, R58                             | -       | 2   | 11K            | RESISTOR; 0603; 11K OHM; 1%; 100PPM; 0.10W; THICK FILM                             | CR0603-FX-1102ELF             | BOURNS                  |
| R7, R9, R11, R13-R15, R28, R29, R34 | -       | 9   | 2.2K           | RESISTOR, 0603, 2.2K OHM, 1%, 100PPM, 0.10W, THICK FILM                            | CRCW06032K20FK                | VISHAY DALE             |
| R12, R27, R37, R39                  | -       | 4   | 0              | RESISTOR; 0402; 0 OHM; 0%; JUMPER; 0.063W; THICK FILM                              | CRCW04020000ZS                | VISHAY DALE             |
| R16, R19                            | -       | 2   | 45.3K          | RESISTOR; 0603; 45.3KOHM; 1%; 100PPM; 0.10W; THICK FILM                            | CRCW060345K3FK; ERJ-3EKF4532V | VISHAY DALE/PANASONIC   |
| R17, R20                            | -       | 2   | 4.99K          | RESISTOR; 0201; 4.99K OHM; 1%; 100PPM; 0.05W ; THICK FILM                          | CRCW02014K99FK                | VISHAY DALE             |
| R18, R21                            | -       | 2   | 49.9K          | RESISTOR; 0201; 49.9K OHM; 1%; 100PPM; 0.05W ; THICK FILM                          | CRCW020149K9FK                | VISHAY DALE             |
| R22, R36                            | -       | 2   | 1K             | RESISTOR; 0603; 1K; 1%; 100PPM; 0.10W; THICK FILM                                  | CRCW06031001FK; ERJ-3EKF1001V | VISHAY DALE; PANASONIC  |
| R23                                 | -       | 1   | 2              | RESISTOR, 0603, 2 OHM, 1%, 100PPM, 0.10W, THICK FILM                               | CRCW06032R00FN                | VISHAY DALE             |
| R24, R25, R30, R31                  | -       | 4   | 2K             | RESISTOR, 0603, 2K OHM, 1%, 100PPM, 0.10W, THICK FILM                              | CRCW06032K0FK; ERJ-3EKF2001V  | VISHAY DALE/PANASONIC   |
| R26, R32                            | -       | 2   | 2K             | RESISTOR; 0201; 2K OHM; 1%; 200PPM; 0.05W; THICK FILM                              | ERJ-1GEF2001C                 | PANASONIC               |
| R33                                 | -       | 1   | 30K            | RESISTOR; 0603; 30K OHM; 1%; 100PPM; 0.10W; THICK FILM                             | CRCW060330K0FK                | VISHAY DALE             |

| REF_DES        | DNI/DNP | QTY | VALUE          | DESCRIPTION   | MFG PART #                                    | MANUFACTURER                        |
|----------------|---------|-----|----------------|---|---|-------------------------------------|
| R74            | -       | 1   | 30K            | RESISTOR; 0402; 30K OHM; 1%; 100PPM; 0.063W; THICK FILM   | RC0402FR-0730KL                               | YAGEO PHICOMP                       |
| R75, R76       | -       | 2   | 0              | RESISTOR; 0603; 0 OHM; 5%; JUMPER; 0.10W; THICK FILM  | RC1608J000CS; CR0603-J/-000ELF;RC0603JR-070RL | SAMSUNG ELECTRONICS/BOURNS/YAGEO PH |
| R100           | -       | 1   | 1K             | RESISTOR; 0603; 1K OHM; 1%; 100PPM; 0.10W; THICK FILM   | CR0603-FX-1001ELF                             | BOURNS                              |
| SCREW1-SCREW4  | -       | 4   | P440.375       | MACHINE SCREW; SLOTTED; PAN; 4-40IN; 3/8IN; NYLON   | P440.375                                      | GENERIC PART                        |
| SU1-SU25       | -       | 25  | STC02SYAN      | TEST POINT; JUMPER; STR; TOTAL LENGTH=0.256IN; BLACK; INSULATION=PBT CONTACT=PHOSPHOR BRONZE; COPPER PLATED TIN OVERALL | STC02SYAN                                     | SULLINS ELECTRONICS CORP.           |
| U1             | -       | 1   | MAX96705GTJ    | IC; HS81 PRELIMINARY; PACKAGE OUTLINE 32 TQFN; 0.50MM PITCH; 21-0140/T3255-8; MAX96705                                  | MAX96705GTJ                                   | MAXIM                               |
| U2,U3,U12      | -       | 3   | MAX1792EUA33   | IC; VREG; LOW-DROPOUT LINEAR REGULATOR; UMAX8   | MAX1792EUA33                                  | MAXIM                               |
| U4             | -       | 1   | IDT8N0Q001     | EVKIT PART; IC; IDT8N0Q001; CD10 PACKAGE OUTLINE 7X5 BODY; 2.54MM PITCH; CUSTOM PART ONLY                               | IDT8N0Q001                                    | IDT                                 |
| U15            | -       | 1   | MAX3378EEUD+   | IC; TRANS; +/-15KV ESD-PROTECTED, 1UA, 16MBPS, QUAD LOW-VOLTAGE LEVEL TRANSLATOR; TSSOP14                               | MAX3378EEUD+                                  | MAXIM                               |
| U23            | -       | 1   | MAX16952AUE/V+ | IC; CTRL; STEP-DOWN CONTROLLER WITH LOW OPERATING CURRENT; TSSOP16-EP   | MAX16952AUE/V+                                | MAXIM                               |
| MISC1          | DNI     | 1   | AK67421-1-R    | CONNECTOR; MALE; USB; USB2.0 MICRO CONNECTION CABLE; USB B MICRO MALE TO USB A MALE; STRAIGHT; 5PINS-4PINS              | AK67421-1-R                                   | ASSMANN                             |
| C37, C59, C128 | DNP     | 3   | OPEN           | PACKAGE OUTLINE 0603 NON-POLAR CAPACITOR  | N/A   | N/A                                 |
| DB1            | DNP     | 1   | TEENSY 3.1     | EVKIT PART; MODULE; CTRL; TEENSY USB DEVELOPMENT BOARD; TH-37; CUSTOM PART ONLY   | TEENSY 3.1                                    | PJRC                                |

TOTAL 234

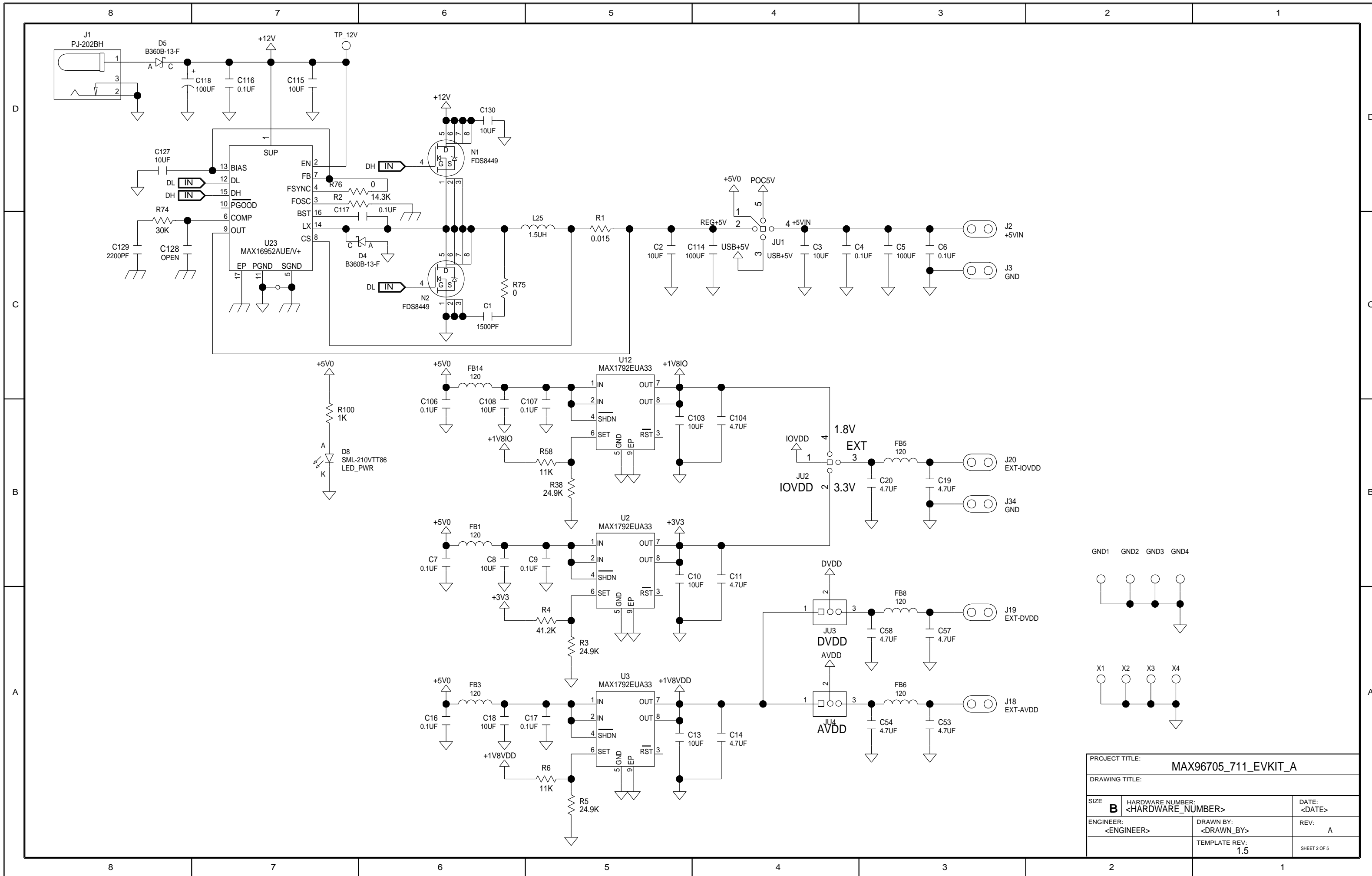

|                      |                   |              |
|----------------------|-------------------|--------------|
| PROJECT TITLE:       |                   |              |
| MAX96705_711_EVKIT_A |                   |              |
| DRAWING TITLE:       |                   |              |
| SIZE                 | HARDWARE NUMBER:  | DATE:        |
| B                    | <HARDWARE_NUMBER> | <DATE>       |
| ENGINEER:            | DRAWN BY:         | REV:         |
| <ENGINEER>           | <DRAWN_BY>        | A            |
| TEMPLATE REV:        |                   | SHEET 2 OF 5 |
| 1.5                  |                   |              |

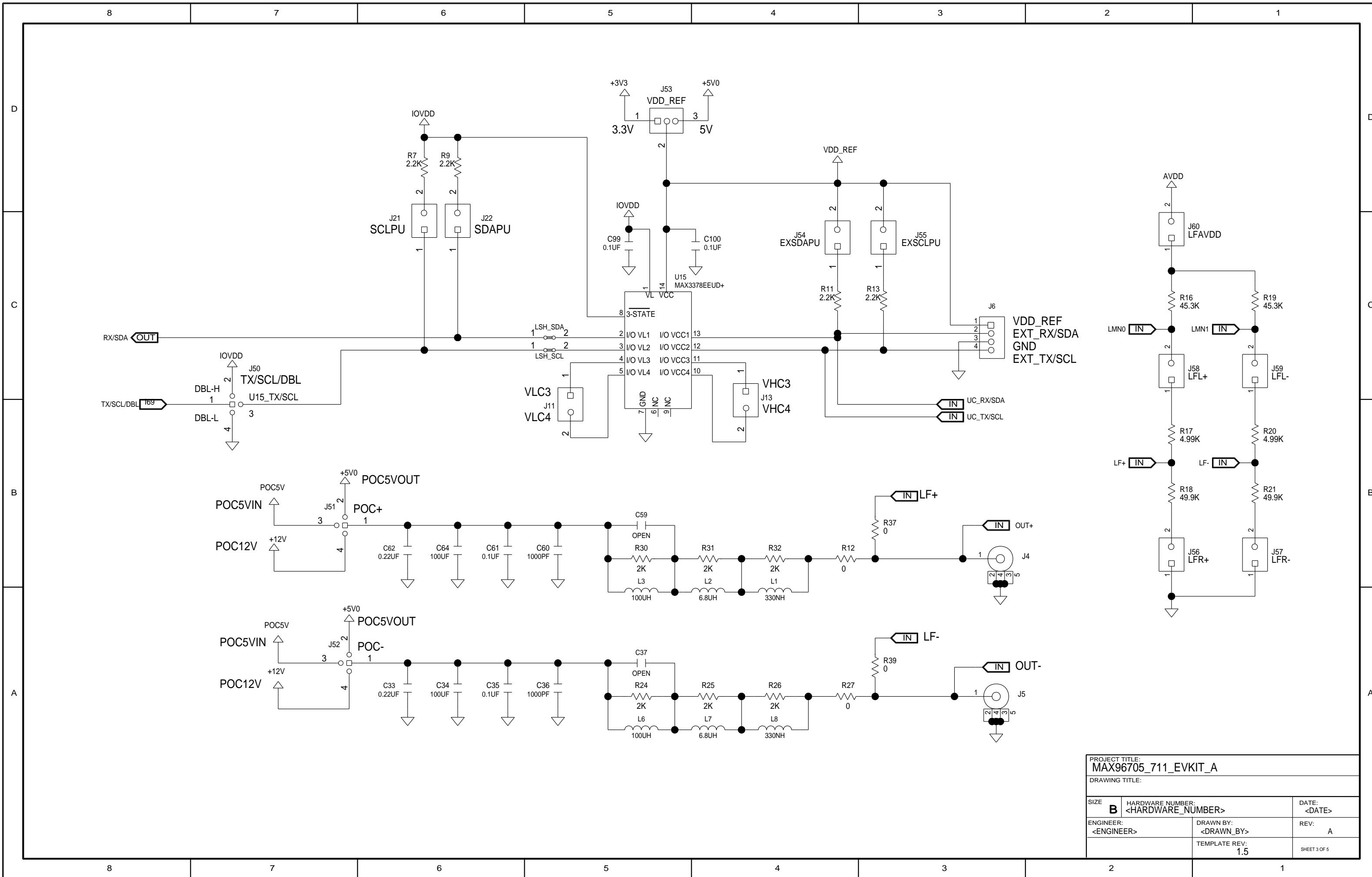

|  |                                       |                 |
|--|---------------------------------------|-----------------|
| PROJECT TITLE:<br>MAX96705_711_EVKIT_A |                                       |                 |
| DRAWING TITLE:                         |                                       |                 |
| SIZE<br><b>B</b>                       | HARDWARE NUMBER:<br><HARDWARE_NUMBER> | DATE:<br><DATE> |
| ENGINEER:<br><ENGINEER>                | DRAWN BY:<br><DRAWN_BY>               | REV:<br>A       |
| TEMPLATE REV:<br>1.5                   |                                       | SHEET 3 OF 5    |

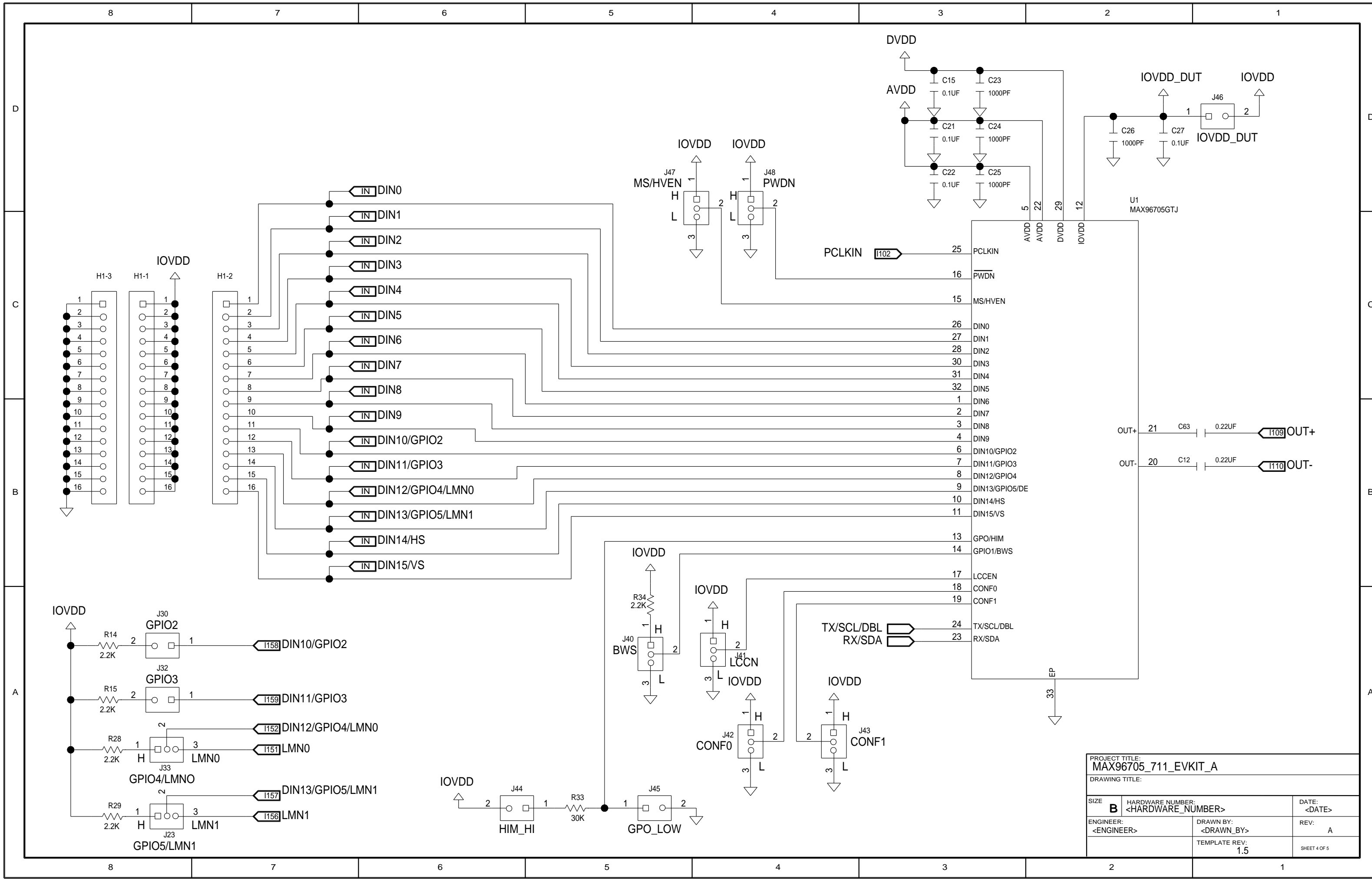

|  |                                       |                 |
|--|---------------------------------------|-----------------|
| PROJECT TITLE:<br>MAX96705_711_EVKIT_A |                                       |                 |
| DRAWING TITLE:                         |                                       |                 |
| SIZE<br><b>B</b>                       | HARDWARE NUMBER:<br><HARDWARE_NUMBER> | DATE:<br><DATE> |
| ENGINEER:<br><ENGINEER>                | DRAWN BY:<br><DRAWN_BY>               | REV:<br>A       |
| TEMPLATE REV:<br>1.5                   |                                       | SHEET 4 OF 5    |

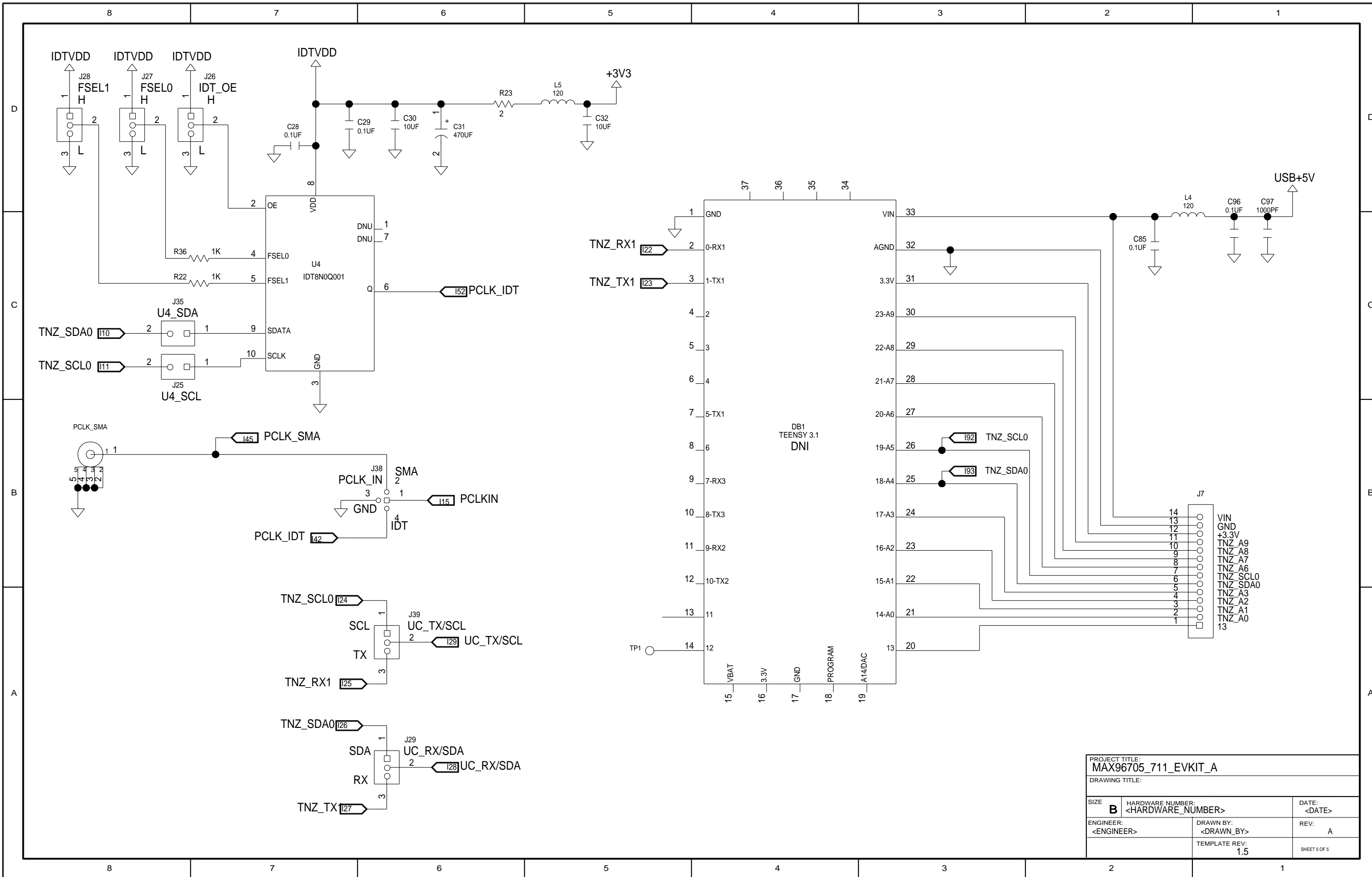

|  |                                       |                 |
|--|---------------------------------------|-----------------|
| PROJECT TITLE:<br>MAX96705_711_EVKIT_A |                                       |                 |
| DRAWING TITLE:                         |                                       |                 |
| SIZE<br><b>B</b>                       | HARDWARE NUMBER:<br><HARDWARE_NUMBER> | DATE:<br><DATE> |
| ENGINEER:<br><ENGINEER>                | DRAWN BY:<br><DRAWN_BY>               | REV:<br>A       |
| TEMPLATE REV:<br>1.5                   |                                       | SHEET 5 OF 5    |



This document contains information considered proprietary, and shall not be reproduced wholly or in part, nor disclosed to others without specific written permission.

HARDWARE NAME: MAX96705\_711\_EVKIT\_A

HARDWARE NUMBER:

ENGINEER:

DESIGNER:

DATE: 07/29/2015

ODB++/GERBER: SILK\_TOP

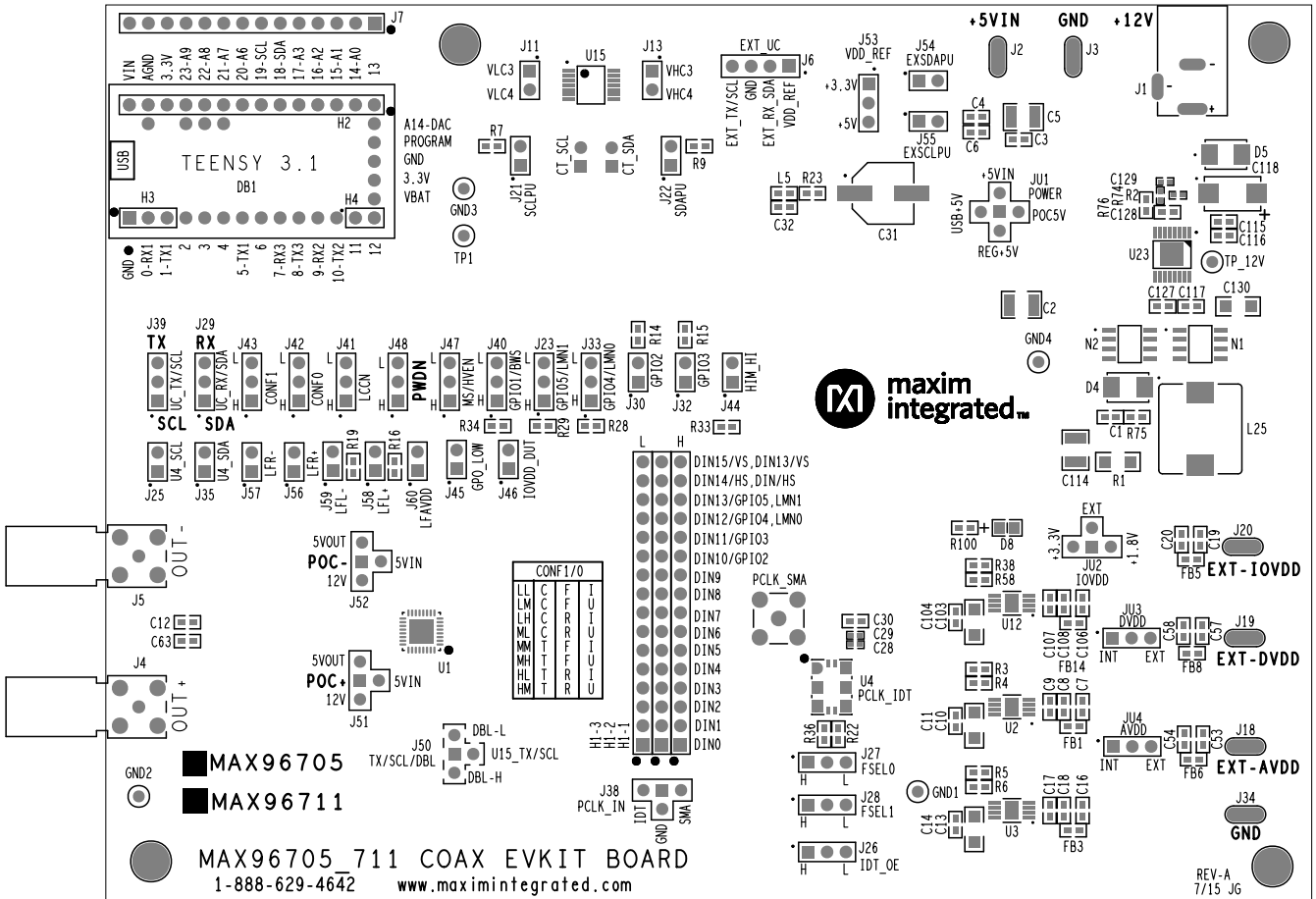



This document contains information considered proprietary, and shall not be reproduced wholly or in part, nor disclosed to others without specific written permission.

HARDWARE NAME: MAX96705\_711\_EVKIT\_A

HARDWARE NUMBER:

ENGINEER:

DESIGNER:

DATE: 07/29/2015

ODB++/GERBER: TOP

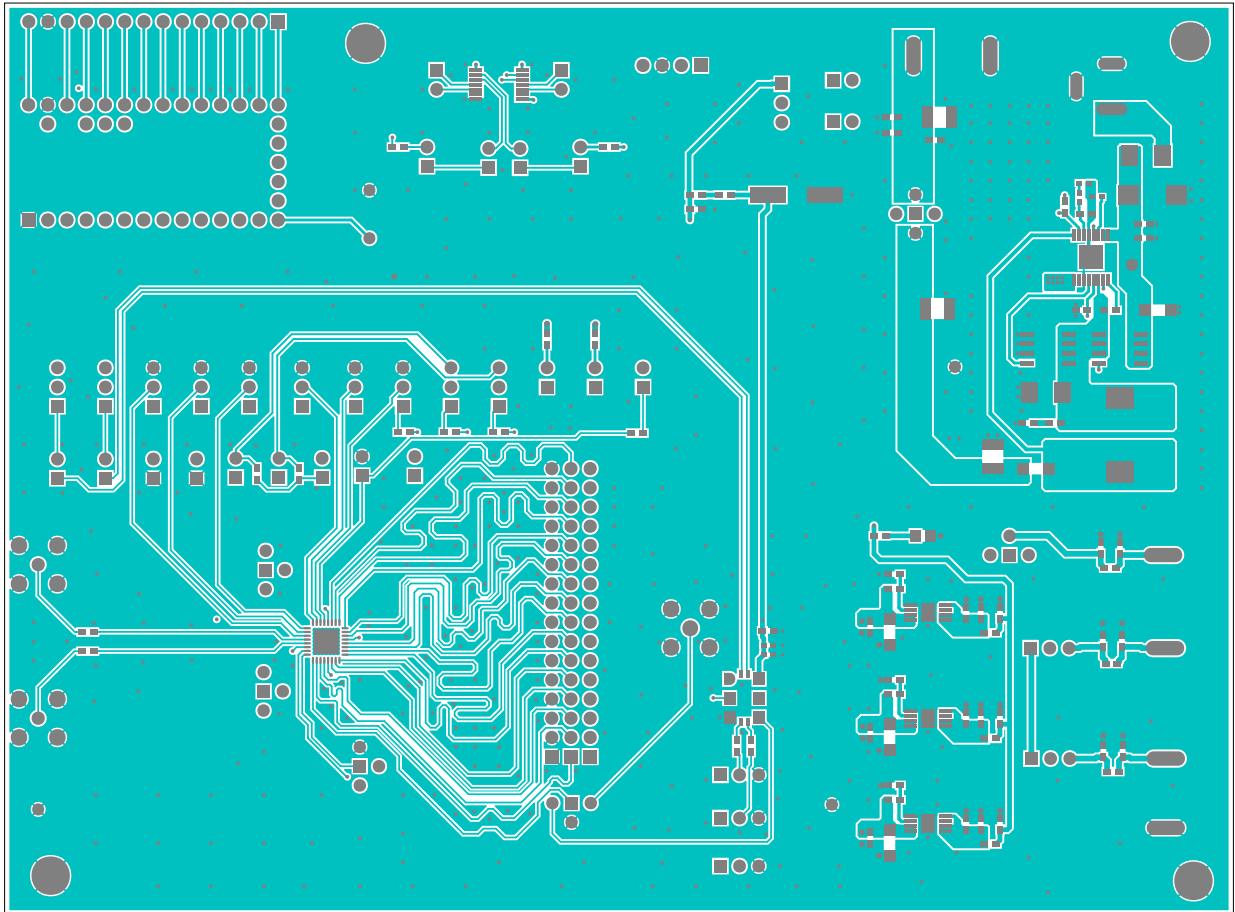





This document contains information considered proprietary, and shall not be reproduced wholly or in part, nor disclosed to others without specific written permission.

HARDWARE NAME: MAX96705\_711\_EVKIT\_A

HARDWARE NUMBER:

ENGINEER:

DESIGNER:

DATE: 07/29/2015

ODB++/GERBER: INNER\_LAYER2

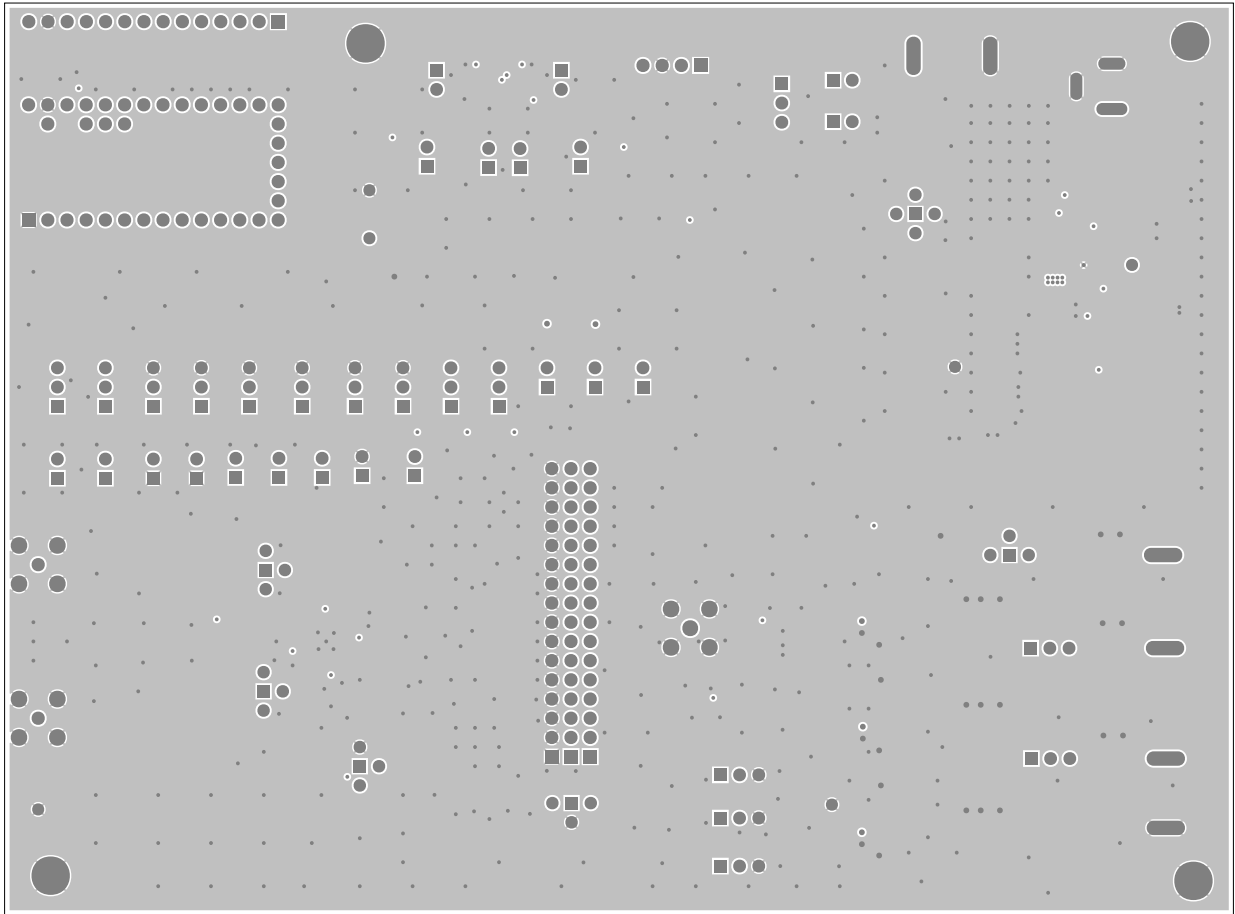



This document contains information considered proprietary, and shall not be reproduced wholly or in part, nor disclosed to others without specific written permission.

HARDWARE NAME: MAX96705\_711\_EVKIT\_A

HARDWARE NUMBER:

ENGINEER:

DESIGNER:

DATE: 07/29/2015

ODB++/GERBER: **INNER\_LAYER3**

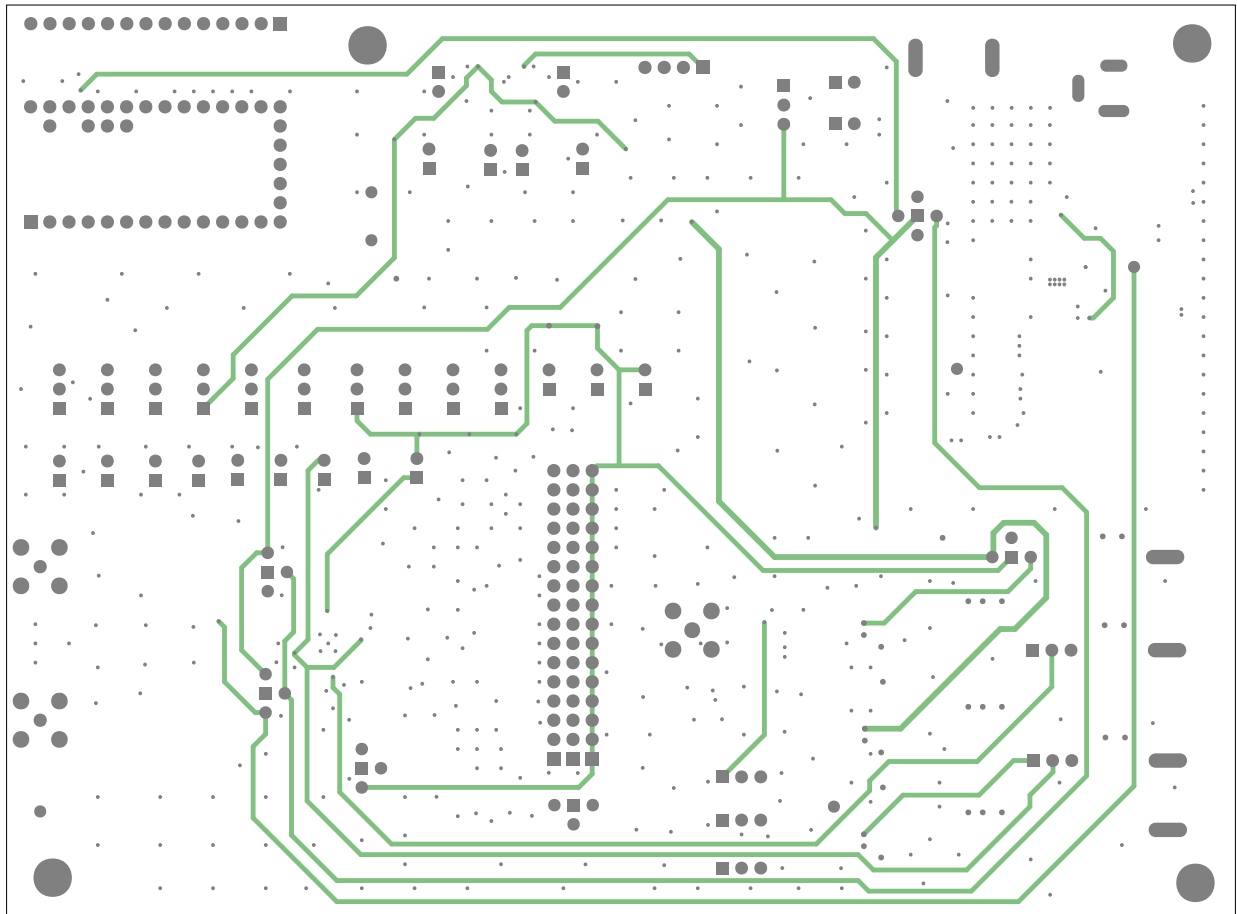



This document contains information considered proprietary, and shall not be reproduced wholly or in part, nor disclosed to others without specific written permission.

HARDWARE NAME: MAX96705\_711\_EVKIT\_A

HARDWARE NUMBER:

ENGINEER:

DESIGNER:

DATE: 07/29/2015

ODB++/GERBER: **BOTTOM**

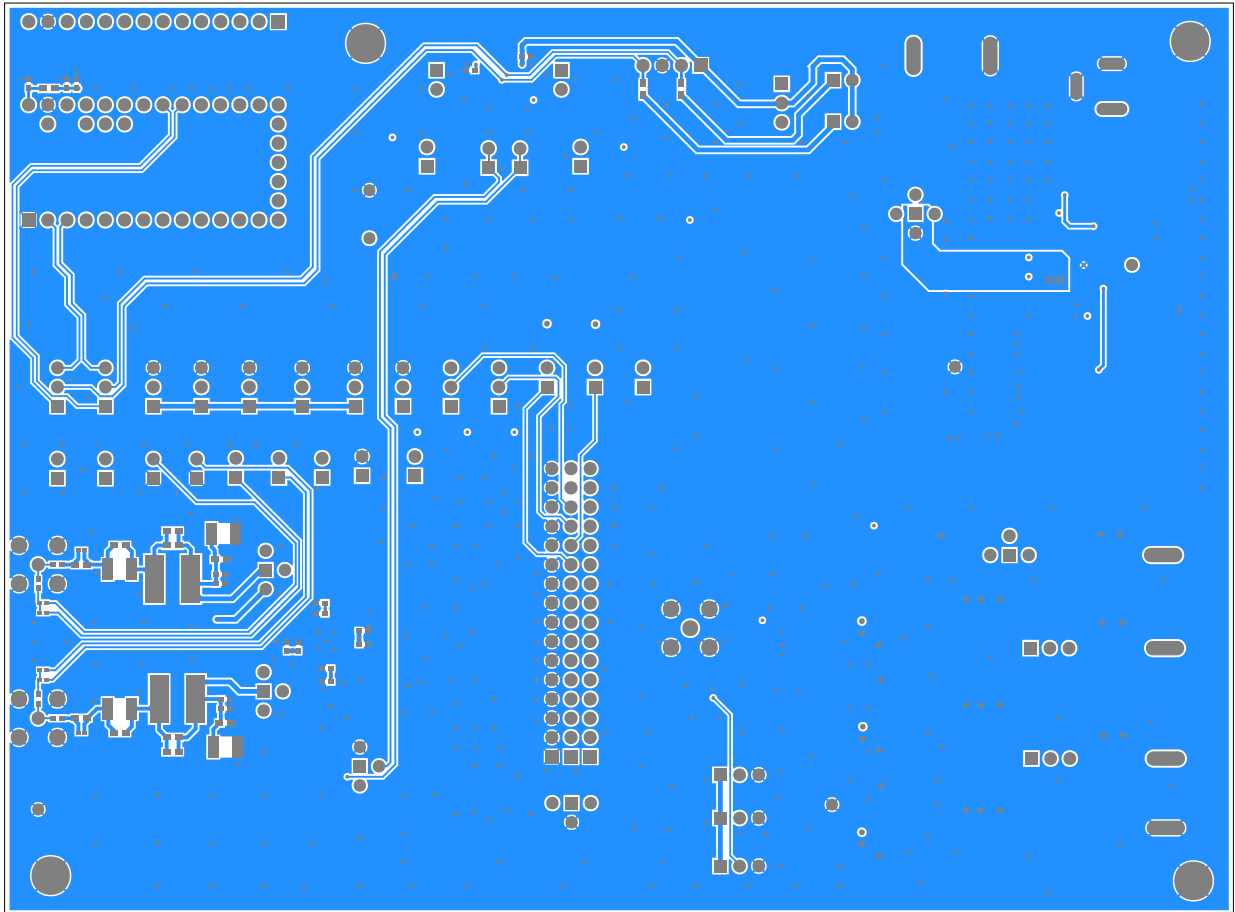



This document contains information considered proprietary, and shall not be reproduced wholly or in part, nor disclosed to others without specific written permission.

HARDWARE NAME: MAX96705\_711\_EVKIT\_A

HARDWARE NUMBER:

ENGINEER:

DESIGNER:

DATE: 07/29/2015

ODB++/GERBER: SILK\_BOT

