



# High-Speed, Low-Power, Single-Supply Multichannel, Video Multiplexer-Amplifiers

## General Description

The MAX4310–MAX4315 single-supply mux-amps combine high-speed operation, low-glitch switching, and excellent video specifications. The six products in this family are differentiated by the number of multiplexer inputs and the gain configuration. The MAX4310/MAX4311/MAX4312 integrate 2-/4-/8-channel multiplexers, respectively, with an adjustable gain amplifier optimized for unity-gain stability. The MAX4313/MAX4314/MAX4315 integrate 2-/4-/8-channel multiplexers, respectively, with a +2V/V fixed-gain amplifier. All devices have 40ns channel switching time and low 10mVp-p switching transients, making them ideal for video-switching applications. They operate from a single +4V to +10.5V supply, or from dual supplies of  $\pm 2V$  to  $\pm 5.25V$ , and they feature rail-to-rail outputs and an input common-mode voltage range that extends to the negative supply rail.

The MAX4310/MAX4311/MAX4312 have a -3dB bandwidth of 280MHz/345MHz/265MHz and up to a 460V/ $\mu$ s slew rate. The MAX4313/MAX4314/MAX4315, with 150MHz/127MHz/97MHz -3dB bandwidths up to a 540V/ $\mu$ s slew rate, and a fixed gain of +2V/V, are ideally suited for driving back-terminated cables. Quiescent supply current is as low as 6.1mA, while low-power shutdown mode reduces supply current to as low as 560 $\mu$ A and places the outputs in a high-impedance state. The MAX4310–MAX4315's internal amplifiers maintain an open-loop output impedance of only 8 $\Omega$  over the full output voltage range, minimizing the gain error and bandwidth changes under loads typical of most rail-to-rail amplifiers. With differential gain and phase errors of 0.06% and 0.08°, respectively, these devices are ideal for broadcast video applications.

## Applications

Video Signal Multiplexing	Broadcast Video
Video Crosspoint Switching	Medical Imaging
Flash ADC Input Buffers	Multimedia Products
75 $\Omega$ Video Cable Drivers	
High-Speed Signal Processing	

## Features

- ◆ Single-Supply Operation Down to +4V
- ◆ 345MHz -3dB Bandwidth (MAX4311)  
150MHz -3dB Bandwidth (MAX4313)
- ◆ 540V/ $\mu$ s Slew Rate (MAX4313)
- ◆ Low 6.1mA Quiescent Supply Current
- ◆ 40ns Channel Switching Time
- ◆ Ultra-Low 10mVp-p Switching Transient
- ◆ 0.06%/0.08° Differential Gain/Phase Error
- ◆ Rail-to-Rail Outputs: Drives 150 $\Omega$  to within 730mV of the Rails
- ◆ Input Common-Mode Range Includes Negative Rail
- ◆ Low-Power Shutdown Mode
- ◆ Available in Space-Saving 8-Pin  $\mu$ MAX® and 16-Pin QSOP Packages

## Ordering Information

PART	TEMP RANGE	PIN-PACKAGE
MAX4310EUA	-40°C to +85°C	8 $\mu$ MAX
MAX4310ESA	-40°C to +85°C	8 SO
MAX4311EEE	-40°C to +85°C	16 QSOP
MAX4311ESD	-40°C to +85°C	14 Narrow SO
MAX4312EEE	-40°C to +85°C	16 QSOP
MAX4312ESE	-40°C to +85°C	16 Narrow SO
MAX4313EUA	-40°C to +85°C	8 $\mu$ MAX
MAX4313ESA	-40°C to +85°C	8 SO
MAX4314EEE	-40°C to +85°C	16 QSOP
MAX4314ESD	-40°C to +85°C	14 Narrow SO
MAX4315EEE	-40°C to +85°C	16 QSOP
MAX4315ESE	-40°C to +85°C	16 Narrow SO

Pin Configurations and Typical Operating Circuit appear at end of data sheet.

$\mu$ Max is a registered trademark of Maxim Integrated Products, Inc.

## Selector Guide

PART	NO. OF INPUT CHANNELS	AMPLIFIER GAIN (V/V)	PIN-PACKAGE
MAX4310	2	$\geq +1$	8-Pin SO/ $\mu$ MAX
MAX4311	4	$\geq +1$	14-Pin Narrow SO, 16-Pin QSOP
MAX4312	8	$\geq +1$	16-Pin Narrow SO/QSOP
MAX4313	2	+2	8-Pin SO/ $\mu$ MAX
MAX4314	4	+2	14-Pin Narrow SO, 16-Pin QSOP
MAX4315	8	+2	16-Pin Narrow SO/QSOP



# High-Speed, Low-Power, Single-Supply Multichannel, Video Multiplexer-Amplifiers

## ABSOLUTE MAXIMUM RATINGS

Supply Voltage (V <sub>CC</sub> to V <sub>EE</sub> )	..... 12V	14-Pin SO (derate 8.3mW/°C above +70°C)	.....667mW
Input Voltage	.....(V <sub>EE</sub> - 0.3V) to (V <sub>CC</sub> + 0.3V)	16-Pin SO (derate 8.7mW/°C above +70°C)	.....696mW
All Other Pins	.....(V <sub>EE</sub> - 0.3V) to (V <sub>CC</sub> + 0.3V)	16-Pin QSOP (derate 8.3mW/°C above +70°C)	.....667mW
Output Current	.....±120mA	Operating Temperature Range	.....-40°C to +85°C
Short-Circuit Duration (V <sub>OUT</sub> to GND, V <sub>CC</sub> or V <sub>EE</sub> )	.....Continuous	Storage Temperature Range	.....-65°C to +150°C
Continuous Power Dissipation (T <sub>A</sub> = +70°C)		Lead Temperature (soldering, 10s)	.....+300°C
8-Pin SO (derate 5.9mW/°C above +70°C)	.....471mW		
8-Pin μMAX (derate 4.1mW/°C above +70°C)	.....330mW		

Stresses beyond those listed under "Absolute Maximum Ratings" may cause permanent damage to the device. These are stress ratings only, and functional operation of the device at these or any other conditions beyond those indicated in the operational sections of the specifications is not implied. Exposure to absolute maximum rating conditions for extended periods may affect device reliability.

## DC ELECTRICAL CHARACTERISTICS

(V<sub>CC</sub> = +5V, V<sub>EE</sub> = 0V,  $\overline{\text{SHDN}} \geq 4\text{V}$ , R<sub>L</sub> = ∞, V<sub>OUT</sub> = 2.5V, T<sub>A</sub> = T<sub>MIN</sub> to T<sub>MAX</sub>, unless otherwise noted. Typical values are at T<sub>A</sub> = +25°C.)

PARAMETER	SYMBOL	CONDITIONS	MIN	TYP	MAX	UNITS
Operating Supply Voltage Range	V <sub>CC</sub>	Inferred from PSRR test	4.0		10.5	V
Input Voltage Range		MAX4310/MAX4311/MAX4312, inferred from CMRR test	0.035	V <sub>CC</sub> - 2.8		V
		MAX4313/MAX4314/MAX4315, inferred from output voltage swing	0.035	V <sub>CC</sub> - 2.7		
Common-Mode Rejection Ratio	CMRR	0 ≤ V <sub>CM</sub> ≤ 2.2V, MAX4310/MAX4311/MAX4312 only	73	95		dB
Input Offset Voltage	V <sub>OS</sub>			±5.0	±20	mV
Input Offset Voltage Drift	TC <sub>VOS</sub>			±7		μV/°C
Input Offset Voltage Matching				±1		mV
Input Bias Current	I <sub>B</sub>	I <sub>IN</sub>		7	14	μA
Feedback Bias Current	I <sub>FB</sub>	I <sub>FB</sub> , MAX4310/MAX4311/MAX4312 only		7	14	μA
Input Offset Current	I <sub>OS</sub>	MAX4310/MAX4311/MAX4312 only		0.1	2	μA
Common-Mode Input Resistance	R <sub>IN</sub>	V <sub>IN</sub> varied over V <sub>CM</sub> , MAX4310/MAX4311/MAX4312 only		3		MΩ
Differential Input Resistance	R <sub>IN</sub>			70		KΩ
Output Resistance	R <sub>OUT</sub>	MAX4310/MAX4311/ MAX4312 only	Open loop	8		Ω
			Closed loop, A <sub>v</sub> = +1V/V	0.025		
		MAX4313/MAX4314/MAX4315		0.025		
Disabled Output Resistance	R <sub>OUT</sub>	MAX4310/MAX4311/MAX4312, open loop		35		Ω
		MAX4313/MAX4314/MAX4315		1		
Open-Loop Gain	A <sub>VOL</sub>	MAX4310/MAX4311/MAX4312, R <sub>L</sub> = 150Ω to GND, 0.25V ≤ V <sub>OUT</sub> ≤ 4.2V	50	59		dB
Voltage Gain	A <sub>VCL</sub>	MAX4313/MAX4314/MAX4315, R <sub>L</sub> = 150Ω to GND, 0.25V ≤ V <sub>OUT</sub> ≤ 4.2V	1.9	2.0	2.1	V/V

# High-Speed, Low-Power, Single-Supply Multichannel, Video Multiplexer-Amplifiers

MAX4310-MAX4315

## DC ELECTRICAL CHARACTERISTICS (continued)

( $V_{CC} = +5V$ ,  $V_{EE} = 0V$ ,  $\overline{SHDN} \geq 4V$ ,  $R_L = \infty$ ,  $V_{OUT} = 2.5V$ ,  $T_A = T_{MIN}$  to  $T_{MAX}$ , unless otherwise noted. Typical values are at  $T_A = +25^\circ C$ .)

PARAMETER	SYMBOL	CONDITIONS	MIN	TYP	MAX	UNITS
Output Voltage Swing	$V_{OUT}$	$R_L = 150\Omega$	$V_{CC} - V_{OH}$	0.73	0.9	V
			$V_{OL} - V_{EE}$	0.03	0.06	
		$R_L = 10k\Omega$	$V_{CC} - V_{OH}$	0.25	0.4	
			$V_{OL} - V_{EE}$	0.04	0.07	
Output Current	$I_{OUT}$	$R_L = 30\Omega$	$\pm 75$	$\pm 95$		mA
Power-Supply Rejection Ratio	PSRR	$V_{CC} = 4.0V$ to $10.5V$	52	63		dB
Quiescent Supply Current	$I_{CC}$	MAX4310/MAX4313		6.1	7.8	mA
		MAX4311/MAX4314		6.9	8.8	
		MAX4312/MAX4315		7.4	9.4	
Shutdown Supply Current		$\overline{SHDN} \leq V_{IL}$		560	750	$\mu A$
<b>LOGIC CHARACTERISTICS</b> ( $\overline{SHDN}$ , A0, A1, A2)						
Logic-Low Threshold	$V_{IL}$				$V_{EE} + 1$	V
Logic-High Threshold	$V_{IH}$		$V_{CC} - 1$			V
Logic-Low Input Current	$I_{IL}$	$V_{IL} \leq V_{EE} + 1V$	-500	-320		$\mu A$
Logic-High Input Current	$I_{IH}$	$V_{IH} \geq V_{CC} - 1V$		0.3	5	$\mu A$

## AC ELECTRICAL CHARACTERISTICS

( $V_{CC} = +5V$ ,  $V_{EE} = 0V$ ,  $\overline{SHDN} \geq 4V$ ,  $R_L = 150\Omega$ ,  $V_{CM} = 1.5V$ ,  $A_{VCL} = +1V/V$  (MAX4310/MAX4311/MAX4312),  $A_{VCL} = +2V/V$  (MAX4313/MAX4314/MAX4315),  $T_A = +25^\circ C$ , unless otherwise noted.)

PARAMETER	SYMBOL	CONDITIONS	MIN	TYP	MAX	UNITS
-3dB Bandwidth	$BW_{(-3dB)}$	$V_{OUT} = 100mVp-p$	MAX4310		280	MHz
			MAX4311		345	
			MAX4312		265	
			MAX4313		150	
			MAX4314		127	
			MAX4315		97	
-0.1dB Bandwidth	$BW_{(-0.1dB)}$	$V_{OUT} = 100mVp-p$	MAX4310		60	MHz
			MAX4311		40	
			MAX4312		35	
			MAX4313		40	
			MAX4314		78	
			MAX4315		46	

# High-Speed, Low-Power, Single-Supply Multichannel, Video Multiplexer-Amplifiers

## AC ELECTRICAL CHARACTERISTICS (continued)

( $V_{CC} = +5V$ ,  $V_{EE} = 0V$ ,  $\overline{SHDN} \geq 4V$ ,  $R_L = 150\Omega$ ,  $V_{CM} = 1.5V$ ,  $A_{VCL} = +1V/V$  (MAX4310/MAX4311/MAX4312),  $A_{VCL} = +2V/V$  (MAX4313/MAX4314/MAX4315),  $T_A = +25^\circ C$ , unless otherwise noted.)

PARAMETER	SYMBOL	CONDITIONS		MIN	TYP	MAX	UNITS
Full-Power Bandwidth	FPBW	$V_{OUT} = 2V_{p-p}$	MAX4310		110		MHz
			MAX4311		100		
			MAX4312		80		
			MAX4313		40		
			MAX4314		90		
			MAX4315		70		
Slew Rate	SR	$V_{OUT} = 2V_{p-p}$	MAX4310		460		
			MAX4311		430		
			MAX4312		345		
			MAX4313		540		
			MAX4314		430		
			MAX4315		310		
Settling Time to 0.1%	$t_s$	$V_{OUT} = 2V_{p-p}$	MAX4310/MAX4311/MAX4312		42		ns
			MAX4313/MAX4314/MAX4315		25		
Gain Matching		Matching between channels over -3dB bandwidth			0.05		dB
Differential Gain Error	DG	$A_{VCL} = +1V/V$ , $R_L = 150\Omega$ to $V_{CC}/2$	MAX4310/MAX4311/ MAX4312		0.06		%
		$R_L = 150\Omega$ to $V_{CC}/2$	MAX4313/MAX4314/ MAX4315		0.09		
Differential Phase Error	DG	$A_{VCL} = +1V/V$ , $R_L = 150\Omega$ to $V_{CC}/2$	MAX4310/MAX4311/ MAX4312		0.08		degrees
		$R_L = 150\Omega$ to $V_{CC}/2$	MAX4313/MAX4314/ MAX4315		0.03		
Spurious-Free Dynamic Range	SFDR	$V_{OUT} = 2V_{p-p}$	MAX4310/ MAX4311/ MAX4312	$f = 3kHz$	-89		dBc
				$f = 2kHz$	-80		
				$f = 20kHz$	-47		
			MAX4313/ MAX4314/ MAX4315	$f = 3kHz$	-95		
				$f = 2kHz$	-72		
				$f = 20kHz$	-47		
Second Harmonic Distortion		$f = 1MHz$ , $V_{OUT} = 2V_{p-p}$	MAX4310/MAX4311/MAX4312		-85		dBc
			MAX4313/MAX4314/MAX4315		-76		
Third Harmonic Distortion		$f = 1MHz$ , $V_{OUT} = 2V_{p-p}$	MAX4310/MAX4311/MAX4312		-88		dBc
			MAX4313/MAX4314/MAX4315		-95		
Total Harmonic Distortion	THD	$f = 1MHz$ , $V_{OUT} = 2V_{p-p}$	MAX4310/MAX4311/MAX4312		-83		dBc
			MAX4313/MAX4314/MAX4315		-76		

# High-Speed, Low-Power, Single-Supply Multichannel, Video Multiplexer-Amplifiers

MAX4310-MAX4315

## AC ELECTRICAL CHARACTERISTICS (continued)

( $V_{CC} = +5V$ ,  $V_{EE} = 0V$ ,  $\overline{SHDN} \geq 4V$ ,  $R_L = 150\Omega$ ,  $V_{CM} = 1.5V$ ,  $A_{VCL} = +1V/V$  (MAX4310/MAX4311/MAX4312),  $A_{VCL} = +2V/V$  (MAX4313/MAX4314/MAX4315),  $T_A = +25^\circ C$ , unless otherwise noted.)

PARAMETER	SYMBOL	CONDITIONS	MIN	TYP	MAX	UNITS
All-Hostile Crosstalk		f = 10MHz, $V_{IN} = 2V_{p-p}$	MAX4310/MAX4313	-95		dB
			MAX4311/MAX4314	-60		
			MAX4312/MAX4315	-52		
Off-Isolation		$\overline{SHDN} = 0$ , f = 10MHz, $V_{IN} = 2V_{p-p}$		-82		dB
Output Impedance	$Z_{OUT}$	f = 10MHz		3		$\Omega$
Input Capacitance	$C_{IN}$	Channel on or off		2		pF
Input Voltage-Noise Density	$e_n$	f = 10kHz		14		nV/ $\sqrt{Hz}$
Input Current-Noise Density	$i_n$	f = 10kHz		1.3		pA/ $\sqrt{Hz}$
<b>SWITCHING CHARACTERISTICS</b>						
Channel Switching Time	$t_{SW}$			40		ns
Enable Time from Shutdown	$t_{ON}$			50		ns
Disable Time to Shutdown	$t_{OFF}$			120		ns
Switching Transient				10		mVp-p

## Typical Operating Characteristics

( $V_{CC} = +5V$ ,  $V_{EE} = 0V$ ,  $\overline{SHDN} \geq 4V$ ,  $R_L = 150\Omega$  to  $V_{CC}/2$ ,  $V_{CM} = 1.5V$ ,  $A_{VCL} = +1V/V$  (MAX4310/MAX4311/MAX4312),  $A_{VCL} = +2V/V$  (MAX4313/MAX4314/MAX4315),  $T_A = +25^\circ C$ , unless otherwise noted.)



# High-Speed, Low-Power, Single-Supply Multichannel, Video Multiplexer-Amplifiers

## Typical Operating Characteristics (continued)

( $V_{CC} = +5V$ ,  $V_{EE} = 0V$ ,  $\overline{SHDN} \geq 4V$ ,  $R_L = 150\Omega$  to  $V_{CC}/2$ ,  $V_{CM} = 1.5V$ ,  $A_{VCL} = +1V/V$  (MAX4310/MAX4311/MAX4312),  $A_{VCL} = +2V/V$  (MAX4313/MAX4314/MAX4315),  $T_A = +25^\circ C$ , unless otherwise noted.)



# High-Speed, Low-Power, Single-Supply Multichannel, Video Multiplexer-Amplifiers

## Typical Operating Characteristics (continued)

( $V_{CC} = +5V$ ,  $V_{EE} = 0V$ ,  $\overline{SHDN} \geq 4V$ ,  $R_L = 150\Omega$  to  $V_{CC}/2$ ,  $V_{CM} = 1.5V$ ,  $A_{VCL} = +1V/V$  (MAX4310/MAX4311/MAX4312),  $A_{VCL} = +2V/V$  (MAX4313/MAX4314/MAX4315),  $T_A = +25^\circ C$ , unless otherwise noted.)

MAX4310-MAX4315

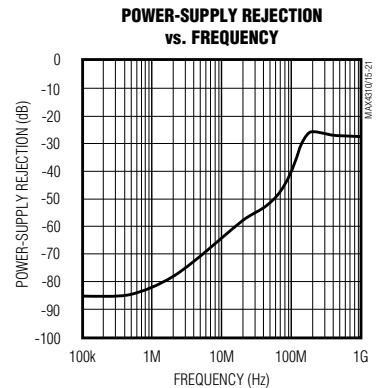
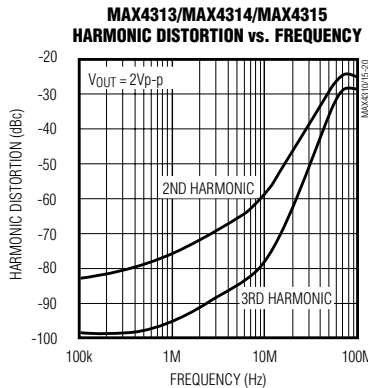
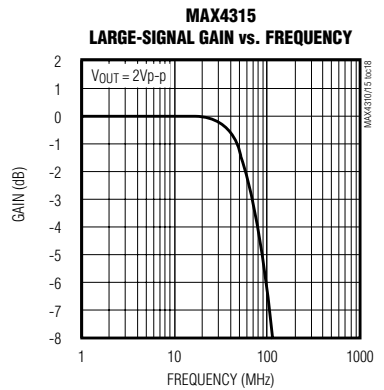
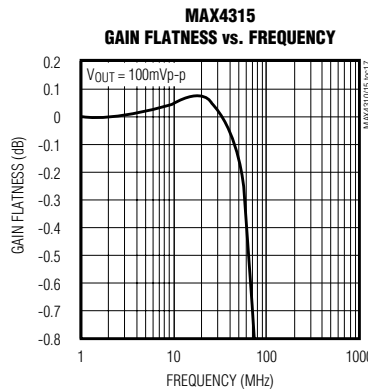
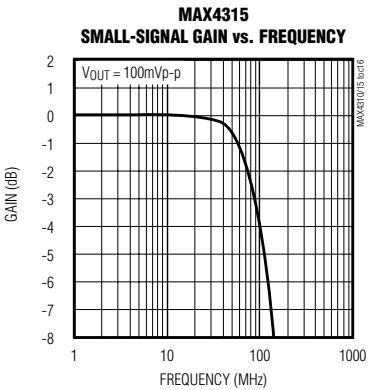
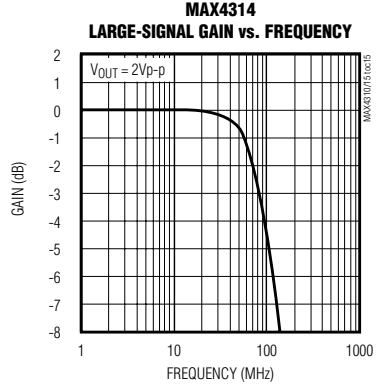
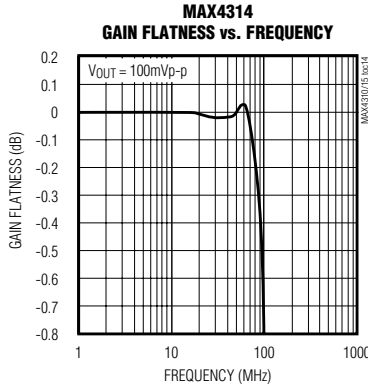

# High-Speed, Low-Power, Single-Supply Multichannel, Video Multiplexer-Amplifiers

## Typical Operating Characteristics (continued)

( $V_{CC} = +5V$ ,  $V_{EE} = 0V$ ,  $\overline{SHDN} \geq 4V$ ,  $R_L = 150\Omega$  to  $V_{CC}/2$ ,  $V_{CM} = 1.5V$ ,  $A_{VCL} = +1V/V$  (MAX4310/MAX4311/MAX4312),  $A_{VCL} = +2V/V$  (MAX4313/MAX4314/MAX4315),  $T_A = +25^\circ C$ , unless otherwise noted.)

**MAX4310/MAX4311/MAX4312  
COMMON-MODE REJECTION vs. FREQUENCY**



**OFF-ISOLATION vs. FREQUENCY**



**MAX4310/MAX4313  
ALL-HOSTILE CROSSTALK vs. FREQUENCY**



**MAX4312/MAX4315  
ALL-HOSTILE CROSSTALK vs. FREQUENCY**

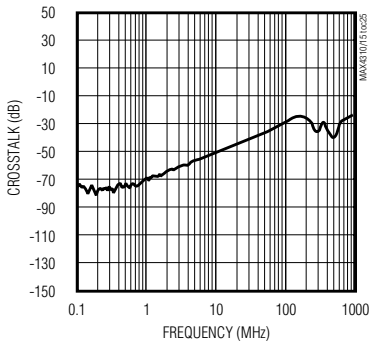

**MAX4311/MAX4314  
ALL-HOSTILE CROSSTALK vs. FREQUENCY**

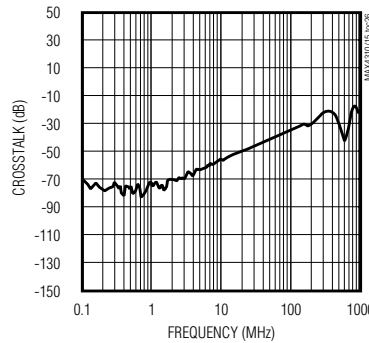

**OUTPUT IMPEDANCE vs. FREQUENCY**



**VOLTAGE-NOISE DENSITY vs. FREQUENCY (INPUT REFERRED)**

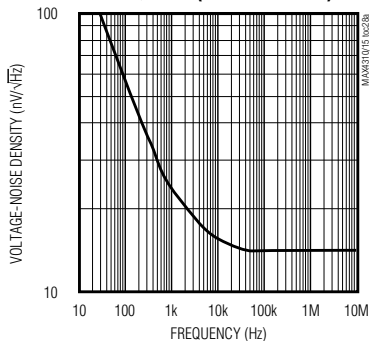

**CURRENT-NOISE DENSITY vs. FREQUENCY (INPUT REFERRED)**

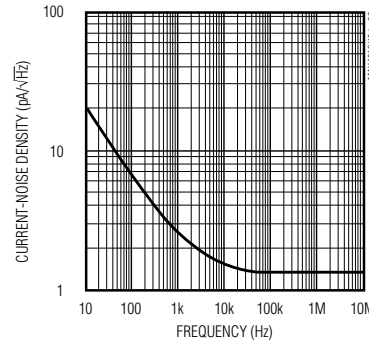

**MAX4310  
LARGE-SIGNAL PULSE RESPONSE**





# High-Speed, Low-Power, Single-Supply Multichannel, Video Multiplexer-Amplifiers

## Typical Operating Characteristics (continued)

( $V_{CC} = +5V$ ,  $V_{EE} = 0V$ ,  $\overline{SHDN} \geq 4V$ ,  $R_L = 150\Omega$  to  $V_{CC}/2$ ,  $V_{CM} = 1.5V$ ,  $AV_{CL} = +1V/V$  (MAX4310/MAX4311/MAX4312),  $AV_{CL} = +2V/V$  (MAX4313/MAX4314/MAX4315),  $T_A = +25^\circ C$ , unless otherwise noted.)

**MAX4311  
LARGE-SIGNAL PULSE RESPONSE**



**MAX4312  
LARGE-SIGNAL PULSE RESPONSE**



**MAX4313  
LARGE-SIGNAL PULSE RESPONSE**



**MAX4314  
LARGE-SIGNAL PULSE RESPONSE**



**MAX4315  
LARGE-SIGNAL PULSE RESPONSE**



**MAX4310  
SMALL-SIGNAL PULSE RESPONSE**



**MAX4311  
SMALL-SIGNAL PULSE RESPONSE**



**MAX4312  
SMALL-SIGNAL PULSE RESPONSE**



**MAX4313  
SMALL-SIGNAL PULSE RESPONSE**



**MAX4310-MAX4315**

# High-Speed, Low-Power, Single-Supply Multichannel, Video Multiplexer-Amplifiers

## Typical Operating Characteristics (continued)

( $V_{CC} = +5V$ ,  $V_{EE} = 0V$ ,  $\overline{SHDN} \geq 4V$ ,  $R_L = 150\Omega$  to  $V_{CC}/2$ ,  $V_{CM} = 1.5V$ ,  $A_{VCL} = +1V/V$  (MAX4310/MAX4311/MAX4312),  $A_{VCL} = +2V/V$  (MAX4313/MAX4314/MAX4315),  $T_A = +25^\circ C$ , unless otherwise noted.)

**MAX4314  
SMALL-SIGNAL PULSE RESPONSE**



**MAX4315  
SMALL-SIGNAL PULSE RESPONSE**



**MAX4310  
SMALL-SIGNAL PULSE RESPONSE  
( $C_L = 10pF$ )**



**MAX4310  
SMALL-SIGNAL PULSE RESPONSE  
( $C_L = 22pF$ )**



**MAX4313  
SMALL-SIGNAL PULSE RESPONSE  
( $C_L = 10pF$ )**



**MAX4313  
SMALL-SIGNAL PULSE RESPONSE  
( $C_L = 22pF$ )**



**CHANNEL-SWITCHING TRANSIENT**



**SHUTDOWN RESPONSE TIME**



# High-Speed, Low-Power, Single-Supply Multichannel, Video Multiplexer-Amplifiers

## Pin Description

PIN								NAME	FUNCTION
MAX4310 SO/μMAX	MAX4311		MAX4312 SO/QSOP	MAX4313 SO/μMAX	MAX4314		MAX4315 SO/QSOP		
	SO	QSOP			SO	QSOP			
1	2	2	3	1	2	2	3	A0	Channel Address Logic Input 0
—	1	1	2	—	1	1	2	A1	Channel Address Logic Input 1
—	—	—	1	—	—	—	1	A2	Channel Address Logic Input 2
2	12	14	14	2	12	14	14	$\overline{\text{SHDN}}$	Shutdown Input
3	4	4	4	3	4	4	4	V <sub>CC</sub>	Positive Power Supply
4	5	5	5	4	5	5	5	IN0	Amplifier Input 0
5	7	7	6	5	7	7	6	IN1	Amplifier Input 1
—	8	10	7	—	8	10	7	IN2	Amplifier Input 2
—	10	12	8	—	10	12	8	IN3	Amplifier Input 3
—	—	—	9	—	—	—	9	IN4	Amplifier Input 4
—	—	—	10	—	—	—	10	IN5	Amplifier Input 5
—	—	—	11	—	—	—	11	IN6	Amplifier Input 6
—	—	—	12	—	—	—	12	IN7	Amplifier Input 7
6	11	13	13	6	11	13	13	V <sub>EE</sub>	Negative Power Supply. Ground for single-supply operation.
7	13	15	15	—	—	—	—	FB	Amplifier Feedback Input
—	—	—	—	7	13	15	15	GND	Ground
8	14	16	16	8	14	16	16	OUT	Amplifier Output
—	3, 6, 9	3, 6, 8, 9, 11	—	—	3, 6, 9	3, 6, 8, 9, 11	—	N.C.	Not connected. Tie to ground plane for optimal performance.

MAX4310-MAX4315

# High-Speed, Low-Power, Single-Supply Multichannel, Video Multiplexer-Amplifiers

## Detailed Description

The MAX4310/MAX4311/MAX4312 combine 2-channel, 4-channel, or 8-channel multiplexers, respectively, with an adjustable-gain output amplifier optimized for closed-loop gains of +1V/V (0dB) or greater. The MAX4313/MAX4314/MAX4315 combine 2-channel, 4-channel, or 8-channel multiplexers, respectively, with a +2V/V (6dB) fixed-gain amplifier, optimized for driving back-terminated cables. These devices operate from a single supply voltage of +4V to +10.5V, or from dual supplies of ±2V to ±5.25V. The outputs may be placed in a high-impedance state and the supply current minimized by forcing the SHDN pin low. The input multiplexers feature short 40ns channel-switching times and small 10mVp-p switching transients. The input capacitance remains constant at 1pF whether the channel is on or off, providing a predictable input impedance to the signal source. These devices feature single-supply, rail-to-rail, voltage-feedback output amplifiers that achieve up to 540V/μs slew rates and up to 345MHz -3dB bandwidths. These devices also feature excellent harmonic distortion and differential gain/phase performance.

## Applications Information

### Rail-to-Rail Outputs, Ground-Sensing Input

The input common-mode range extends from the negative supply rail to  $V_{CC} - 2.7V$  with excellent common-mode rejection. Beyond this range, multiplexer switching times may increase and the amplifier output is a nonlinear function of the input, but does not undergo phase reversal or latchup.

The output swings to within 250mV of  $V_{CC}$  and 40mV of  $V_{EE}$  with a 10kΩ load. With a 150Ω load to ground, the output swings from 30mV above  $V_{EE}$  to within 730mV of



Figure 1. MAX4310 Noninverting Gain Configuration

the supply rail. Local feedback around the output stage ensures low open-loop output impedance to reduce gain sensitivity to load variations. This feedback also produces demand-driven bias current to the output transistors for ±95mA drive capability while constraining total supply current to only 6.1mA.

### Feedback and Gain Resistor Selection (MAX4310/MAX4311/MAX4312)

Select the MAX4310/MAX4311/MAX4312 gain-setting feedback ( $R_F$ ) and input ( $R_G$ ) resistors to fit your application. Large resistor values increase voltage noise and interact with the amplifier's input and PC board capacitance. This can generate undesirable poles and zeros, and can decrease bandwidth or cause oscillations. For example, a noninverting gain of +2V/V configuration ( $R_F = R_G$ ) using 1kΩ resistors, combined with 2pF of input capacitance and 1pF of PC board capacitance, causes a pole at 159MHz. Since this pole is within the amplifier bandwidth, it jeopardizes stability. Reducing the 1kΩ resistors to 100Ω extends the pole frequency to 1.59GHz, but could limit output swing by adding 200Ω in parallel with the amplifier's load resistor.

Table 1 shows suggested  $R_F$  and  $R_G$  values for the MAX4310/MAX4311/MAX4312 when operating in the non-inverting configuration (shown in Figure 1). These values provide optimal AC response using surface-mount resistors and good layout techniques, as discussed in the *Layout and Power-Supply Bypassing* section.

Stray capacitance at the FB pin causes feedback resistor decoupling and produces peaking in the frequency-response curve. Keep the capacitance at FB as low as possible by using surface-mount resistors and by avoiding the use of a ground plane beneath or beside these resistors and the FB pin. Some capacitance is unavoidable; if necessary, its effects can be neutralized by adjusting  $R_F$ . Use 1% resistors to maintain consistency over a wide range of production lots.

Table 1. Bandwidth and Gain with Suggested Gain-Setting resistors (MAX4310/MAX4311/MAX4312)

GAIN (V/V)	GAIN (d B)	$R_F$ (Ω)	$R_G$ (Ω)	-3dB BW (MHz)	0.1dB BW (MHz)
1	0	0	∞	280	60
2	6	500	500	80	30
5	14	500	120	20	4
10	20	500	56	10	2

# High-Speed, Low-Power, Single-Supply Multichannel, Video Multiplexer-Amplifiers

MAX4310-MAX4315



Figure 2. Logic-Low Input Current vs.  $V_{IL}$  ( $\overline{SHDN}$ , A0, A1, A2)



Figure 4. Logic-Low Input Current vs.  $V_{IL}$  with 10k $\Omega$  Series Resistor



Figure 3. Circuit to Reduce Logic-Low Input Current

## Low-Power Shutdown Mode

All parts feature a low-power shutdown mode that is activated by driving the  $\overline{SHDN}$  input low. Placing the amplifier in shutdown mode reduces the quiescent supply current to 560 $\mu$ A and places the output into a high-impedance state, typically 35k $\Omega$ . By tying the outputs of several devices together and disabling all but one of the paralleled amplifiers' outputs, multiple devices may be paralleled to construct larger switch matrices.

For MAX4310/MAX4311/MAX4312 application circuits operating with a closed-loop gain of +2V/V or greater, consider the external-feedback network impedance of all devices used in the mux application when calculating the total load on the output amplifier of the active device. The MAX4313/MAX4314/MAX4315 have a fixed gain of +2V/V that is internally set with two 500 $\Omega$  thin-film resistors. The impedance of the internal feedback resistors must be taken into account when operating multiple MAX4313/MAX4314/MAX4315s in large multiplexer applications. For normal operation, drive  $\overline{SHDN}$  high. If the shutdown function is not used, connect  $\overline{SHDN}$  to  $V_{CC}$ .

## Layout and Power-Supply Bypassing

The MAX4310-MAX4315 have very high bandwidths and consequently require careful board layout, including the possible use of constant-impedance microstrip or stripline techniques.

To realize the full AC performance of these high-speed amplifiers, pay careful attention to power-supply bypassing and board layout. The PC board should have at least two layers: a signal and power layer on one side, and a large, low-impedance ground plane on the other side. The ground plane should be as free of voids as possible, with one exception: the feedback (FB) should have as low a capacitance to ground as possible. Therefore, layers that do not incorporate a signal or power trace should not have a ground plane.

Whether or not a constant-impedance board is used, it is best to observe the following guidelines when designing the board:

- 1) Do not use wire-wrapped boards (they are too inductive) or breadboards (they are too capacitive).
- 2) Do not use IC sockets; they increase parasitic capacitance and inductance.
- 3) Keep signal lines as short and straight as possible. Do not make 90° turns; round all corners.
- 4) Observe high-frequency bypassing techniques to maintain the amplifier's accuracy and stability.
- 5) Use surface-mount components. They generally have shorter bodies and lower parasitic reactance, yielding better high-frequency performance than through-hole components.

# High-Speed, Low-Power, Single-Supply Multichannel, Video Multiplexer-Amplifiers



Figure 5. Video Line Driver



Figure 8. Optimal Isolation Resistance vs. Capacitive Load

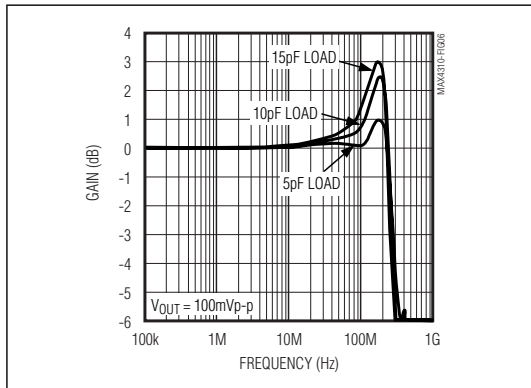

Figure 6. Small-Signal Gain vs. Frequency with a Capacitive Load and No-Isolation Resistor

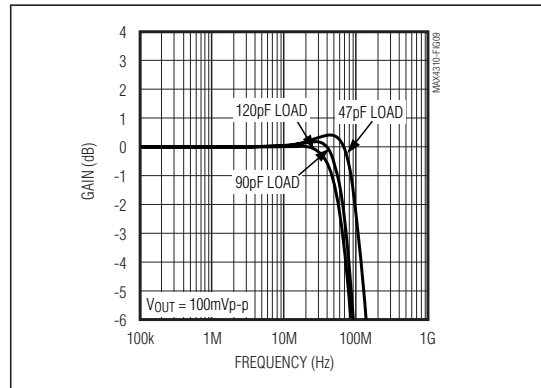

Figure 9. Small-Signal Gain vs. Frequency with a Capacitive Load and 27Ω No-Isolation Resistor

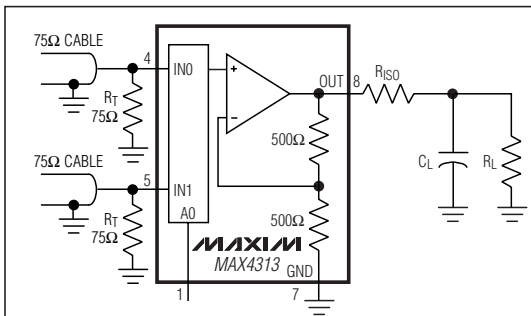

Figure 7. Using an Isolation Resistor ( $R_{iso}$ ) for High-Capacitive Loads

The bypass capacitors should include a 100nF, ceramic surface-mount capacitor between each supply pin and the ground plane, located as close to the package as possible. Optionally, place a 10μF tantalum capacitor at the power-supply pin's point of entry to the PC board to ensure the integrity of incoming supplies. The power-supply trace should lead directly from the tantalum capacitor to the VCC and VEE pins. To minimize parasitic inductance, keep PC traces short and use surface-mount components. If input termination resistors and output back-termination resistors are used, they should be surface-mount types, and should be placed as close to the IC pins as possible.

# High-Speed, Low-Power, Single-Supply Multichannel, Video Multiplexer-Amplifiers



Figure 10. High-Speed EV Board Layout—Component Side



Figure 11. High-Speed EV Board Layout—Solder Side

### Video Line Driver

The MAX4310-MAX4315 are well-suited to drive coaxial transmission lines when the cable is terminated at both ends, as shown in Figure 5. Cable frequency response can cause variations in the signal's flatness.

### Driving Capacitive Loads

A correctly terminated transmission line is purely resistive and presents no capacitive load to the amplifier. Reactive loads decrease phase margin and may produce excessive ringing and oscillation (see *Typical Operating Characteristics*).

Table 2. Input Control Logic

MAX4310/MAX4313				
SHDN	A2	A1	A0	CHANNEL SELECTED
0	—	—	X	None, High-Z Output
1	—	—	0	0
1	—	—	1	1
MAX4311/MAX4314				
SHDN	A2	A1	A0	CHANNEL SELECTED
0	—	X	X	None, High-Z Output
1	—	0	0	0
1	—	0	1	1
1	—	1	0	2
1	—	1	1	3
MAX4312/MAX4315				
SHDN	A2	A1	A0	CHANNEL SELECTED
0	X	X	X	None, High-Z Output
1	0	0	0	0
1	0	0	1	1
1	0	1	0	2
1	0	1	1	3
1	1	0	0	4
1	1	0	1	5
1	1	1	0	6
1	1	1	1	7

Another concern when driving capacitive loads originates from the amplifier's output impedance, which appears inductive at high frequencies. This inductance forms an L-C resonant circuit with the capacitive load, which causes peaking in the frequency response and degrades the amplifier's phase margin.

Although the MAX4310-MAX4315 are optimized for AC performance and are not designed to drive highly capacitive loads, they are capable of driving up to 20pF without oscillations. However, some peaking may occur in the frequency domain (Figure 6). To drive larger capacitive loads or to reduce ringing, add an isolation resistor between the amplifier's output and the load (Figure 7).

The value of RISO depends on the circuit's gain and the capacitive load (Figure 8). Figure 9 shows the MAX4310-MAX4315 frequency response with the isolation resistor and a capacitive load. With higher capacitive values, bandwidth is dominated by the RC network formed by RISO and CL; the bandwidth of the amplifier itself is much higher. Also note that the isolation resistor forms a divider that decreases the voltage delivered to the load.

# High-Speed, Low-Power, Single-Supply Multichannel, Video Multiplexer-Amplifiers

## Digital Interface

The multiplexer architecture of the MAX4310–MAX4315 ensures that no two input channels are ever connected together. Channel selection is accomplished by applying a binary code to channel address inputs. The address decoder selects input channels, as shown in Table 2. All digital inputs are CMOS compatible.

## High-Speed Evaluation Board

Figures 10 and 11 show the evaluation board and present a suggested layout for the circuits. This board was developed using the techniques described in the *Layout and Power-Supply Bypassing* section. The smallest available surface-mount resistors were used

for feedback and back-termination to minimize their distance from the part, reducing the capacitance associated with longer lead lengths.

SMA connectors were used for best high-frequency performance. Inputs and outputs do not match a 75Ω line, but this does not affect performance since distances are extremely short. However, in applications that require lead lengths greater than one-quarter of the wavelength of the highest frequency of interest, use constant-impedance traces. Fully assembled evaluation boards are available for the MAX4313 in an SO package.

## Typical Operating Circuit



## Chip Information

TRANSISTOR COUNT: 156

## Package Information

For the latest package outline information, go to [www.maxim-ic.com/packages](http://www.maxim-ic.com/packages).

PACKAGE TYPE	PACKAGE CODE	DOCUMENT NO.
8 SO	S8-4	<a href="#">21-0041</a>
8 µMAX	U8-1	<a href="#">21-0036</a>
14 Narrow SO	S14-1	<a href="#">21-0041</a>
16 Narrow SO	S16-1	<a href="#">21-0041</a>
16 QSOP	E16-1	<a href="#">21-0055</a>



# High-Speed, Low-Power, Single-Supply Multichannel, Video Multiplexer-Amplifiers

## Pin Configurations

MAX4310-MAX4315

TOP VIEW

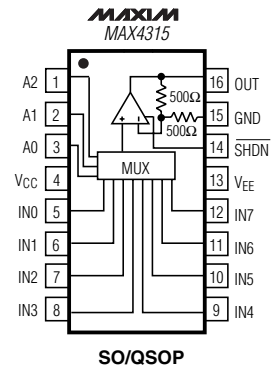
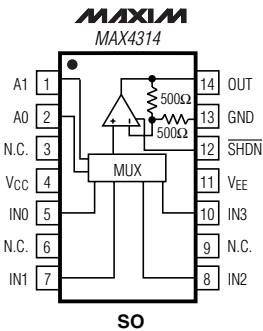

N.C. = NOT INTERNALLY CONNECTED. TIE TO GROUND PLANE FOR OPTIMAL PERFORMANCE.

# High-Speed, Low-Power, Single-Supply Multichannel, Video Multiplexer-Amplifiers

## Revision History

REVISION NUMBER	REVISION DATE	DESCRIPTION	PAGES CHANGED
0	7/98	Initial release	—
1	4/99	Added new parts to data sheet.	1-20
2	12/02	Corrected MAX4314 Pin Configuration.	17
3	3/08	Updated <i>Typical Operating Characteristics</i> .	8

Maxim cannot assume responsibility for use of any circuitry other than circuitry entirely embodied in a Maxim product. No circuit patent licenses are implied. Maxim reserves the right to change the circuitry and specifications without notice at any time.

18 \_\_\_\_\_ **Maxim Integrated Products, 120 San Gabriel Drive, Sunnyvale, CA 94086 408-737-7600**