

UNCONTROLLED DOCUMENT

PART NUMBER		REV.
SML-LX1206AW-TR		C
REV.	E.C.N. NUMBER AND REVISION COMMENTS	DATE
A	E.C.N. #10814.	12.3.01
B	E.C.N. #10967.	3.14.03
C	E.C.N. #11148.	1.20.05

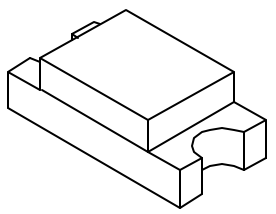

LEAD FREE REFLOW PROFILE

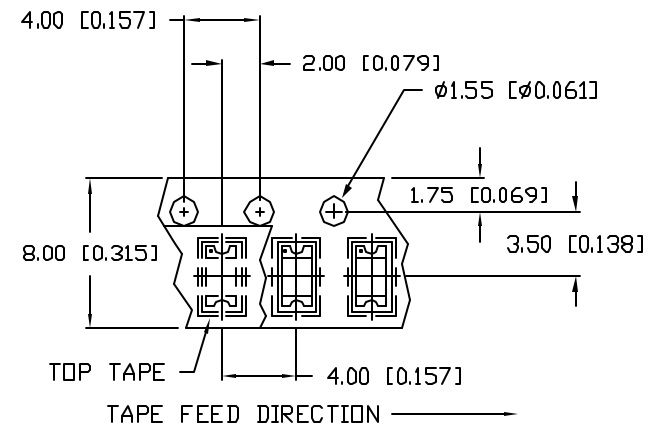
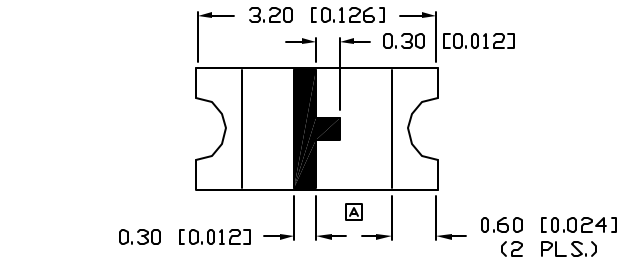
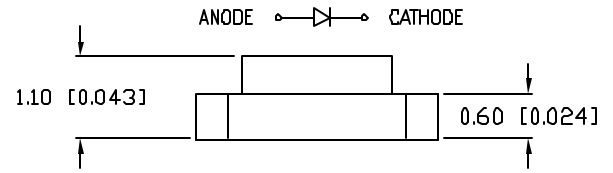
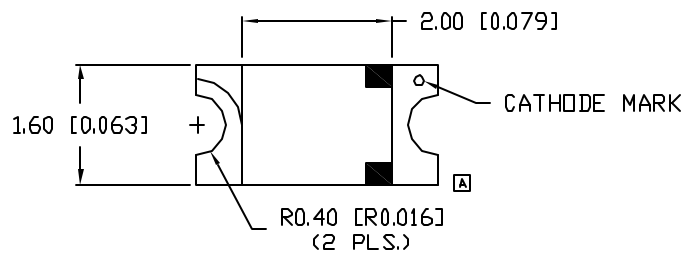
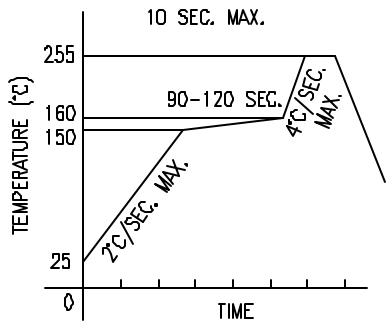

TOTAL TIME ABOVE 220°C IS 60 SECONDS MAX.

RECOMMENDED SOLDER PAD LAYOUT

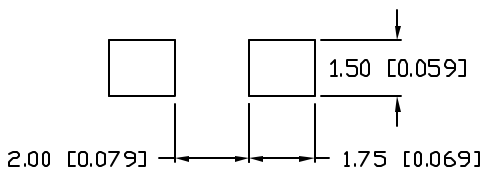

ELECTRO-OPTICAL CHARACTERISTICS  $T_A=25^\circ\text{C}$   $I_f=20\text{mA}$

PARAMETER	MIN	TYP	MAX	UNITS	TEST COND
PEAK WAVELENGTH		610		nm	
FORWARD VOLTAGE		2.0	2.6	$V_f$	
REVERSE VOLTAGE	5.0			$V_r$	$I_f=100\mu\text{A}$
AXIAL INTENSITY		6		mcad	$I_f=20\text{mA}$
VIEWING ANGLE		160		2x theta	
EMITTED COLOR:	AMBER				
EPOXY LENS FINISH:	MILKY WHITE DIFFUSED				

LIMITS OF SAFE OPERATION AT 25°C

PARAMETER	MAX	UNITS
PEAK FORWARD CURRENT*	100	mA
STEADY CURRENT	25	mA
POWER DISSIPATION	65	mW
DERATE FROM 25°C	-1.2	mW/°C
OPERATING TEMP.	-25 TO +85	°C
STORAGE TEMP.	-30 TO +85	°C

NOTES:

1. THE POLARITY MARK IS ORIENTED TOWARDS THE TAPE SPROCKET HOLE.

CAUTION: MOISTURE SENSITIVE DEVICE  
PER JEDEC LEVEL 4 STANDARDS

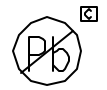

\*UNLESS OTHERWISE SPECIFIED TOLERANCES PER DECIMAL PRECISION ARE: X=±1 (±0.039), XX=±0.5 (±0.020), XXX=±0.25 (±0.010), XXXX=±0.127 (±0.005). LEAD SIZE=±0.05 (0.002), LEAD LENGTH=±0.75 (±0.030), MIN= +DECIMAL PRECISION -0.00, MAX.= +0.00 -DECIMAL PRECISION

UNCONTROLLED DOCUMENT

REV.	PART NUMBER
C	SML-LX1206AW-TR
3.2mm x 1.6mm PCB SURFACE MOUNT LED, 610nm AMBER LED, MILKY WHITE DIFFUSED LENS, TAPE AND REEL.	

**CONFIDENTIAL INFORMATION**  
THE INFORMATION CONTAINED IN THIS DOCUMENT IS THE PROPERTY OF LUMEX INC. EXCEPT AS SPECIFICALLY AUTHORIZED IN WRITING BY LUMEX INC., THE HOLDER OF THIS DOCUMENT SHALL KEEP ALL INFORMATION CONTAINED HEREIN CONFIDENTIAL AND SHALL PROTECT SAME IN WHOLE OR IN PART FROM DISCLOSURE AND DISSEMINATION TO ALL THIRD PARTIES.

**RELIABILITY NOTE**  
OUR MANY YEARS OF EXPERIENCE DATA ACCUMULATION INDICATE THAT SOLDER HEAT IS A MAJOR CAUSE OF EARLY AND FUTURE FAILURE. PLEASE PAY ATTENTION TO YOUR SOLDERING PROCESS.

<b>LUMEX</b> 3000 W. HENRY ROAD MILWAUKEE, WI 53227-1000		290 E. HELEN ROAD PALATINE, IL 60067-6976 PHONE: +1.847.359.2790 US WEB: www.lumex.com TW WEB: www.lumex.com.tw	
DRAWN BY:	CHECKED BY:	APPROVED BY:	DATE:
CT			6.14.01
		PAGE:	1 OF 1
		SCALE:	N/A