

SJxx25xx Series



Schematic Symbol



Description

This SJxx25xx high temperature SCR series is ideal for uni-directional switch applications such as phase control in heating, motor speed controls, converters/rectifiers and inrush current controllers. These SCRs have a low gate current trigger level of 6mA, 10mA or 35mA maximum at approximately 1.5V

Features & Benefits

- Halogen free and RoHS compliant
- Surge capability up to 350 A at 60 Hz half cycle
- 150°C maximum junction temperature

Applications

Typical applications include AC Generator (ACG) rectifiers, battery voltage regulators, generic converters, inrush current controller in various AC to DC applications and soft starter for low power AC motor. Additional applications include controls for power tools, home/brown good and white goods appliances.

Isolated packages offered for ease of heat sinking.

Agency Approval

Agency	Agency File Number
	L Packages: E71639

Main Features

Symbol	Value	Unit
$I_{T(RMS)}$	25	A
V_{DRM}/V_{RRM}	400 or 600	V
I_{GT}	6, 10, to 35	mA

Absolute Maximum Ratings

Symbol	Parameter	Test Conditions	Value	Unit
V_{DRM}/V_{RSM}	Peak non-repetitive blocking voltage	$P_w=100 \mu s$	$V_{DRM}/V_{RRM}+100$	V
$I_{T(RMS)}$	RMS on-state current	SJxx25Lx $T_c = 100^\circ C$	25	A
		SJxx25Rx SJxx25Nx $T_c = 125^\circ C$		
		SJxx25Lx SJxx25Rx SJxx25Nx $T_c = 125^\circ C$		
$I_{T(AV)}$	Average on-state current	SJxx25Lx $T_c = 100^\circ C$	16	A
		SJxx25Rx SJxx25Nx $T_c = 125^\circ C$		
I_{TSM}	Peak non-repetitive surge current	single half cycle; $f = 50Hz$; T_j (initial) = $25^\circ C$	300	A
		single half cycle; $f = 60Hz$; T_j (initial) = $25^\circ C$	350	
I^2t	I^2t Value for fusing	$t_p = 8.3 ms$	510	A^2s
di/dt	Critical rate of rise of on-state current	$f = 60Hz ; T_j = 150^\circ C$	125	$A/\mu s$
I_{GM}	Peak gate current	$T_j = 150^\circ C$	3	A
$P_{G(AV)}$	Average gate power dissipation	$T_j = 150^\circ C$	0.6	W
T_{stg}	Storage temperature range		-40 to 150	$^\circ C$
T_j	Operating junction temperature range		-40 to 150	$^\circ C$

Note: xx=voltage/10, x=sensitivity

SJxx25xx Series

Electrical Characteristics ($T_J = 25^\circ\text{C}$, unless otherwise specified)

Symbol	Test Conditions		Value			Unit
			SJxx25x	SJxx25x1	SJxx25x2	
I_{GT}	$V_D = 12V$ $R_L = 60\ \Omega$	MAX.	35	6	10	mA
		MIN.	8	2	5	
V_{GT}	$V_D = 12V$ $R_L = 60\ \Omega$	MAX.	1.5			V
dv/dt	$V_D = 67\% V_{DRM}$; gate open; $T_J = 125^\circ\text{C}$	MIN.	800	70	500	V/ μs
	$V_D = 67\% V_{DRM}$; gate open; $T_J = 150^\circ\text{C}$		400	-	200	
V_{GD}	$V_D = V_{DRM}$ $R_L = 3.3\ \text{k}\Omega$ $T_J = 125^\circ\text{C}$	MIN.	0.2			V
I_H	$I_T = 400\text{mA}$ (initial)	MAX.	75	15	35	mA
t_q	$I_T = 2A$; $t_p = 50\mu\text{s}$; $dv/dt = 5V/\mu\text{s}$; $di/dt = 30A/\mu\text{s}$	MAX.	40			μs
t_{gt}	$I_G = 2 \times I_{GT}$ $PW = 15\mu\text{s}$ $I_T = 50A$	TYP.	2			μs

Note: xx=voltage/10, x=package

Static Characteristics

Symbol	Test Conditions	Value	Unit	
V_{TM}	Component $I_T = 50A$; $t_p = 380\ \mu\text{s}$	MAX.	1.6	V
I_{DRM} / I_{RRM}	$V_{DRM} = V_{RRM}$	$T_J = 25^\circ\text{C}$	10	μA
		$T_J = 125^\circ\text{C}$	1000	
		$T_J = 150^\circ\text{C}$	3000	

Thermal Resistances

Symbol	Parameter	Value	Unit	
$R_{\theta(JC)}$	Junction to case (AC)	SJxx25Rx SJxx25Nx	1.0	$^\circ\text{C/W}$
		SJxx25Lx	2.3	

Note: xx=voltage/10, x=sensitivity

Figure 1: Normalized DC Gate Trigger Current vs. Junction Temperature



Figure 2: Normalized DC Gate Trigger Voltage vs. Junction Temperature

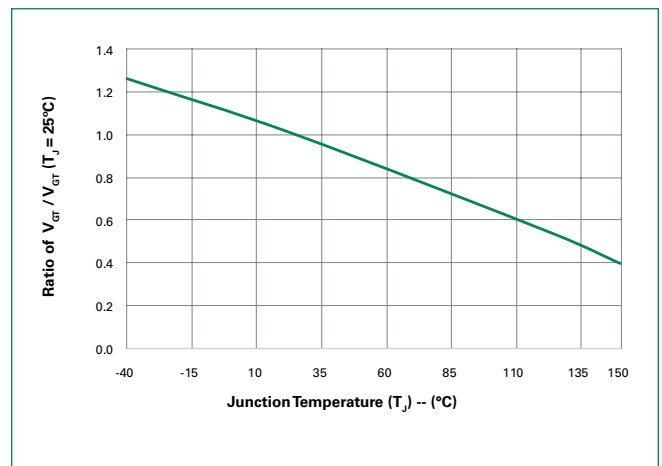

Figure 3: Normalized DC Holding Current vs. Junction Temperature

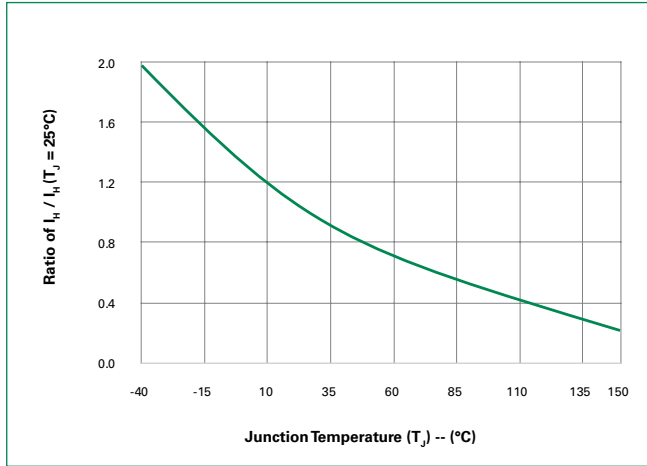

Figure 4: On-State Current vs. On-State Voltage (Typical)

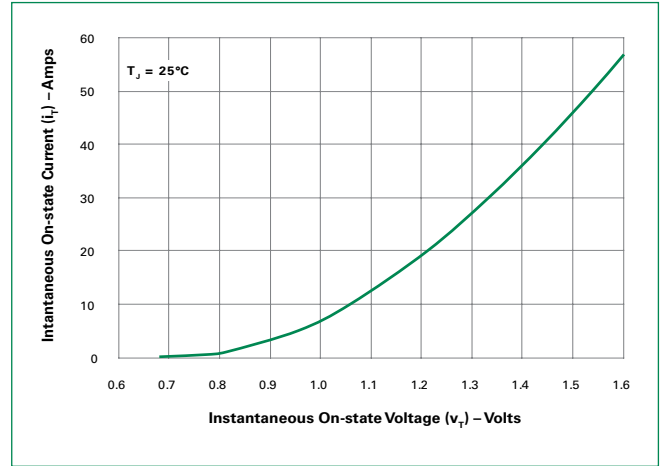

Figure 5: Power Dissipation (Typical) vs. RMS On-State Current

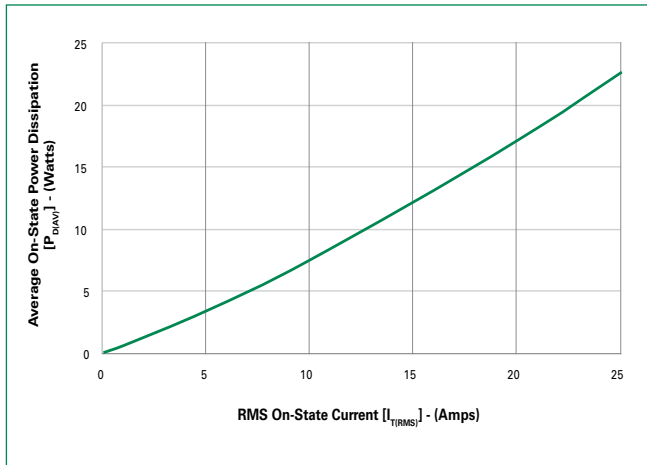

Figure 6: Maximum Allowable Case Temperature vs. RMS On-State Current

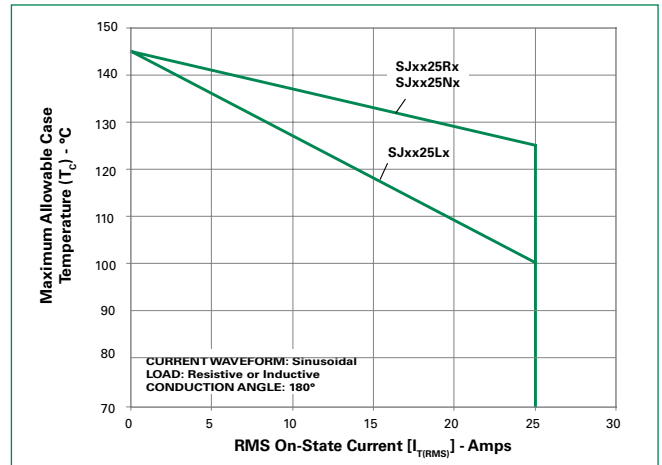

Figure 7: Maximum Allowable Case Temperature vs. Average On-State Current

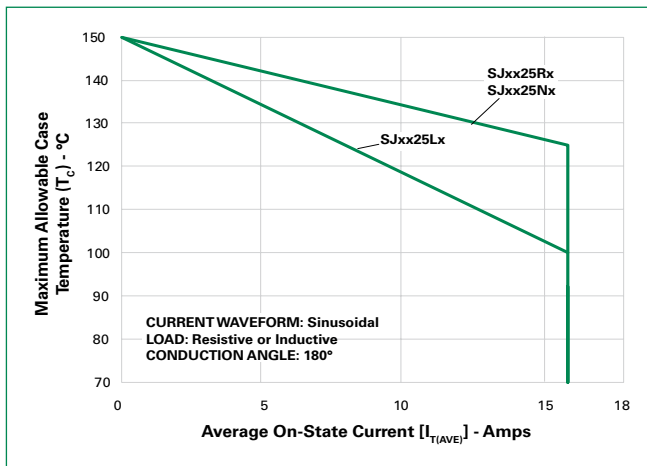

Figure 8: Peak Capacitor Discharge Current

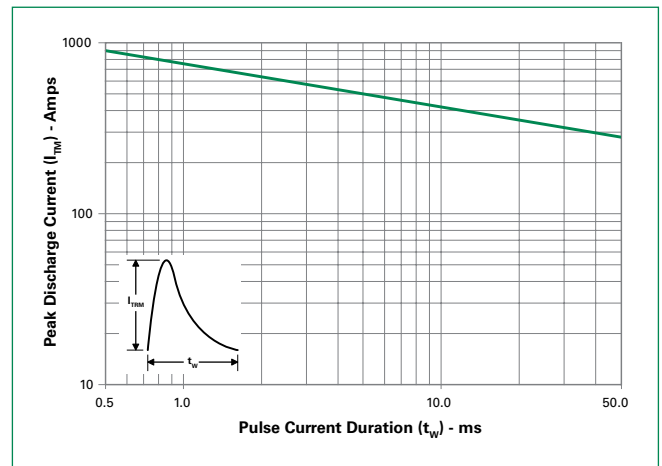

Figure 9: Peak Capacitor Discharge Current Derating



Figure 10: Surge Peak On-State Current vs. Number of Cycles



SUPPLY FREQUENCY: 60 Hz Sinusoidal
LOAD: Resistive
RMS On-State Current: [I_{T(RMS)}]: Maximum Rated Value at Specified Case Temperature

- Notes:
1. Gate control may be lost during and immediately following surge current interval.
 2. Overload may not be repeated until junction temperature has returned to steady-state rated value.

Soldering Parameters

Reflow Condition		Pb – Free assembly
Pre Heat	- Temperature Min ($T_{s(min)}$)	150°C
	- Temperature Max ($T_{s(max)}$)	200°C
	- Time (min to max) (t_s)	60 – 180 secs
Average ramp up rate (Liquidus Temp) (T_L) to peak		5°C/second max
$T_{s(max)}$ to T_L - Ramp-up Rate		5°C/second max
Reflow	- Temperature (T_L) (Liquidus)	217°C
	- Time (t_L)	60 – 150 seconds
Peak Temperature (T_p)		260 ^{+0/-5} °C
Time within 5°C of actual peak Temperature (t_p)		20 – 40 seconds
Ramp-down Rate		5°C/second max
Time 25°C to peak Temperature (T_p)		8 minutes Max.
Do not exceed		280°C



Physical Specifications

Terminal Finish	100% Matte Tin-plated
Body Material	UL Recognized compound meeting flammability rating V-0.
Lead Material	Copper Alloy

Design Considerations

Careful selection of the correct component for the application's operating parameters and environment will go a long way toward extending the operating life of the Thyristor. Good design practice should limit the maximum continuous current through the main terminals to 75% of the component rating. Other ways to ensure long life for a power discrete semiconductor are proper heat sinking and selection of voltage ratings for worst case conditions. Overheating, overvoltage (including dv/dt), and surge currents are the main killers of semiconductors. Correct mounting, soldering, and forming of the leads also help protect against component damage.

Environmental Specifications

Test	Specifications and Conditions
AC Blocking	MIL-STD-750, M-1040, Cond A Applied Peak AC voltage @ 150°C for 1008 hours
Temperature Cycling	MIL-STD-750, M-1051, 100 cycles; -55°C to +150°C; 15-min dwell-time
Temperature/Humidity	EIA / JEDEC, JESD22-A101 1008 hours; 160V - DC: 85°C; 85% rel humidity
High Temp Storage	MIL-STD-750, M-1031, 1008 hours; 150°C
Low-Temp Storage	1008 hours; -40°C
Resistance to Solder Heat	MIL-STD-750 Method 2031
Solderability	ANSI/J-STD-002, category 3, Test A
Lead Bend	MIL-STD-750, M-2036 Cond E
Moisture Sensitivity Level	Level 1, JEDEC-J-STD-020D

Dimensions — TO-220AB (R-Package) — Non-Isolated Mounting Tab Common with Center Lead



Note: Maximum torque to be applied to mounting tab is 8 in-lbs. (0.904 Nm).

Dimension	Inches		Millimeters	
	Min	Max	Min	Max
A	0.380	0.420	9.65	10.67
B	0.105	0.115	2.67	2.92
C	0.230	0.250	5.84	6.35
D	0.590	0.620	14.99	15.75
E	0.142	0.147	3.61	3.73
F	0.110	0.130	2.79	3.30
G	0.540	0.575	13.72	14.61
H	0.025	0.035	0.64	0.89
J	0.195	0.205	4.95	5.21
K	0.095	0.105	2.41	2.67
L	0.060	0.075	1.52	1.91
M	0.085	0.095	2.16	2.41
N	0.018	0.024	0.46	0.61
O	0.178	0.188	4.52	4.78
P	0.045	0.060	1.14	1.52
R	0.038	0.048	0.97	1.22

Dimensions — TO-220AB (L-Package) — Isolated Mounting Tab

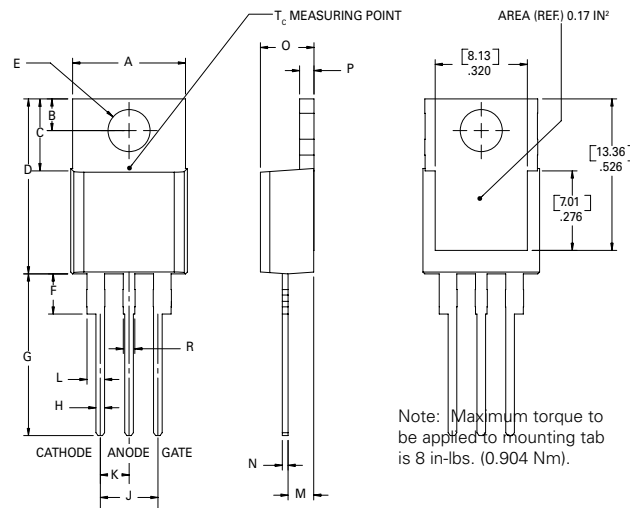

Note: Maximum torque to be applied to mounting tab is 8 in-lbs. (0.904 Nm).

Dimension	Inches		Millimeters	
	Min	Max	Min	Max
A	0.380	0.420	9.65	10.67
B	0.105	0.115	2.67	2.92
C	0.230	0.250	5.84	6.35
D	0.590	0.620	14.99	15.75
E	0.142	0.147	3.61	3.73
F	0.110	0.130	2.79	3.30
G	0.540	0.575	13.72	14.61
H	0.025	0.035	0.64	0.89
J	0.195	0.205	4.95	5.21
K	0.095	0.105	2.41	2.67
L	0.060	0.075	1.52	1.91
M	0.085	0.095	2.16	2.41
N	0.018	0.024	0.46	0.61
O	0.178	0.188	4.52	4.78
P	0.045	0.060	1.14	1.52
R	0.038	0.048	0.97	1.22

Dimensions –TO- 263AB (N-package) – D²-Pak Surface Mount



Dimension	Inches		Millimeters	
	Min	Max	Min	Max
A	0.360	0.370	9.14	9.40
B	0.380	0.420	9.65	10.67
C	0.178	0.188	4.52	4.78
D	0.025	0.035	0.64	0.89
E	0.045	0.060	1.14	1.52
F	0.060	0.075	1.52	1.91
G	0.095	0.105	2.41	2.67
H	0.092	0.102	2.34	2.59
J	0.018	0.024	0.46	0.61
K	0.090	0.110	2.29	2.79
S	0.590	0.625	14.99	15.88
V	0.035	0.045	0.89	1.14
U	0.002	0.010	0.05	0.25
W	0.040	0.070	1.016	1.78

Product Selector

Part Number	Voltage		Gate Sensitivity	Type	Package
	400V	600V			
SJxx25L	X	X	35mA	Standard SCR	TO-220L
SJxx25R	X	X	35mA	Standard SCR	TO-220R
SJxx25N	X	X	35mA	Standard SCR	TO-263
SJxx25L1	X	X	6mA	Standard SCR	TO-220L
SJxx25R1	X	X	6mA	Standard SCR	TO-220R
SJxx25N1	X	X	6mA	Standard SCR	TO-263
SJxx25L2	X	X	10mA	Standard SCR	TO-220L
SJxx25R2	X	X	10mA	Standard SCR	TO-220R
SJxx25N2	X	X	10mA	Standard SCR	TO-263

Note: xx = Voltage/10

Packing Options

Part Number	Marking	Weight	Packing Mode	Base Quantity
SJxx25LxTP	SJxx25Lx	2.2g	Tube	500 (50 per tube)
SJxx25RxTP	SJxx25Rx	2.2g	Tube	500 (50 per tube)
SJxx25NxTP	SJxx25Nx	1.6g	Tube	500 (50 per tube)
SJxx25NxRP	SJxx25Nx	1.6g	Embossed Carrier	500

Note: xx=voltage/10, x=sensitivity

TO-263 Embossed Carrier Reel Pack (RP) Specifications

Meets all EIA-481-2 Standards

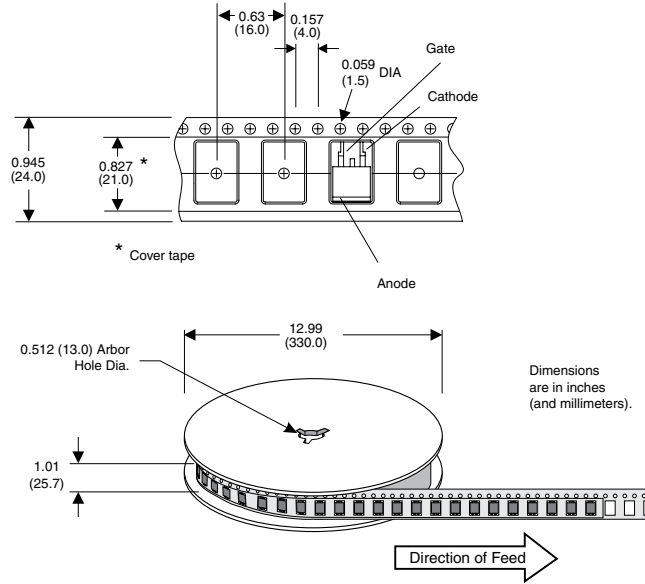

Part Numbering System

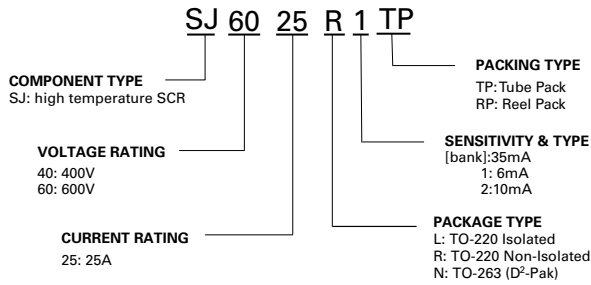

Part Marking System

TO-220 AB - (L and R Package)
TO-263 AB - (N Package)

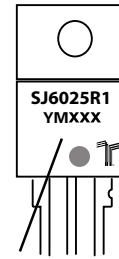

Date Code Marking
Y: Year Code
M: Month Code
XXX: Lot Trace Code

Disclaimer Notice - Information furnished is believed to be accurate and reliable. However, users should independently evaluate the suitability of and test each product selected for their own applications. Littelfuse products are not designed for, and may not be used in, all applications. Read complete Disclaimer Notice at <http://www.littelfuse.com/disclaimer-electronics>.