



opulent
americas

MOD BLOCK - 2X6 Performance

IP67-Rated Module built with Cree XHP35 LEDs

Primary Applications



High Mast	Canopy
Streetlight	Garage
Stadium	Portable
Architectural	High bay



Features and Benefits

- IP67 Protection – Self-contained module for outdoor applications or other difficult environments
- Optical Flexibility – a variety of off-the-shelf optical patterns are available
- Integrate Further – Easy to add multiple modules through our interlocking technology
- Easy Mounting – designed for quick mounting to a housing or bracket
- Performance – industry leading lumen density and lumens per pound
- Certifications – RoHS compliant
- Custom - private label or design changes available

Introducing the Opulent Americas IP67 rated LED heat sink module using Cree XHP35 Extreme High Power LEDs. This Opulent Americas module is engineered to bring high quality lighting systems to market faster with fewer LEDs, higher reliability, and a lower system cost. This module is a robust, flexible, and versatile building block for any number of lighting systems such as high bay, low bay, parking, and stadium lighting.

Interlocking Technology to Add More Modules



Last Modified: 11/16/17

RoHS 

MOD BLOCK - 2X6 Performance Specifications

Order Code Formatting

Series	-	Color Temperature	Color Rendering Index	-	Optic ⁽¹⁾	-	Cable Type	-	Internal Code
MP26T1 -C19 - XHP35 Mod Block		27 - 2700K	70 - 70 CRI		S		1 - Cable Pigtail		XX
		30 - 3000K	80 - 80 CRI		M		2 - Waterproof M15 Cable		
		40 - 4000K	90 - 90 CRI		W				
		50 - 5000K			WWW				
		57 - 5700K			T2				
					T3				
					T4				
					T5				
					DWC				

⁽¹⁾More optical patterns available upon request

*See Page 5 for Photometric Distributions

MOD BLOCK - 2X6 Performance Specifications

Ordering Information

Part Number	CCT	CRI	Binning	Forward Voltage (V)	Current (mA)	Typical Luminous Flux (lm)	Efficacy Nominal (lm/W)	Watts (W)
MP26T1-C19-5770-x	5700K	70	5-Step	46.1	1050	7512	155	48.4
	5700K	70	5-Step	46.7	1500	9856	140	70.0
	5700K	70	5-Step	47.2	2100	12286	124	99.2
MP26T1-C19-5070-x	5000K	70	5-Step	46.1	1050	7512	155	48.4
	5000K	70	5-Step	46.7	1500	9856	140	70.0
	5000K	70	5-Step	47.2	2100	12286	124	99.2
MP26T1-C19-4070-x	4000K	70	5-Step	46.1	1050	6980	144	48.4
	4000K	70	5-Step	46.7	1500	9158	130	70.0
	4000K	70	5-Step	47.2	2100	11416	115	99.2

Product performance based on 25°C ambient temperature.
All values shown above are typical.

Ratings

Parameter	Unit	Rating
Operating Temperature	°C	-40 to +40
Weight	G	1332

Performance Groups – Chromaticity

5-Step Binning					
CCT	Center Point		Major Axis	Minor Axis	Rotation Angle (°)
	X	Y	a	b	
5700K	0.3287	0.3417	0.01230	0.00600	72.0
5000K	0.3447	0.3553	0.01400	0.00520	65.0
4000K	0.3818	0.3797	0.001420	0.00550	61.5

MOD BLOCK - 2X6 Performance Specifications

Performance Characteristics

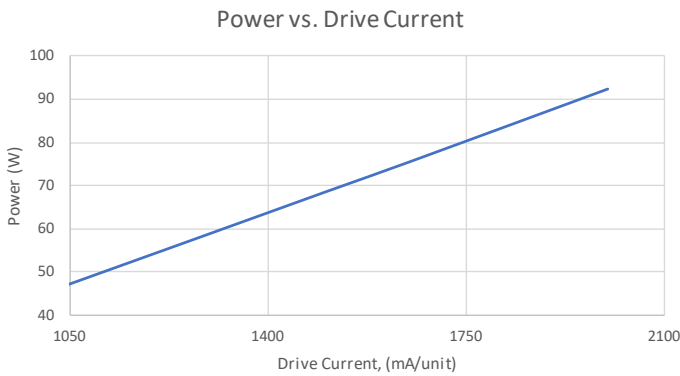
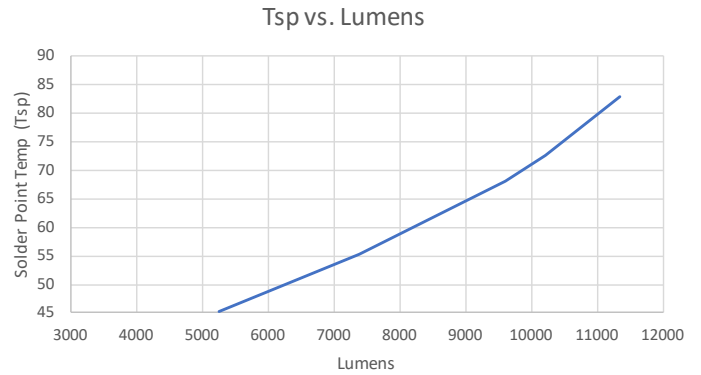
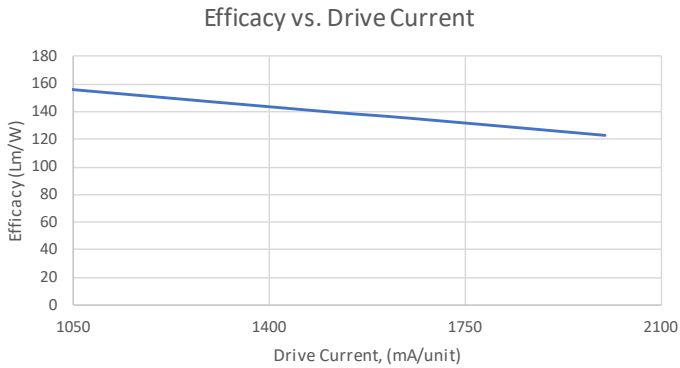
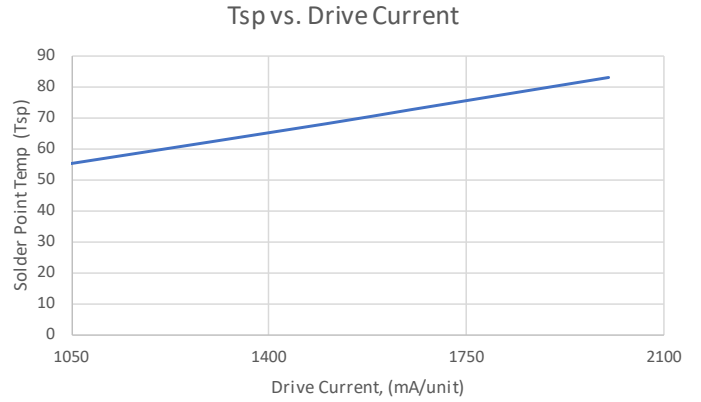
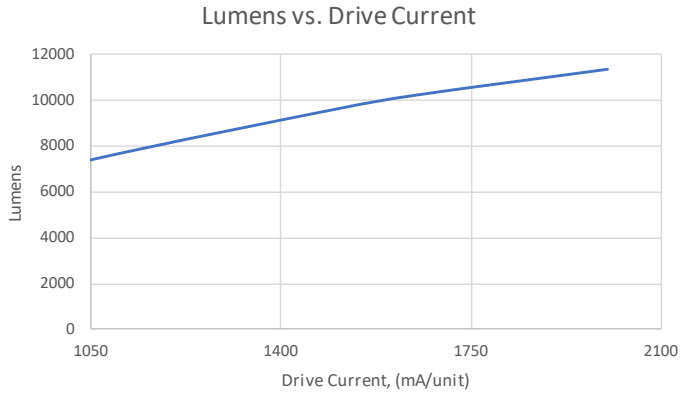

*Product performance based on 25°C ambient temperature

MOD BLOCK - 2X6 Performance Specifications

Photometric Distributions

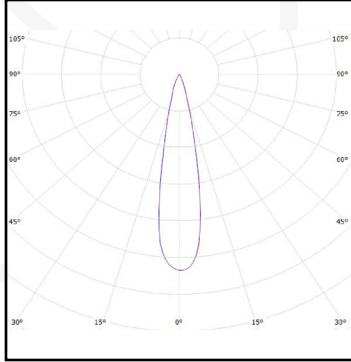

S - Spot
High Bay Series

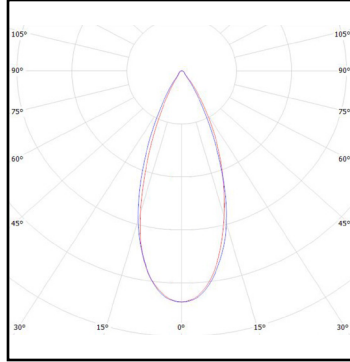

M - Medium
High Bay Series

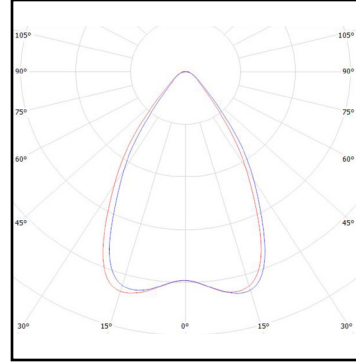

W - Wide
High Bay Series



WWW - Very Wide
High Bay Series



T2 - IESNA Type II
Roadway Series

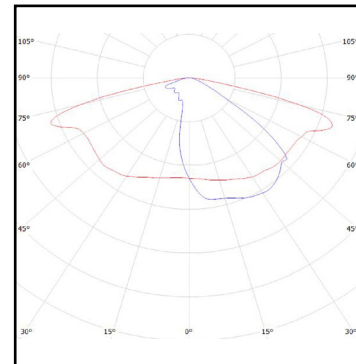

T3 - IESNA Type III
Roadway Series



T4 - IESNA Type IV
Roadway Series



T5 - IESNA Type V Square
Roadway Series

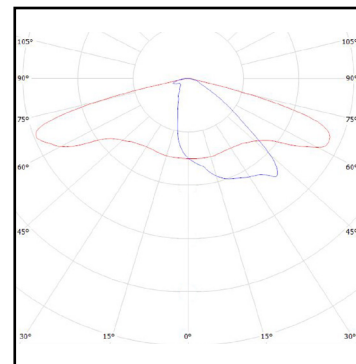

DWC - Universal Type III Medium
Roadway Series

MOD BLOCK - 2X6 Performance Specifications

Mechanical Dimensions

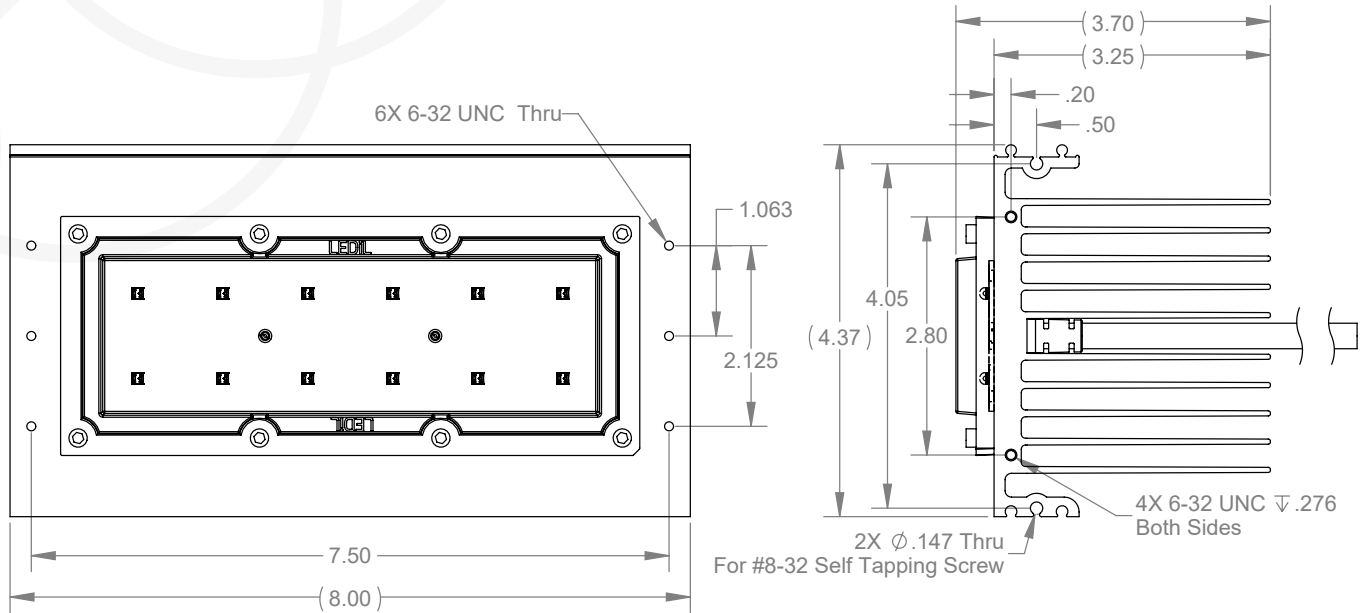

Cable Specs:

Cable Length: 20"

Cable OD: .288"

Wire Gauge: 18AWG

Wire Colors: White (+), Black (-)

Wire Voltage Rating: 300V

Wire Temperature Rating: 105°C