

ITEM	Q'TY	PART NUMBER	PART DESCRIPTION
1	1	ORFLP1-XXX	1mm Flexible Light Pipe ORCA Adapter w/ LED
2	1	LC-XX.X	Flexible Light Pipe Lens Cap Assembly, 3mm Round

REV.	DESCRIPTION	DATE	APPROVED
A	Engineering Release.	07/07/09	T. Y.
B	Updated Table For Length "X.X"	11/14/12	T. Y.

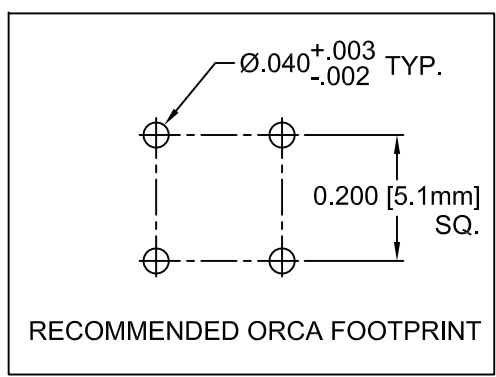
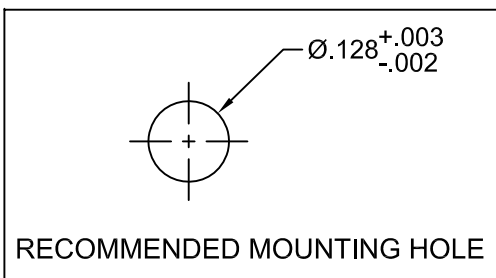
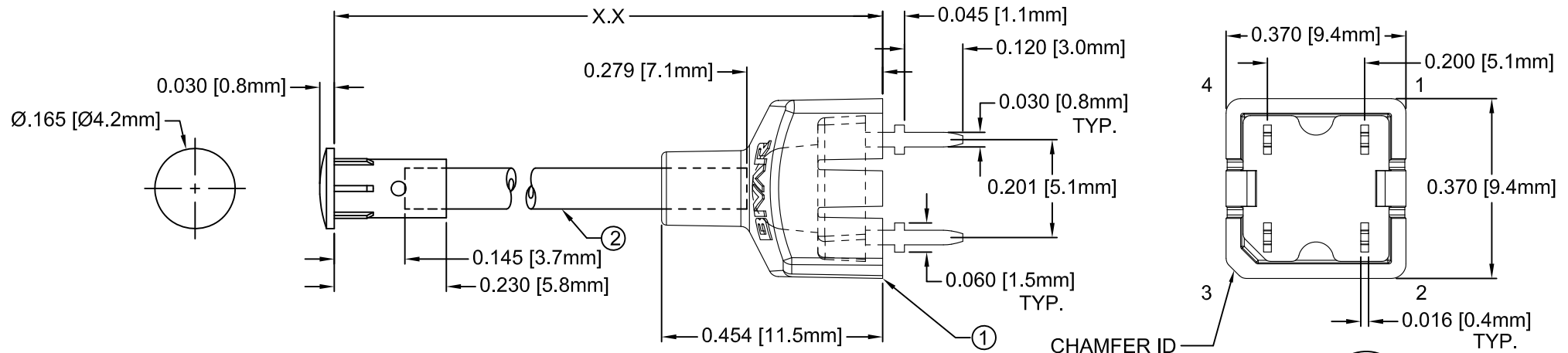

" X.X" *	Tolerance
1.0" ~ 16.0"	±0.050"
16.1" ~ 40.0"	±0.15"
40.1" ~ 80.0"	±0.30"
80.1" ~ 3,940.0"	±0.5%

* Available in 0.1" increments only

NOTE: ORFLP1-XXX ADAPTER SHIPPED SEPARATELY

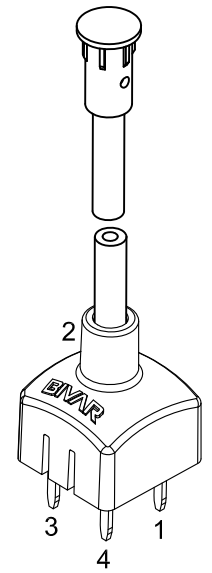

SEE PAGE 2 FOR POLARITY

ABSOLUTE MAXIMUM RATINGS (Ta=25°C)

REVERSE VOLTAGE _____	5V
REVERSE CURRENT _____	10uA
OPERATING TEMPERATURE RANGE _____	-25°C ~ +80°C
STORAGE TEMPERATURE _____	-30°C ~ +80°C
LEAD SOLDERING TEMPERATURE(1/16" FROM BODY) _____	260°C FOR 5 SECONDS

STANDARD TOLERANCE (UNLESS OTHERWISE SPECIFIED)		 BIVAR ® 4 THOMAS, IRVINE, CA. 92618 TEL: (949) 951-8808 FAX: (949) 951-3974	
DECIMALS	ANGULAR		
.X ±.2	X° ± 1°		
.XX ±.02		 TITLE: 1mm FLP ORCA ASSEMBLY, 3mm ROUND LENS CAP	
.XXX ±.010			
DESIGNED: Raffy Paje	DATE: 07/07/09	PART NO: R13-X.X-XXX	REVISION: B
CHECKED: F. Jensen	DATE: 07/07/09	CAGE CODE: 32559	SHEET # 1 OF 2
CAD GENERATED DOCUMENT, DO NOT MEASURE DRAWING.			

REV.	DESCRIPTION	DATE	APPROVED
	SEE SHEET #1		

Assy P/N	LED P/N	Emitted Color	Dominant Length λ_d (nm) / CCT (K)	Lens Appearance	Absolute Max. Ratings			Vf (V)			Iv (mcd)		Viewing Angle 2 $\theta_{1/2}$ (Deg)	POLARITY DIAGRAM
					Pd (mW)	If (mA)	Peak If (mA)	MIN	TYP	MAX	MIN	TYP		
SINGLE COLOR LED ASSEMBLIES (20mA)														
R13-X.X-BLU	R20BLU-4-0045	BLUE	465 - 475	WATER CLEAR	220	50	100	3.0	3.4	3.8	1000	1500	45	FIG. A
R13-X.X-GRN	R20GRN-4-0045	GREEN	516 - 526		220	50	100	3.0	3.4	3.8	6000	8000	45	FIG. A
R13-X.X-WHT	R20WHT-4-0045	WHITE	6000K		220	50	100	3.0	3.4	3.8	6000	8000	45	FIG. A
SINGLE COLOR LED ASSEMBLIES (50mA)														
R13-X.X-RED	R50RED-4-0045	RED	620 - 635	WATER CLEAR	140	80	160	2.0	2.4	2.8	5000	6000	45	FIG. A
R13-X.X-YLW	R50YLW-4-0045	YELLOW	588 - 594		140	80	160	2.0	2.4	2.8	5000	6000	45	FIG. A
BI-COLOR LED ASSEMBLIES (50mA)														
R13-X.X-RG	R50RG2-4-0045	RED	620 - 635	WATER CLEAR	150	80	160	2.2	2.6	3.0	3000	4000	45	FIG. B
		GREEN	515 - 525		220	80	150	3.4	3.8	4.4	4000	5000		
R13-X.X-RB	R50RB2-4-0045	RED	620 - 635	WATER CLEAR	150	80	160	2.2	2.6	3.0	3000	4000	45	FIG. C
		BLUE	460 - 470		220	80	150	3.4	3.8	4.4	200	400		
R13-X.X-BG	R50BG2-4-0045	BLUE	460 - 470	WATER CLEAR	220	80	150	3.4	3.8	4.4	200	400	45	FIG. D
		GREEN	515 - 525		220	80	150	3.4	3.8	4.4	4000	5000		
R13-X.X-RGB	R50RGB-4-0045	RED	620 - 635	WATER CLEAR	150	80	160	2.2	2.6	3.0	3000	4000	45	FIG. E
		GREEN	515 - 525		220	80	150	3.4	3.8	4.4	4000	5000		
		BLUE	460 - 470		220	80	150	3.4	3.8	4.4	200	400		

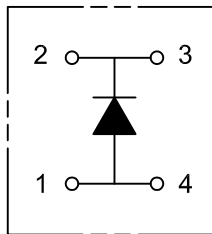

FIG. A

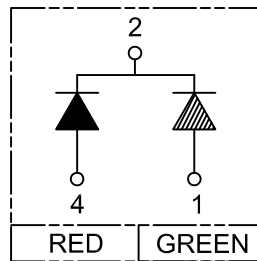

FIG. B

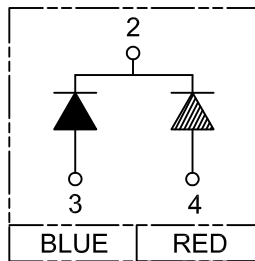

FIG. C

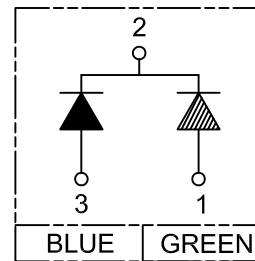

FIG. D

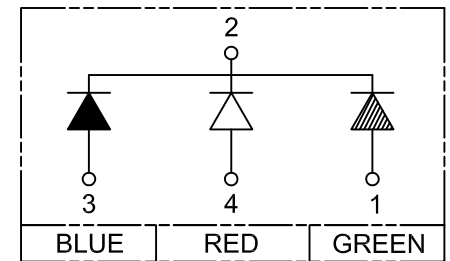

FIG. E

NOTES:

1. INDIVIDUAL LED P/N DATA AVAILABLE @ WWW.BIVAR.COM.

STANDARD TOLERANCE (UNLESS OTHERWISE SPECIFIED)		BIVAR [®] 4 THOMAS, IRVINE, CA. 92618 TEL: (949) 951-8808 FAX: (949) 951-3974	
DECIMALS	ANGULAR		
DESIGNED: Raffy Paje	DATE: 07/07/09	TITLE: 1mm FLP ORCA ASSEMBLY, 3mm ROUND LENS CAP	
CHECKED: F. Jensen	DATE: 07/07/09	PART NO: R13-X.X-XXX	REVISION: B
CAGE CODE : 32559		SHEET # 2 OF 2	
CAD GENERATED DOCUMENT, DO NOT MEASURE DRAWING.			