

## Photomicrosensor (Transmissive) EE-SX1096-W11

**⚠ Be sure to read *Precautions* on page 24.**

### ■ Dimensions

**Note:** All units are in millimeters unless otherwise indicated.

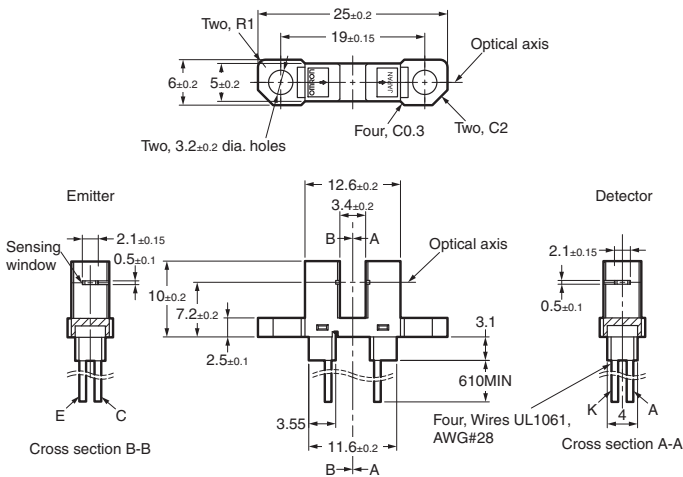

### Internal Circuit

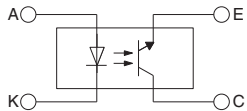

Unless otherwise specified, the tolerances are as shown below.

| Dimensions   | Tolerance |
|--------------|-----------|
| 3 mm max.    | ±0.3      |
| 3 < mm ≤ 6   | ±0.375    |
| 6 < mm ≤ 10  | ±0.45     |
| 10 < mm ≤ 18 | ±0.55     |
| 18 < mm ≤ 30 | ±0.65     |

| Terminal No. | Color | Name      |
|--------------|-------|-----------|
| A            | Red   | Anode     |
| K            | Black | Cathode   |
| C            | White | Collector |
| E            | Green | Emitter   |

### ■ Features

- Pre-wired Sensors (AWG28).
- Solder-less lead wire connection to increase reliability.
- With a horizontal aperture.

### ■ Absolute Maximum Ratings (Ta = 25°C)

| Item                | Symbol                    | Rated value               |
|---------------------|---------------------------|---------------------------|
| Emitter             | Forward current           | $I_F$ 50 mA (see note 1)  |
|                     | Pulse forward current     | $I_{FP}$ 1 A (see note 2) |
|                     | Reverse voltage           | $V_R$ 4 V                 |
| Detector            | Collector-Emitter voltage | $V_{CEO}$ 30 V            |
|                     | Emitter-Collector voltage | $V_{ECO}$ ---             |
|                     | Collector current         | $I_C$ 20 mA               |
|                     | Collector dissipation     | $P_C$ 100 mW (see note 1) |
| Ambient temperature | Operating                 | $T_{opr}$ -25°C to 80°C   |
|                     | Storage                   | $T_{stg}$ -25°C to 85°C   |

- Note:**
1. Refer to the temperature rating chart if the ambient temperature exceeds 25°C.
  2. The pulse width is 10 μs maximum with a frequency of 100 Hz.
  3. If you mount the Sensor with screws, use M3 screws, spring washers, and flat washers and use a tightening torque of 0.5 N·m max.
  4. You should use the product in the condition without any stress on the cable.

### ■ Electrical and Optical Characteristics (Ta = 25°C)

| Item         | Symbol                               | Value   | Condition                      |
|--------------|--------------------------------------|---|--------------------------------|
| Emitter      | Forward voltage                      | $V_F$ 1.2 V typ., 1.5 V max.                      | $I_F = 30$ mA                  |
|              | Reverse current                      | $I_R$ 0.01 μA typ., 10 μA max.                    | $V_R = 4$ V                    |
|              | Peak emission wavelength             | $\lambda_P$ 940 nm typ.                           | $I_F = 20$ mA                  |
| Detector     | Light current                        | $I_L$ 0.5 mA min., 14 mA max.                     | $I_F = 20$ mA, $V_{CE} = 10$ V |
|              | Dark current                         | $I_D$ 2 nA typ., 200 nA max.                      | $V_{CE} = 10$ V, 0 lx          |
|              | Leakage current                      | $I_{LEAK}$ ---                                    | ---                            |
|              | Collector-Emitter saturated voltage  | $V_{CE(sat)}$ 0.1 V typ., 0.4 V max.              | $I_F = 20$ mA, $I_L = 0.1$ mA  |
|              | Peak spectral sensitivity wavelength | $\lambda_P$ 850 nm typ.                           | $V_{CE} = 10$ V                |
| Rising time  | $t_r$ 4 μs typ.                      | $V_{CC} = 5$ V, $R_L = 100 \Omega$ , $I_L = 5$ mA |                                |
| Falling time | $t_f$ 4 μs typ.                      | $V_{CC} = 5$ V, $R_L = 100 \Omega$ , $I_L = 5$ mA |                                |

Engineering Data

Forward Current vs. Collector Dissipation Temperature Rating

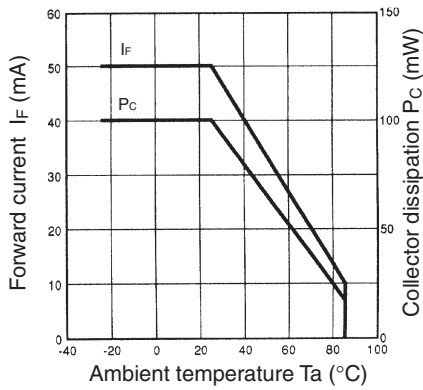

Forward Current vs. Forward Voltage Characteristics (Typical)

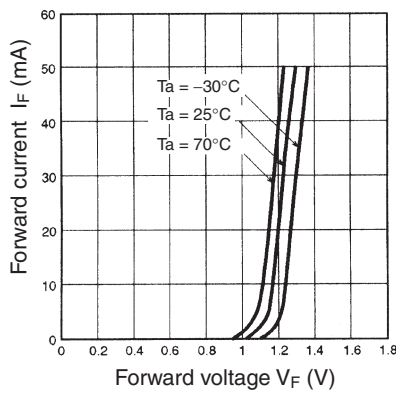

Light Current vs. Forward Current Characteristics (Typical)

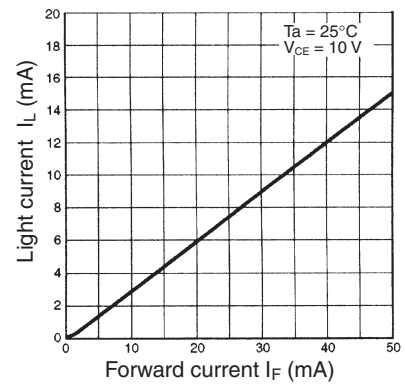

Light Current vs. Collector-Emitter Voltage Characteristics (Typical)

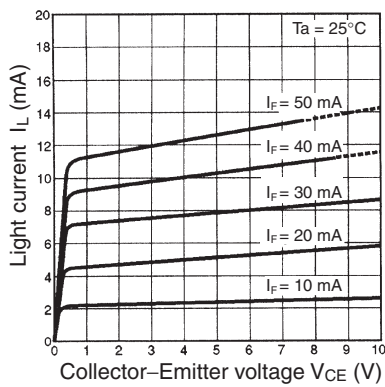

Relative Light Current vs. Ambient Temperature Characteristics (Typical)

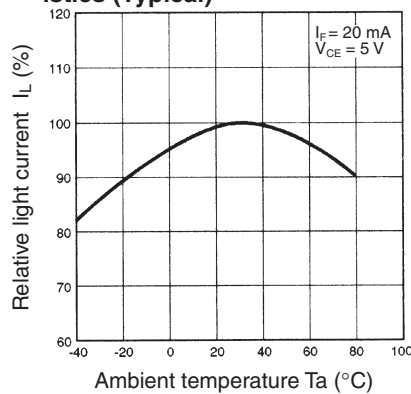

Dark Current vs. Ambient Temperature Characteristics (Typical)

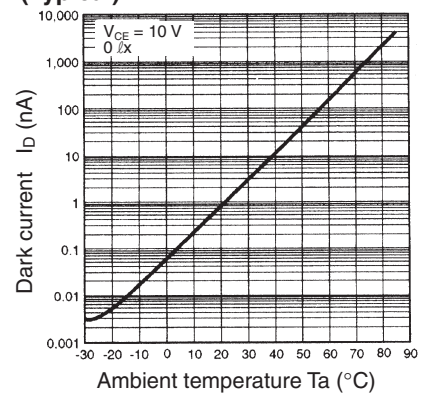

Response Time vs. Load Resistance Characteristics (Typical)

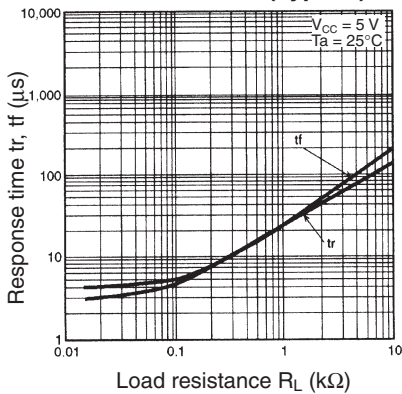

Sensing Position Characteristics (Typical)

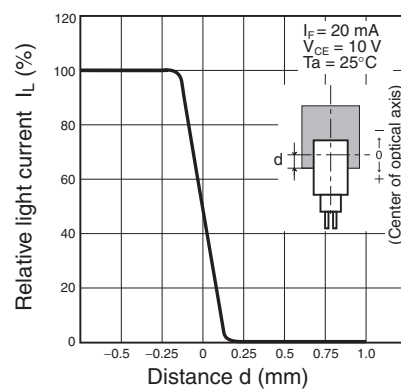

Sensing Position Characteristics (Typical)

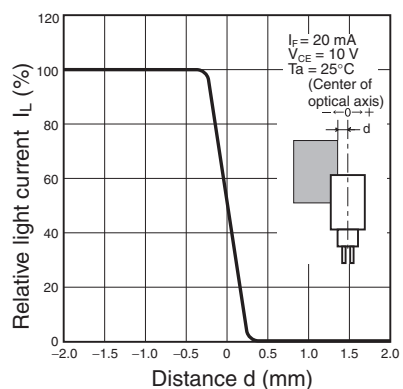

Response Time Measurement Circuit

