

The S-5843A Series is a temperature switch IC (thermostat IC) which detects the temperature with a temperature accuracy of $\pm 2.5^{\circ}\text{C}$.

The output inverts when temperature reaches the detection temperature. The S-5843A Series restores the output voltage when the temperature drops to the level of release temperature.

The S-5843A Series operates at the lower power supply voltage of 1.65 V and its current consumption is 4.5 μA typ. due to CMOS configuration.

A temperature sensor with the negative temperature coefficient, a reference voltage generation circuit, a comparator and a delay circuit are integrated on one chip, and enclosed into the packages SOT-23-5 and SNT-6A.

■ Features

- Detection temperature: $T_{\text{DET}} = +40^{\circ}\text{C}$ to $+120^{\circ}\text{C}$, $+1^{\circ}\text{C}$ step, detection accuracy: $\pm 2.5^{\circ}\text{C}$
- Low voltage operation: $V_{\text{DD}} = 1.65 \text{ V min.}$
- Low current consumption: $I_{\text{DD}} = 4.5 \mu\text{A typ. (Ta = +25}^{\circ}\text{C)}$
- Hysteresis temperature: selectable in 2°C , 4°C , 10°C or 20°C
- Selectable output logic in active "H" or "L"
- Selectable output form in CMOS or Nch open drain
- Prevent functions for false detection operation and false release operation
- Operation temperature range: $T_{\text{a}} = -40^{\circ}\text{C}$ to $+125^{\circ}\text{C}$
- Lead-free, Sn 100%, halogen-free^{*1}

*1. Refer to "■ Product Name Structure" for details.

■ Applications

- Fan control
- Air conditioning system
- Mobile phone
- Game console
- Various electronic devices

■ Packages

- SOT-23-5
- SNT-6A

■ Block Diagrams

1. CMOS output product



Figure 1

2. Nch open drain output product



Figure 2

■ Product Name Structure

Users are able to select the detection temperature, output form and logic, hysteresis temperature and package for the S-5843A Series.

1. Product name

1.1 SOT-23-5

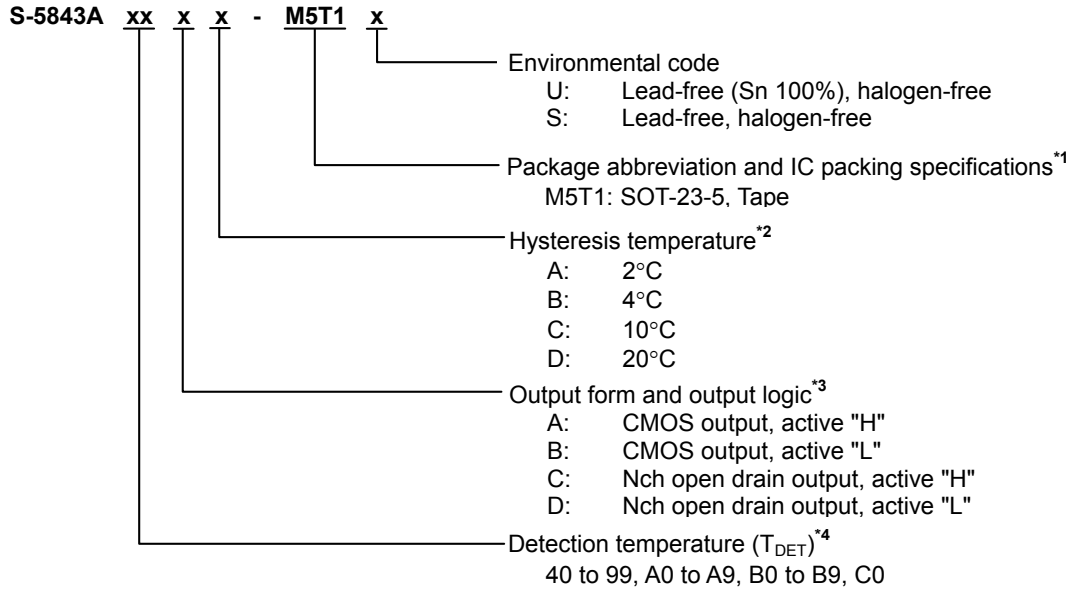

1.2 SNT-6A



*1. Refer to the tape drawing.
 *2. Hysteresis temperature is selectable in 2°C, 4°C, 10°C or 20°C.
 However, if the detection temperature is +40°C to +49°C, select hysteresis temperature in 2°C, 4°C or 10°C.
 *3. The DET pin output can be selected the output logic in active "H" or "L".
 The DET pin output can be selected the output form CMOS or Nch open drain.
 *4. Detection temperature (T_{DET}) can be set in the range of +40°C to +120°C at 1°C step.
 40 to 99, when detection temperature is +40°C to +99°C
 A0 to A9, when detection temperature is +100°C to +109°C
 B0 to B9, when detection temperature is +110°C to +119°C
 C0, when the detection temperature is +120°C

2. Packages

Table 1 Package Drawing Codes

Package Name	Dimension	Tape	Reel	Land
SOT-23-5	MP005-A-P-SD	MP005-A-C-SD	MP005-A-R-SD	–
SNT-6A	PG006-A-P-SD	PG006-A-C-SD	PG006-A-R-SD	PG006-A-L-SD

3. Product name list

3.1 SOT-23-5

Table 2

Product Name	Detection Temperature (T_{DET})	DET Pin Output Form	DET Pin Output Logic	Hysteresis Temperature (T_{HYS})
S-5843AC0DC-M5T1y	+120°C	Nch open drain	Active "L"	10°C

Remark 1. Please contact our sales office for products with specifications other than the above.

2. y: S or U
3. Please select products of environmental code = U for Sn 100%, halogen-free products.

3.2 SNT-6A

Table 3

Product Name	Detection Temperature (T_{DET})	DET Pin Output Form	DET Pin Output Logic	Hysteresis Temperature (T_{HYS})
S-5843A80CC-I6T1U	+80°C	Nch open drain	Active "H"	10°C
S-5843A90CC-I6T1U	+90°C	Nch open drain	Active "H"	10°C

Remark Please contact our sales office for products with specifications other than the above.

■ Pin Configurations

1. SOT-23-5

Top view

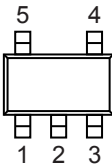

Figure 3

Table 4

Pin No.	Symbol	Description
1	NC ^{*1}	No connection
2	VSS	GND pin
3	RT ^{*2}	Test pin
4	VDD	Power supply pin
5	DET	Output pin

- *1. The NC pin is electrically open.
 The NC pin can be connected to VDD pin or VSS pin.
- *2. Set the RT pin open in use.

2. SNT-6A

Top view

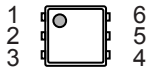

Figure 4

Table 5

Pin No.	Symbol	Description
1	RT ^{*1}	Test pin
2	VSS	GND pin
3	NC ^{*2}	No connection
4	DET	Output pin
5	NC ^{*2}	No connection
6	VDD	Power supply pin

- *1. Set the RT pin open in use.
- *2. The NC pin is electrically open.
 The NC pin can be connected to VDD pin or VSS pin.

■ Absolute Maximum Ratings

Table 6

(Ta = +25°C unless otherwise specified)

Item	Symbol	Absolute Maximum Rating	Unit
Power supply voltage ($V_{SS} = 0\text{ V}$)	V_{DD}	$V_{SS} + 7.0$	V
Pin voltage	V_{RT}	$V_{SS} - 0.3$ to $V_{DD} + 0.3$	V
Output voltage	CMOS output product	$V_{SS} - 0.3$ to $V_{DD} + 0.3$	V
	Nch open drain output product	$V_{SS} - 0.3$ to $V_{SS} + 7.0$	V
Output pin current	I_{DETH}	23.0	mA
	I_{DETL}	9.5	mA
Power dissipation	SOT-23-5	600^{*1}	mW
	SNT-6A	400^{*1}	mW
Operating ambient temperature	T_{opr}	-40 to +125	°C
Storage temperature	T_{stg}	-55 to +150	°C

*1. When mounted on board

[Mounted board]

- (1) Board size: 114.3 mm × 76.2 mm × t1.6 mm
- (2) Board name: JEDEC STANDARD51-7

Caution The absolute maximum ratings are rated values exceeding which the product could suffer physical damage. These values must therefore not be exceeded under any conditions.

■ **DC Electrical Characteristics**

1. **CMOS output product**

Table 7

(Ta = +25°C, unless otherwise specified)

Item	Symbol	Condition	Min.	Typ.	Max.	Unit	Test circuit
Power supply voltage	V _{DD}	–	1.65	–	5.5	V	1
Detection temperature *1	+T _D	–	T _{DET} – 2.5	T _{DET}	T _{DET} + 2.5	°C	1
Hysteresis temperature *2	T _{HYS}	–	–	2, 4, 10, 20	–	°C	1
Output current	I _{DETH}	Output transistor Pch V _{DET} = 2.2 V, V _{DD} = 3.0 V	2	9.4	–	mA	2
	I _{DETL}	Output transistor Nch V _{DET} = 0.4 V, V _{DD} = 3.0 V	0.5	2.3	–	mA	2
Current consumption during operation	I _{DD}	V _{DD} = 3.0 V	–	4.5	7.0	μA	1

*1. T_{DET}: Set value of detection temperature

*2. The hysteresis temperature is selectable in 2°C, 4°C, 10°C, or 20°C.

However, if the detection temperature is +40°C to +49°C, select hysteresis temperature in 2°C, 4°C or 10°C.

2. **Nch open drain output product**

Table 8

(Ta = +25°C, unless otherwise specified)

Item	Symbol	Condition	Min.	Typ.	Max.	Unit	Test circuit
Power supply voltage	V _{DD}	–	1.65	–	5.5	V	1
Detection temperature *1	+T _D	–	T _{DET} – 2.5	T _{DET}	T _{DET} + 2.5	°C	1
Hysteresis temperature *2	T _{HYS}	–	–	2, 4, 10, 20	–	°C	1
Output current	I _{DETL}	Output transistor Nch V _{DET} = 0.4 V, V _{DD} = 3.0 V	0.5	2.3	–	mA	2
Leakage current	I _{LEAK}	Output transistor Nch V _{DET} = 5.5 V, V _{DD} = 3.0 V	–	–	100	nA	2
Current consumption during operation	I _{DD}	V _{DD} = 3.0 V	–	4.5	7.0	μA	1

*1. T_{DET}: Set value of detection temperature

*2. The hysteresis temperature is selectable in 2°C, 4°C, 10°C, or 20°C.

However, if the detection temperature is +40°C to +49°C, select hysteresis temperature in 2°C, 4°C or 10°C.

[Fahrenheit ↔ Celsius Conversion equation]

$$^{\circ}\text{C} = (^{\circ}\text{F} - 32) \times 5 / 9$$

$$^{\circ}\text{F} = 32 + ^{\circ}\text{C} \times 9 / 5$$

■ **AC Electrical Characteristics**

Table 9

Item	Symbol	Condition	Min.	Typ.	Max.	Unit	Test circuit
Noise suppression time	t _{delay}	V _{DD} = 3.0 V, Ta = detection temperature	–	700	–	μs	–

■ Test circuits



*1. Resistor (R) is unnecessary for the CMOS output product.

Figure 5 Test Circuit 1



Figure 6 Test Circuit 2

■ Operation

1. Basic operation

The S-5843A Series is a temperature switch IC (thermostat IC) which detects temperature and sends a signal to an external device. The users can select various combinations of the parameters such as the detection temperature, the output form and logic, and hysteresis temperature.

Following is about the operation when the DET pin output logic is active "H".

After applying the power supply, the S-5843A Series starts to detect the temperature. If the temperature is lower than the detection temperature ($+T_D$), the DET pin output keeps "L". The temperature rises and exceeds the detection temperature, the DET pin output is set to "H".

After the detection, the temperature drops and reaches the release temperature ($+T_D - T_{HYS}$), the DET pin output returns to "L".

Figure 7 is the timing chart.



Figure 7 Operation when DET Pin Output Logic is Active "H"

2. Prevention functions for false detection operation and false release operation

The S-5843A Series sets the start-up control sequence and the noise suppression time (t_{delay}) via the delay circuit. By this, the S-5843A Series prevents false detection and false release operations which are caused by start-up and power supply fluctuation.

Following is about the operation when the DET pin output logic is active "H".

2.1 Operation at start-up

By the start-up control sequence, the S-5843A Series fixes the DET pin output "L" until the internal circuits become stable immediately after start-up. After that, the S-5843A Series starts the operation for temperature detection.

The DET pin output keeps "L" if ambient temperature (T_a) is the detection temperature ($+T_D$) or less. After that, if the temperature rises and exceeds the detection temperature, and this status is held for the noise suppression time or longer, the DET pin output is set to "H".

2.2 Operation at power supply fluctuation

The DET pin output is set to "L", if ambient temperature is the detection temperature or less. If any power supply fluctuation makes the internal circuit unstable, this status lasts shorter than the noise suppression time, the DET pin output is not set to "H". Thus, false detection operation by power supply fluctuation can be prevented. This is as well for the release operation.

■ Standard Circuit

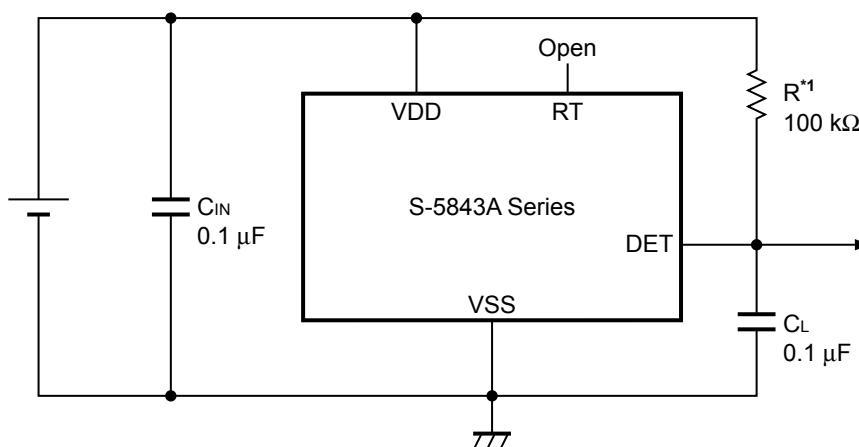

*1. Resistor (R) is unnecessary for the CMOS output product.

Figure 8

Caution The above connection diagram will not guarantee successful operation. Perform thorough evaluation using actual application to set the constant.

■ Precautions

- If power impedance is high, the S-5843A Series may malfunction due to voltage drop caused by feed-through current. Set wire patterns carefully for lower power impedance.
- The S-5843A Series sets the noise suppression time to prevent false detection and false release operations, however, the S-5843A Series may be affected by these operations under the condition with constant power supply noise. Use the S-5843A Series with a sufficiently stable power supply.
- It is recommended to set a capacitor (C_{IN}) of 0.1 μ F or more between the VDD pin and VSS pin for stabilization.
- It is recommended to set a capacitor (C_L) of about 0.1 μ F for the DET pin to prevent malfunction caused by the noise when the power supply is applied.
- The S-5843A Series may oscillate by setting a capacitor to the RT pin. Set the RT pin open in use.
- Do not apply an electrostatic discharge to this IC that exceeds the performance ratings of the built-in electrostatic protection circuit.
- ABLIC Inc. claims no responsibility for any disputes arising out of or in connection with any infringement by products, including this IC, of patents owned by a third party.

■ Characteristics (Typical Data)

1. Current consumption vs. Power supply voltage characteristics



2. DET pin current "H" vs. Power supply voltage characteristics (CMOS output product only)



3. DET pin current "L" vs. Power supply voltage characteristics

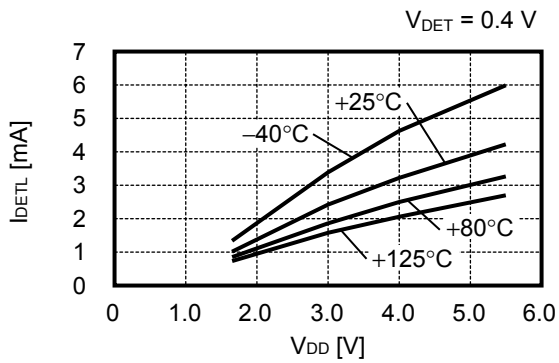

4. Noise suppression time vs. Power supply voltage characteristics



5. Response against heat (Output voltage vs. Time)

5.1 When packages are put into the air of +100 degrees from the air of +25 degrees at t = 0 s

$V_{DD} = 3.0\text{ V}$, $C_L = 0\ \mu\text{F}$, Detection temperature = $+80^\circ\text{C}$, Active "H"



5.2 When packages are put into the liquid of +100 degrees from the air of +25 degrees at t = 0 s

$V_{DD} = 3.0\text{ V}$, $C_L = 0\ \mu\text{F}$, Detection temperature = $+80^\circ\text{C}$, Active "H"



6. Response against startup

6.1 The detection temperature or lower ($T_a \leq +T_D$)

$C_L = 0\ \mu\text{F}$, Active "H"



6.2 Higher than the detection temperature ($T_a > +T_D$)

$C_L = 0\ \mu\text{F}$, Active "H"



■ **Marking Specifications**

1. SOT-23-5



(1) to (3): Product code (refer to **Product name vs. Product code**)
(4): Lot number

Product name vs. Product code

Product Name	Product Code		
	(1)	(2)	(3)
S-5843AC0DC-M5T1y	V	X	R

Remark 1. y: S or U

2. Please select products of environmental code = U for Sn 100%, halogen-free products.

2. SNT-6A



(1) to (3): Product code (refer to **Product name vs. Product code**)
(4) to (6): Lot number

Product name vs. Product code

Product Name	Product Code		
	(1)	(2)	(3)
S-5843A80CC-I6T1U	V	X	A
S-5843A90CC-I6T1U	V	X	B



No. MP005-A-P-SD-1.3

TITLE	SOT235-A-PKG Dimensions
No.	MP005-A-P-SD-1.3
ANGLE	
UNIT	mm
ABLIC Inc.	



Feed direction →

No. MP005-A-C-SD-2.1

TITLE	SOT235-A-Carrier Tape
No.	MP005-A-C-SD-2.1
ANGLE	
UNIT	mm
ABLIC Inc.	



Enlarged drawing in the central part



No. MP005-A-R-SD-1.1

TITLE	SOT235-A-Reel		
No.	MP005-A-R-SD-1.1		
ANGLE		QTY.	3,000
UNIT	mm		
ABLIC Inc.			

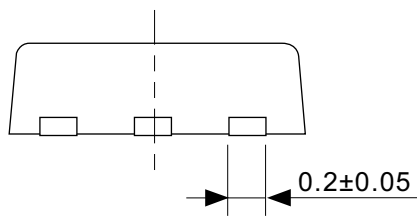
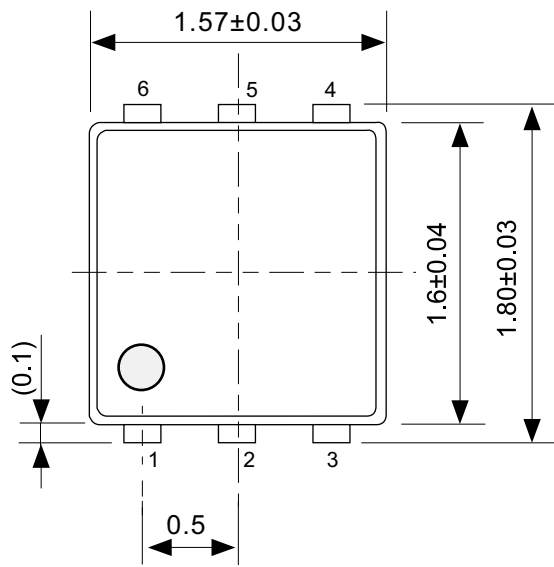

No. PG006-A-P-SD-2.1

TITLE	SNT-6A-A-PKG Dimensions
No.	PG006-A-P-SD-2.1
ANGLE	
UNIT	mm
ABLIC Inc.	



Feed direction →

No. PG006-A-C-SD-2.0

TITLE	SNT-6A-A-Carrier Tape
No.	PG006-A-C-SD-2.0
ANGLE	
UNIT	mm
ABLIC Inc.	



Enlarged drawing in the central part



No. PG006-A-R-SD-1.0

TITLE	SNT-6A-A-Reel		
No.	PG006-A-R-SD-1.0		
ANGLE		QTY.	5,000
UNIT	mm		
ABLIC Inc.			



※1. ランドパターンの幅に注意してください (0.25 mm min. / 0.30 mm typ.).
 ※2. パッケージ中央にランドパターンを広げないでください (1.30 mm ~ 1.40 mm)。

- 注意
1. パッケージのモールド樹脂下にシルク印刷やハンダ印刷などしないでください。
 2. パッケージ下の配線上のソルダーレジストなどの厚みをランドパターン表面から0.03 mm以下にしてください。
 3. マスク開口サイズと開口位置はランドパターンと合わせてください。
 4. 詳細は "SNTパッケージ活用の手引き" を参照してください。

※1. Pay attention to the land pattern width (0.25 mm min. / 0.30 mm typ.).
 ※2. Do not widen the land pattern to the center of the package (1.30 mm ~ 1.40 mm).

- Caution**
1. Do not do silkscreen printing and solder printing under the mold resin of the package.
 2. The thickness of the solder resist on the wire pattern under the package should be 0.03 mm or less from the land pattern surface.
 3. Match the mask aperture size and aperture position with the land pattern.
 4. Refer to "SNT Package User's Guide" for details.

※1. 请注意焊盘模式的宽度 (0.25 mm min. / 0.30 mm typ.).
 ※2. 请勿向封装中间扩展焊盘模式 (1.30 mm ~ 1.40 mm)。

- 注意
1. 请勿在树脂型封装的下面印刷丝网、焊锡。
 2. 在封装下、布线上的阻焊膜厚度 (从焊盘模式表面起) 请控制在 0.03 mm 以下。
 3. 钢网的开口尺寸和开口位置请与焊盘模式对齐。
 4. 详细内容请参阅 "SNT 封装的应用指南"。

No. PG006-A-L-SD-4.1

TITLE	SNT-6A-A -Land Recommendation
No.	PG006-A-L-SD-4.1
ANGLE	
UNIT	mm
ABLIC Inc.	

Disclaimers (Handling Precautions)

1. All the information described herein (product data, specifications, figures, tables, programs, algorithms and application circuit examples, etc.) is current as of publishing date of this document and is subject to change without notice.
2. The circuit examples and the usages described herein are for reference only, and do not guarantee the success of any specific mass-production design.
ABLIC Inc. is not responsible for damages caused by the reasons other than the products described herein (hereinafter "the products") or infringement of third-party intellectual property right and any other right due to the use of the information described herein.
3. ABLIC Inc. is not responsible for damages caused by the incorrect information described herein.
4. Be careful to use the products within their specified ranges. Pay special attention to the absolute maximum ratings, operation voltage range and electrical characteristics, etc.
ABLIC Inc. is not responsible for damages caused by failures and / or accidents, etc. that occur due to the use of the products outside their specified ranges.
5. When using the products, confirm their applications, and the laws and regulations of the region or country where they are used and verify suitability, safety and other factors for the intended use.
6. When exporting the products, comply with the Foreign Exchange and Foreign Trade Act and all other export-related laws, and follow the required procedures.
7. The products must not be used or provided (exported) for the purposes of the development of weapons of mass destruction or military use. ABLIC Inc. is not responsible for any provision (export) to those whose purpose is to develop, manufacture, use or store nuclear, biological or chemical weapons, missiles, or other military use.
8. The products are not designed to be used as part of any device or equipment that may affect the human body, human life, or assets (such as medical equipment, disaster prevention systems, security systems, combustion control systems, infrastructure control systems, vehicle equipment, traffic systems, in-vehicle equipment, aviation equipment, aerospace equipment, and nuclear-related equipment), excluding when specified for in-vehicle use or other uses. Do not apply the products to the above listed devices and equipments without prior written permission by ABLIC Inc. Especially, the products cannot be used for life support devices, devices implanted in the human body and devices that directly affect human life, etc.
Prior consultation with our sales office is required when considering the above uses.
ABLIC Inc. is not responsible for damages caused by unauthorized or unspecified use of our products.
9. Semiconductor products may fail or malfunction with some probability.
The user of the products should therefore take responsibility to give thorough consideration to safety design including redundancy, fire spread prevention measures, and malfunction prevention to prevent accidents causing injury or death, fires and social damage, etc. that may ensue from the products' failure or malfunction.
The entire system must be sufficiently evaluated and applied on customer's own responsibility.
10. The products are not designed to be radiation-proof. The necessary radiation measures should be taken in the product design by the customer depending on the intended use.
11. The products do not affect human health under normal use. However, they contain chemical substances and heavy metals and should therefore not be put in the mouth. The fracture surfaces of wafers and chips may be sharp. Be careful when handling these with the bare hands to prevent injuries, etc.
12. When disposing of the products, comply with the laws and ordinances of the country or region where they are used.
13. The information described herein contains copyright information and know-how of ABLIC Inc.
The information described herein does not convey any license under any intellectual property rights or any other rights belonging to ABLIC Inc. or a third party. Reproduction or copying of the information from this document or any part of this document described herein for the purpose of disclosing it to a third-party without the express permission of ABLIC Inc. is strictly prohibited.
14. For more details on the information described herein, contact our sales office.

2.2-2018.06

Mouser Electronics

Authorized Distributor

Click to View Pricing, Inventory, Delivery & Lifecycle Information:

ABLIC:

[S-5843A80CC-I6T1U](#) [S-5843A90CC-I6T1U](#) [S-5843AA5DC-I6T1U](#) [S-5843A85AD-M5T1U](#) [S-5843AAODC-I6T1U](#) [S-5843A80DC-M5T1U](#) [S-5843AA7DD-I6T1U](#) [S-5843A48AB-M5T1U](#) [S-5843A72DD-I6T1U](#) [S-5843A52AA-M5T1U](#) [S-5843AAODD-I6T1U](#) [S-5843A70DD-I6T1U](#) [S-5843A90DD-I6T1U](#) [S-5843A68AD-M5T1U](#) [S-5843A80DD-I6T1U](#) [S-5843A85DD-I6T1U](#) [S-5843AC0DC-M5T1U](#) [S-5843A60AC-I6T1U](#) [S-5843A75DC-M5T1U](#) [S-5843A40AA-M5T1U](#) [S-5843ABODD-I6T1U](#) [S-5843A90DC-I6T1U](#) [S-5843A75DD-I6T1U](#) [S-5843A95DC-I6T1U](#) [S-5843A80AD-M5T1U](#) [S-5843AA5DC-M5T1U](#) [S-5843A44AA-M5T1U](#) [S-5843A70DA-M5T1U](#) [S-5843A95DC-M5T1U](#) [S-5843A54AA-M5T1U](#) [S-5843ABODC-I6T1U](#) [S-5843A70DB-M5T1U](#) [S-5843ABODC-M5T1U](#) [S-5843A90DC-M5T1U](#) [S-5843A65DA-M5T1U](#) [S-5843A78CD-M5T1U](#) [S-5843A85DC-M5T1U](#) [S-5842A73AD-M5T1U](#)