



Main

Range of product	Phaseo
Product or component type	Battery control module
Input voltage	24...28.8 V DC
Output voltage	(U _{battery} -0.5) V in battery mode DC (U _{in} -0.25) V in nominal mode DC
Maximum output current	40 A

Complementary

Input voltage limits	22...30 V
Current consumption	<= 40.6 A 0.6 A, on load 0.1 mA, no load
Power dissipation in W	<= 12 W
Activation threshold	Adjustable 22...36 V
Number of output channels	1
Output protection type	Against overload, protection technology: 1.5 x I _n Against short-circuits, protection technology: battery-backed mode, automatic reset Against short-circuits, protection technology: power-supplied mode
Connections - terminals	Removable screw terminal block diagnostic relay, connection capacity: 1 x 0.75 mm ² Screw type terminals input connection, connection capacity: 2 x 0.5...2 x 10 mm ² AWG 20...AWG 8 Screw type terminals output connection, connection capacity: 2 x 0.5...2 x 10 mm ² AWG 20...AWG 8
Fixing mode	By clips on 35 mm symmetrical DIN rail, operating position: horizontal By clips on 35 mm symmetrical DIN rail, operating position: vertical
Marking	CE
Name of test	Electrostatic discharges conforming to EN/IEC 61000-4-2 Emission conforming to EN 61000-6-3 Induced electromagnetic field conforming to EN/IEC 61000-4-6 level 3 Radiated electromagnetic field conforming to EN/IEC 61000-4-3 level 3 Rapid transient conforming to IEC 61000-4-4 level 3 Surge conforming to EN/IEC 61000-4-5 level 2 Conducted/radiated emissions conforming to EN 55022 Class B, 20 % derating factor
Local signalling	1 C/O relay, function: alarm status 1 C/O relay, function: battery status 1 C/O relay, function: power supply status LCD screen, function: module status
Product weight	1.54 lb(US) (0.7 kg)

Environment

IP degree of protection	Conforming to EN/IEC 60529
ambient air temperature for operation	-13...140 °F (-25...60 °C)
ambient air temperature for storage	-40...185 °F (-40...85 °C)
relative humidity	0...90 % during operation 0...95 % during storage
overvoltage category	Class II conforming to VDE 0106-1
vibration resistance	3.5 mm (f = 3...11.9 Hz) conforming to EN/IEC 61131-2 2 gn (f = 11.9...150 Hz) conforming to EN/IEC 61131-2
dielectric strength	500 V between input and ground

The information provided in this documentation contains general descriptions and/or technical characteristics of the products contained herein. This documentation is not intended as a substitute for and is not to be used for determining suitability or reliability of these products for specific user applications. It is the duty of any such user or integrator to perform the appropriate and complete risk analysis, evaluation and testing of the products with respect to the relevant specific application or use thereof. Neither Schneider Electric Industries SAS nor any of its affiliates or subsidiaries shall be responsible or liable for misuse of the information contained herein.

	500 V between output and ground
product certifications	RCM EAC
standards	UL 508 CSA C22.2 No 60950-1
environmental characteristic	EMC conforming to EN 61000-6-3 EMC conforming to EN/IEC 61000-6-2 Safety conforming to EN/IEC 60950-1 Safety conforming to EN/IEC 61204-3

Offer Sustainability

Green Premium product	Green Premium product
Compliant - since 0501 - Schneider Electric declaration of conformity	Compliant - since 0501 - Schneider Electric declaration of conformity
Reference contains SVHC above the threshold - go to CaP for more details	Reference contains SVHC above the threshold
Available	Available
Available	Available
WARNING: This product can expose you to chemicals including:	WARNING: This product can expose you to chemicals including:
Lead and lead compounds, which is known to the State of California to cause cancer and birth defects or other reproductive harm.	Lead and lead compounds, which is known to the State of California to cause cancer and birth defects or other reproductive harm.
For more information go to www.p65warnings.ca.gov	For more information go to www.p65warnings.ca.gov

Contractual warranty

Warranty period	18 months
-----------------	-----------

24 Vdc/40 A Battery Control Module

Dimensions

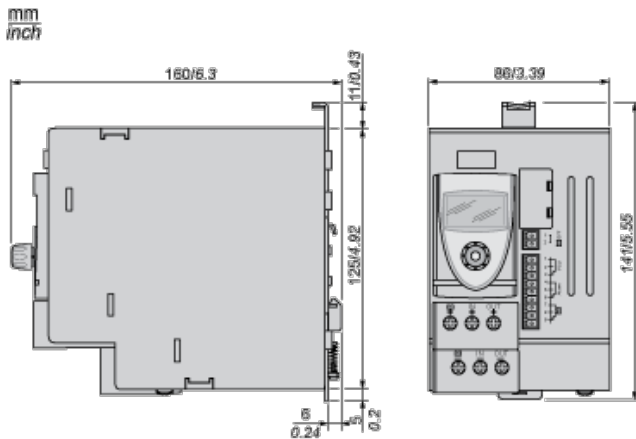

24 Vdc Battery Control Module

Mounting

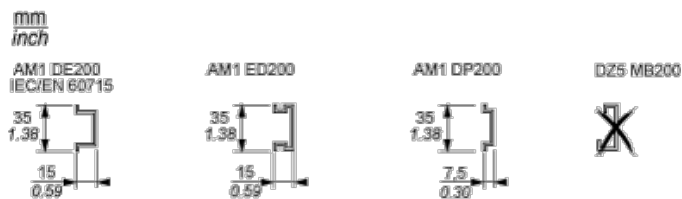

24 Vdc Battery Control Module

Clearance

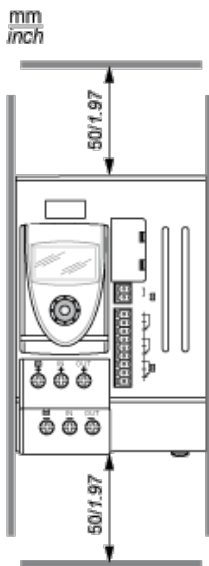

24 Vdc Battery Control Module

Wiring Diagram

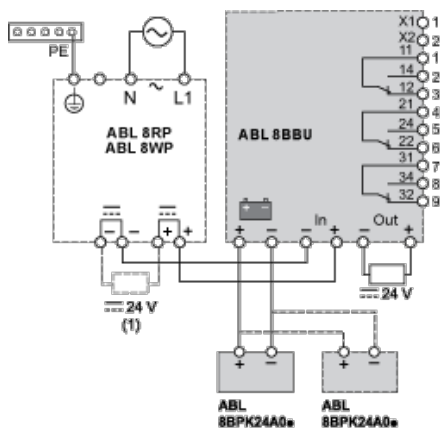

(1) See table below for the maximum unstored charge capacity (μF)

ABL	Max. Unstored Charge Capacity (μF)
8RPS24030	30 000
8RPS24050	50 000
8RPS24100	100 000
8RPM24200	100 000
8WPS24200	100 000
8WPS24400	100 000

24 Vdc Battery Control Module

Outputs States ($U = 24 \text{ Vdc}$: $I > 5 \text{ mA}$, $U = 230 \text{ Vac}$: $I < 500 \text{ mA}$)

	No power from the power supply		Power from the power supply
	Alarm or device not supplied		No alarm
	No power from the battery pack		Power from the battery pack



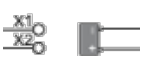
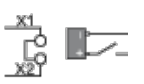





Inputs States (Dry Contact)

	Operational battery		Battery inhibited
--	---------------------	--	-------------------









Wiring Requirements

Cable Types and Wire Sizes

IEC / EN

		ABL 8RPS24030 8RPS24050 8RPS24100	ABL 8RPM24200 8WPS24200 8WPS24400
	$\varnothing \leq 4 \text{ mm}^2$		
	$\varnothing > 4 \text{ mm}^2$		
ABL 8BBU24200	In + / -	1...4 mm ²	4...10 mm ²
	 + / -	6 mm ²	-
	Out + / -	6 mm ²	-
ABL 8BBU24400	In + / -	1...4 mm ²	4...10 mm ²
	 + / -	10 mm ²	=
	Out + / -	10 mm ²	=
		10 mm ²	-
			
 OFF / PSU / Alarm / 		0,14...1 mm ²	

UL

		ABL 8RPS24030 8RPS24050 8RPS24100	ABL 8RPM24200 8WPS24200 8WPS24400
	$\varnothing \leq 12 \text{ AWG}$		
	$\varnothing > 12 \text{ AWG}$		
ABL 8BBU24200	In + / -	16...12 AWG	12...6 AWG
	 + / -	10 AWG	-
	Out + / -	10 AWG	-
ABL 8BBU24400	In + / -	16...12 AWG	12...6 AWG
	 + / -	6 AWG	=
	Out + / -	6 AWG	=
		6 AWG	-
			
 OFF / PSU / Alarm / 		28...16 AWG	