

RP327 Series

Bookshelf, 3-Phase Delta Dual Stage Power Line Filter

RP327 3 PHASE TO 250A BOOKSHELF DESIGN

ROHS COMPLIANT



SPECIFICATIONS

Operating Freq.	: 50/60Hz
Usable Freq.	: DC - 400Hz
Max. Operating Voltage	: 480V +10%
Ambient Temperature	: -25 to 50C
Climatic Category	: 25/100/21
Hipot Rating (L-G)	: 3500VDC
Terminals (-T)	: S: 7/16/30/42/55A (M5) 75/100A (M6) 130/180/250A (M10)
Safety Approvals	: UR, CSA, EN60939

LEAKAGE CURRENT

Y-cap, nF	mA, 480V/60Hz
0	0
10	0.1
100	1
1000	10
2000	20

PART NUMBER/ ORDERING

RP327	-X (Amps)	-Y (Ycap, nF)	-T	Weight LBS (KG) Typ.
	7	0	S	5.0 (2.3)
	16	10		7.0 (3.2)
	30	100		10.0 (4.5)
	42	1000		13.3 (5.9)
	55	2000		13.5 (6.1)
	75			14.0 (6.4)
	100			18.0 (8.2)
	130			27.0 (12.3)
	180			27.5 (12.5)
	250			31.0 (14.1)

Note: Use any combination of -Y with any -X (Amps) rating
e.g. RP327-180-100-S (180 Amps with 100nF Ycap)

SCHEMATIC

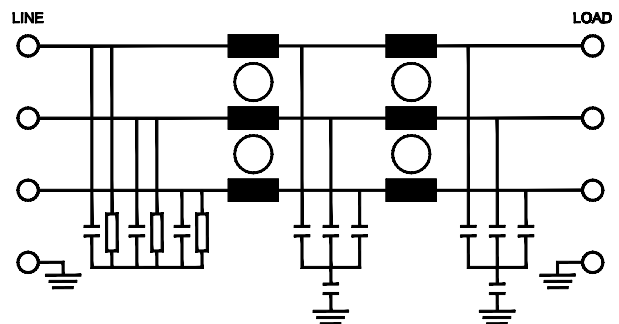

Reference purposes only.
Specifications are subject to change.
Consult factory to verify specifications.

RP327

Typical Insertion Loss, dB (50/50ohm)

Mechanical Drawings

7/16 Amp					
FREQ (MHz)	.15	.5	1	10	30
CM (dB)	65	70	70	55	40
DM (dB)	55	70	70	70	60

30 Amp					
FREQ (MHz)	.15	.5	1	10	30
CM (dB)	65	70	70	50	30
DM (dB)	60	70	70	70	50

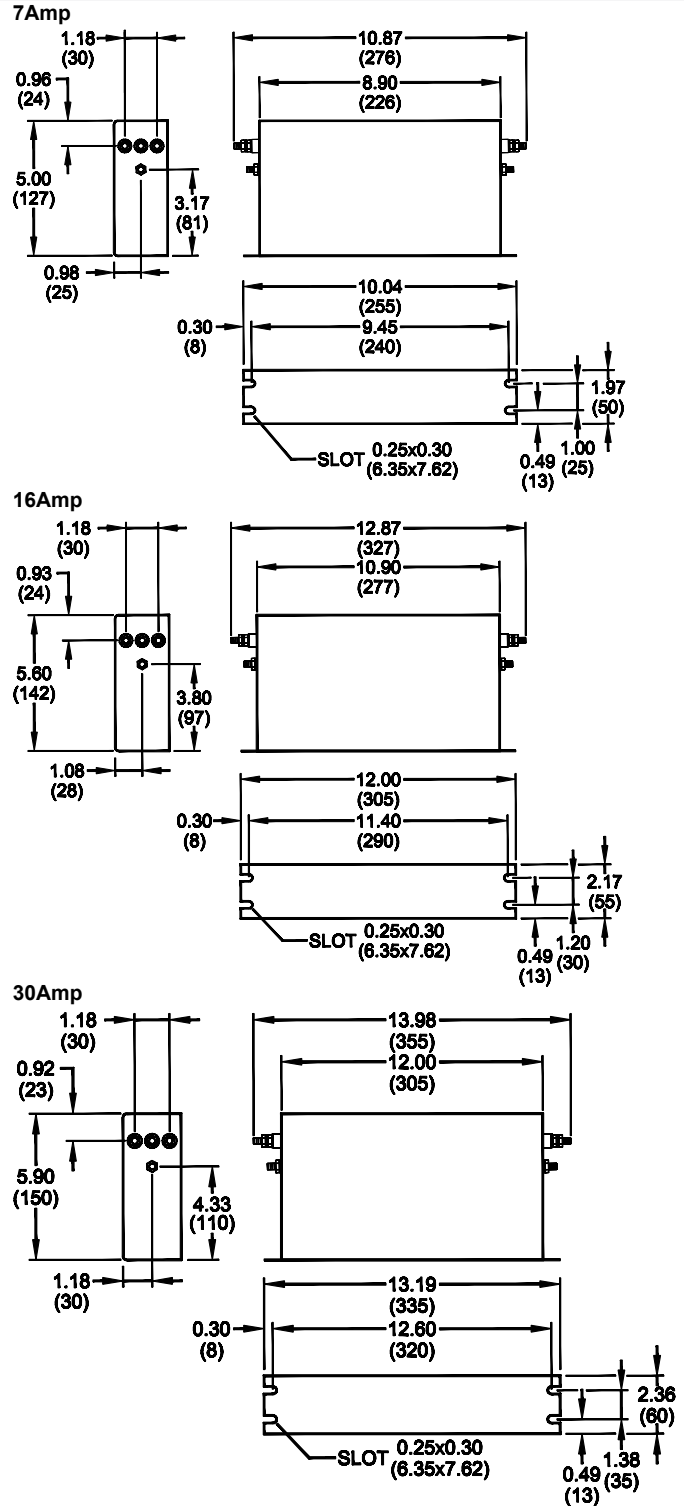

TYPICAL TOLERANCE: +/-0.02 (0.50)

www.radiuspower.com

Reference purposes only.
Specifications are subject to change.
Consult factory to verify specifications.

RP327

Typical Insertion Loss, dB (50/50ohm)

Mechanical Dimensions

42 Amp					
FREQ (MHz)	.15	.5	1	10	30
CM (dB)	70	70	70	70	50
DM (dB)	55	70	70	65	50

55 Amp					
FREQ (MHz)	.15	.5	1	10	30
CM (dB)	70	70	70	70	50
DM (dB)	55	70	70	65	50

75 Amp					
FREQ (MHz)	.15	.5	1	10	30
CM (dB)	65	70	70	60	30
DM (dB)	40	70	70	65	40

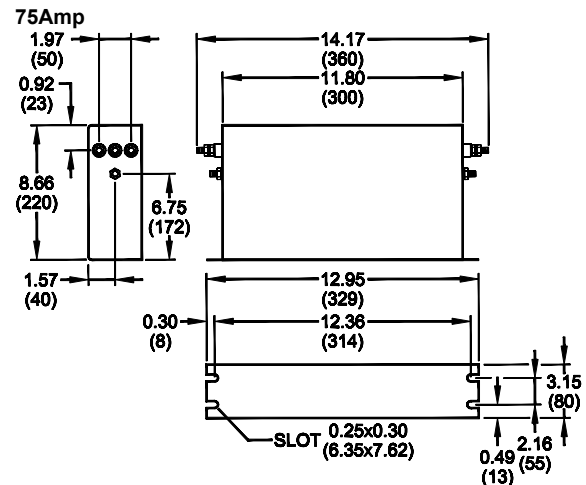
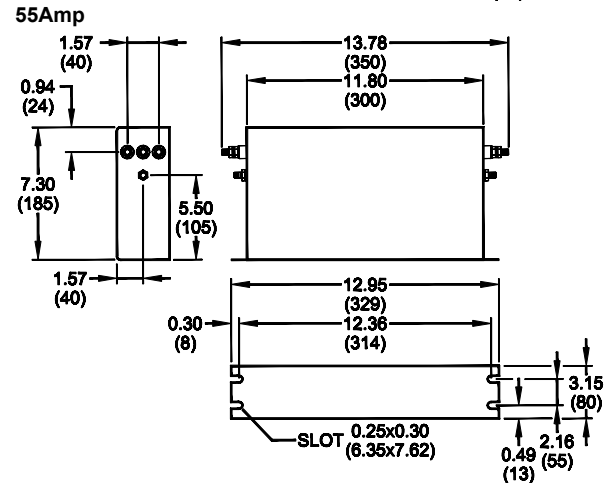

TYPICAL TOLERANCE: +/-0.02 (0.50)

www.radiuspower.com

Reference purposes only.
Specifications are subject to change.
Consult factory to verify specifications.

RP327

Typical Insertion Loss, dB (50/50ohm)

Mechanical Dimensions

100 Amp					
FREQ (MHz)	.15	.5	1	10	30
CM (dB)	65	70	70	60	30
DM (dB)	40	70	70	65	40

130 Amp					
FREQ (MHz)	.15	.5	1	10	30
CM (dB)	52	70	65	40	25
DM (dB)	45	70	70	60	50

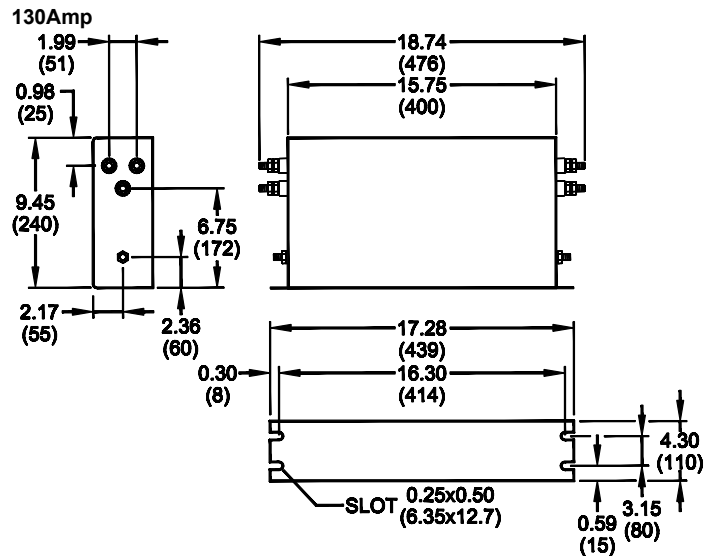
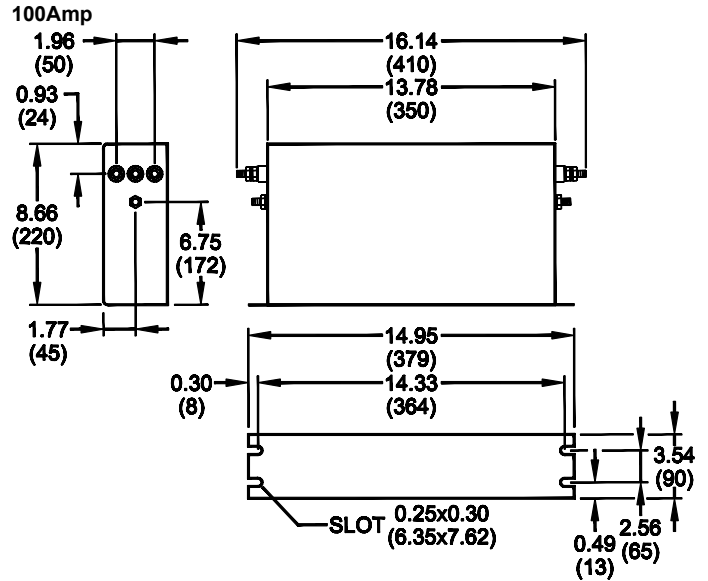

TYPICAL TOLERANCE: +/-0.02 (0.50)

Reference purposes only.
Specifications are subject to change.
Consult factory to verify specifications.

RP327

Typical Insertion Loss, dB (50/50ohm)

Mechanical Dimensions

180 Amp					
FREQ (MHz)	.15	.5	1	10	30
CM (dB)	55	70	70	40	20
DM (dB)	55	70	60	45	25

250 Amp					
FREQ (MHz)	.15	.5	1	10	30
CM (dB)	65	70	70	40	26
DM (dB)	65	65	60	45	38

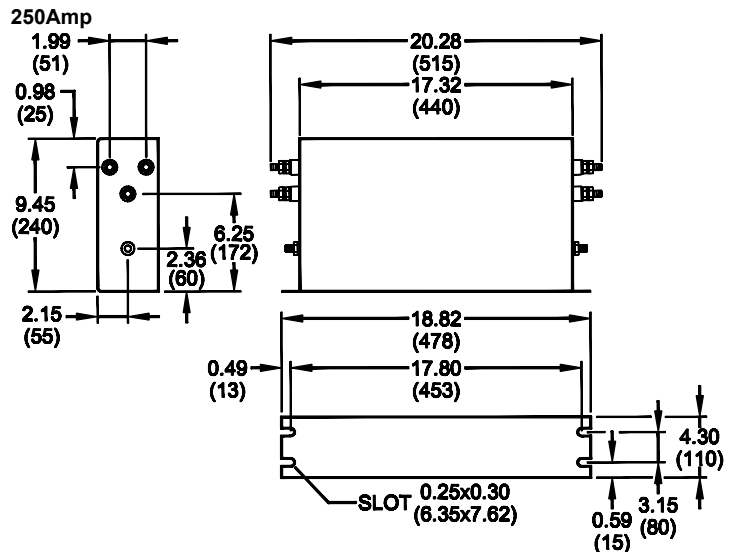
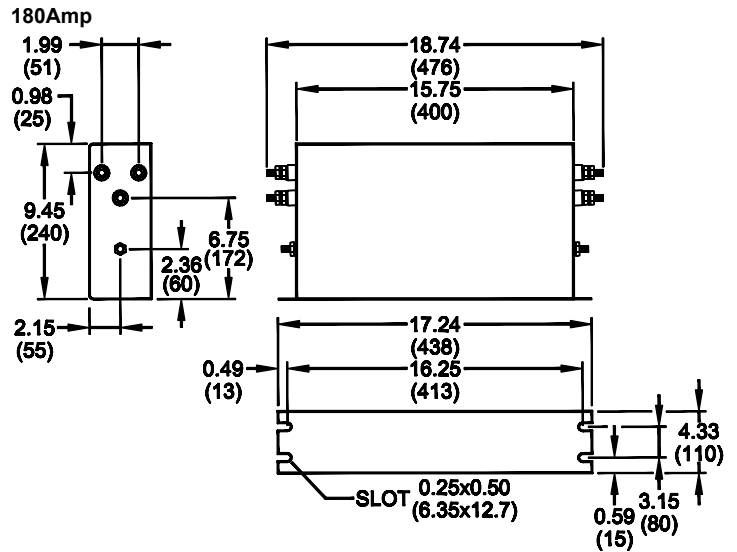

TYPICAL TOLERANCE: +/-0.02 (0.50)

Reference purposes only.
Specifications are subject to change.
Consult factory to verify specifications.