

# Preliminary

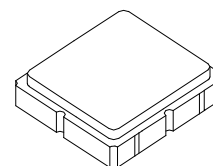

**SF2126E**

**725.00 MHz  
SAW Filter**



**SM3030-8**

- *RF Filter for Wimax Application*
- *3.0 x 3.0mm Surface Mount Case*
- *50W Input / Output Impedance*

### Absolute Maximum Ratings

Rating	Value	Units
Input Power Level	15	dBm
DC Voltage	3	V
Operating Temperature Range	-30 to +85	°C
Storage Temperature Range	-40 to +85	°C

### Electrical Characteristics

Characteristic	Sym	Notes	Min	Typ	Max	Units
Nominal Center Frequency	$F_C$			725		MHz
Frequency Range			700		750	MHz
Insertion Loss	IL			2.6	3.0	dB
Ripple		700 - 750 MHz		1	1.5	
VSWR					2.2	
Attenuation (absolute)		500 - 600 MHz	40			
		601 - 650 MHz	30			
		651 - 665 MHz	20			
		780 - 824 MHz	15			
		825 - 844 MHz	30			
		845 - 960 MHz	40			
Source Impedance	$Z_S$			50		$\Omega$
Load Impedance	$Z_L$			50		$\Omega$

Case Style	SM3030-8 3.0 x 3.0 mm Nominal Footprint
Lid Symbolization (Y=year, WW=week, S=shift) dot=pin 1 indicator	648, YWWS
Standard Reel Quantity	1000 Pieces/Reel
Reel Size 7 Inch	
Reel Size 13 Inch	3000 Pieces/Reel

### Notes:

1. Unless noted otherwise, all specifications apply over the operating temperature range with filter soldered to the specified demonstration board with impedance matching to 50  $\Omega$  and measured with 50  $\Omega$  network analyzer.
2. Unless noted otherwise, all frequency specifications are referenced to the nominal center frequency, fc.
3. The design, manufacturing process, and specifications of this filter are subject to change.
4. US and international patents may apply.
5. RFM, stylized RFM logo, and RF Monolithics, Inc. are registered trademarks of RF Monolithics, Inc.
6. ©Copyright 1999, RF Monolithics Inc.
7. Electrostatic Sensitive Device. Observe precautions for handling.



## Frequency Characteristics:

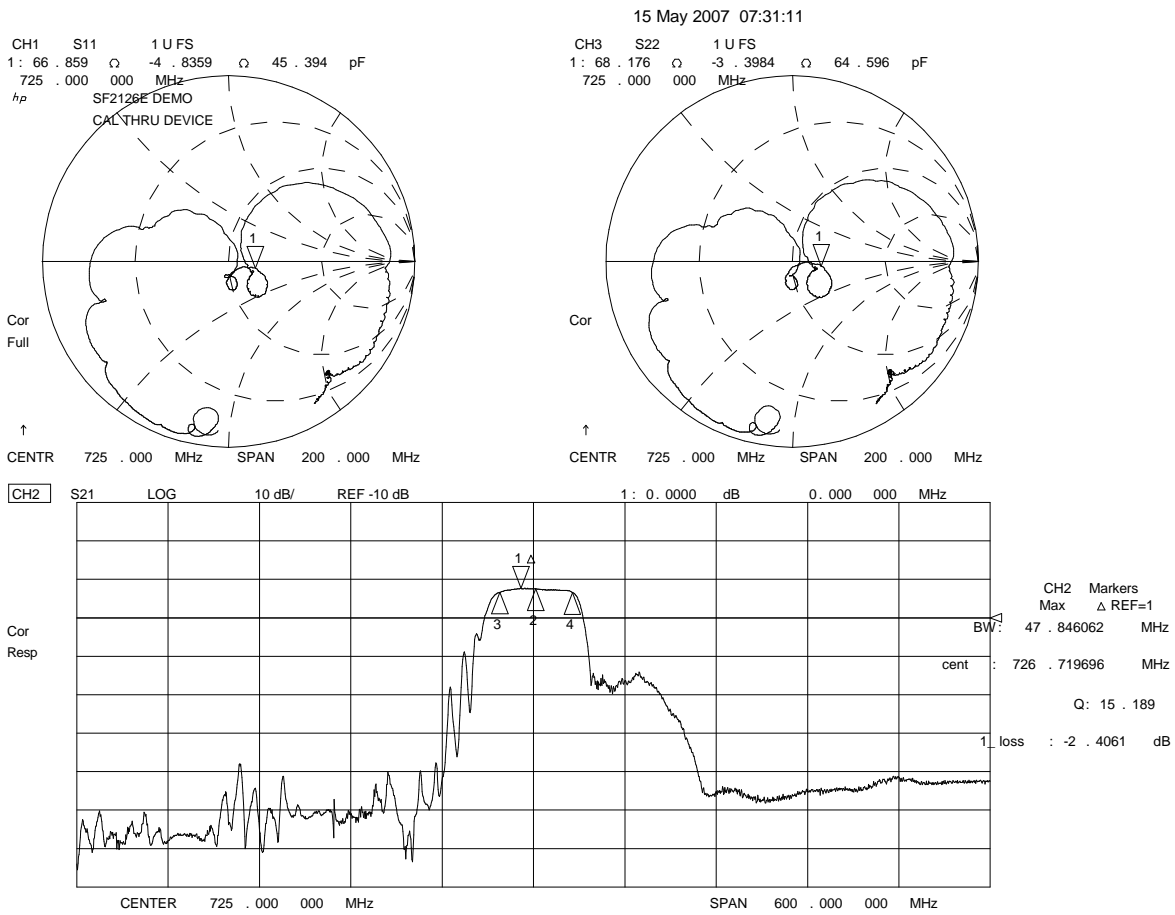

## Tape and Reel Specifications

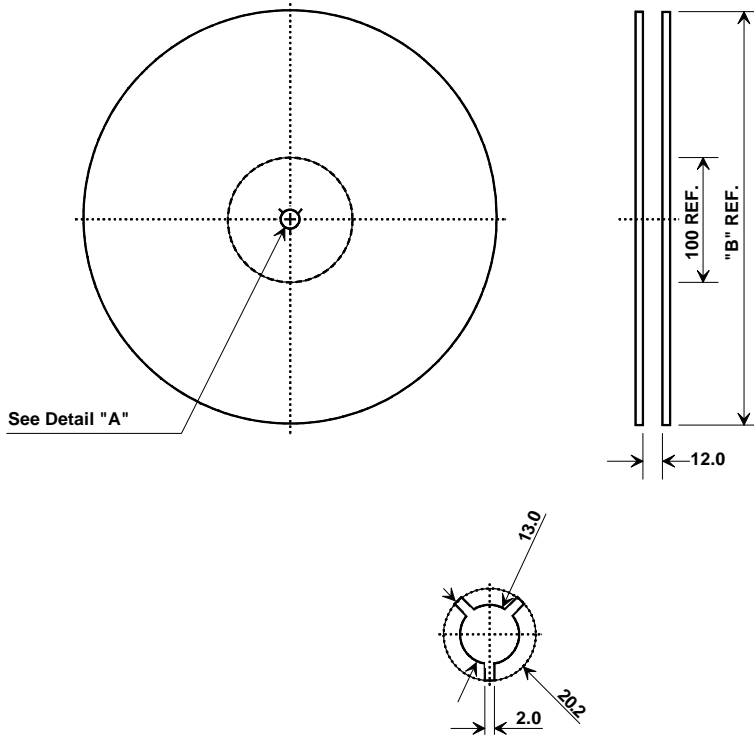

"B "	
Nominal Size	
Inches	millimeters
7	178
13	330

## COMPONENT ORIENTATION and DIMENSIONS

Carrier Tape Dimensions	
Ao	3.35 mm
Bo	3.35 mm
Ko	1.40 mm
Pitch	8.0 mm
W	12.0 mm

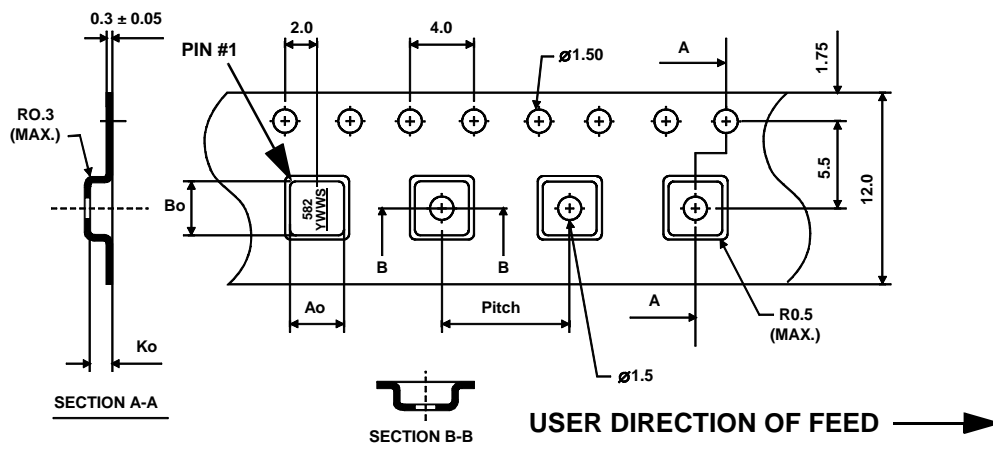

# SM3030-8 Case

## 8-Terminal Ceramic Surface-Mount Case 3.0 X 3.0 mm Nominal Footprint

### Case Dimensions

Dimension	mm			Inches		
	Min	Nom	Max	Min	Nom	Max
A	2.87	3.0	3.13	0.113	0.118	0.123
B	2.87	3.0	3.13	0.113	0.118	0.123
C	1.14	1.27	1.40	0.045	0.050	0.055
D	0.79	0.92	1.05	0.031	0.036	0.041
E	0.62	0.75	0.88	0.024	0.029	0.034
F	0.47	0.60	0.73	0.018	0.024	0.029
G	0.47	0.60	0.73	0.018	0.024	0.029
H	1.07	1.20	1.33	0.042	0.047	0.052

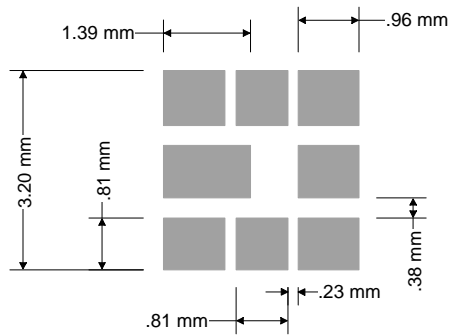
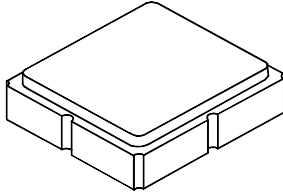

Foot Print Dimensions

### Electrical Connections

	Connection	Terminals
	Input	1
	Output	5
	Ground	All Others

Dot Indicates Pin 1

### Materials

Solder Pad Termination	Au plating 30 - 60 μinches (76.2-152 μm) over 80-200 μinches (203-508 μm) Ni.
Lid	Fe-Ni-Co Alloy Electroless Nickel Plate (8-11% Phosphorus) 100-200 μinches Thick
Body	Al <sub>2</sub> O <sub>3</sub> Ceramic
Pb Free	

TOP VIEW

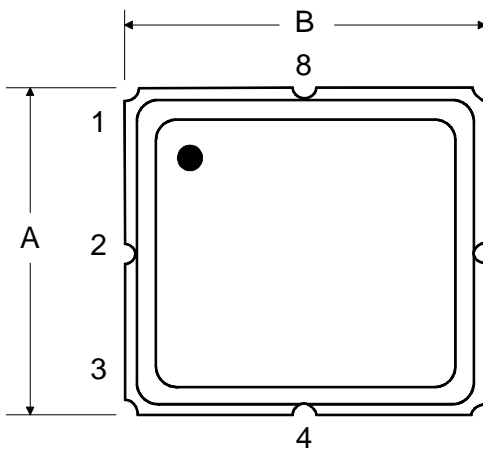

BOTTOM VIEW

