

EL5108, EL5308

450MHz Fixed Gain Amplifiers with Enable

FN7358
Rev 8.00
August 11, 2015

The EL5108 and EL5308 are fixed gain amplifiers with a bandwidth of 450MHz. This makes these amplifiers ideal for today's high speed video and monitor applications. They feature internal gain-setting resistors and can be configured in a gain of +1, -1 or +2. The same bandwidth is seen in both gain-of-1 and gain-of-2 applications.

The EL5108 and EL5308 also incorporate an enable and disable function to reduce the supply current to 25µA typical per amplifier. Allowing the \overline{CE} pin to float or applying a low logic level will enable the amplifier.

The EL5108 is offered in the 6 Ld SOT-23 and the industry-standard 8 Ld SOIC packages and the EL5308 is available in the 16 Ld SOIC and 16 Ld QSOP packages. All operate over the industrial temperature range of -40°C to +85°C.

Features

- Pb-free available (RoHS compliant)
- Gain selectable (+1, -1, +2)
- 450MHz -3dB BW ($A_V = -1, +1, +2$)
- 3.5mA supply current per amplifier
- Single and dual supply operation, from 5V to 12V
- Available in SOT-23 packages
- 350MHz, 1.5mA product available (EL5106 and EL5306)

Applications

- Battery powered equipment
- Handheld, portable devices
- Video amplifiers
- Cable drivers
- RGB amplifiers

Ordering Information

| PART NUMBER | PART MARKING | PACKAGE | PKG. DWG. # |
|--|--------------|--------------------------------|-------------|
| EL5108IW-T7* (No longer available or supported) | r | 6 Ld SOT-23 | P6.064A |
| EL5108IW-T7A*(No longer available or supported) | r | 6 Ld SOT-23 | P6.064A |
| EL5108IWZ-T7* (Note) (No longer available or supported) | BAGA | 6 Ld SOT-23 (Pb-free) | P6.064A |
| EL5108IWZ-T7A* (Note) (No longer available or supported) | BAGA | 6 Ld SOT-23 (Pb-free) | P6.064A |
| EL5108IS (No longer available or supported) | 5108IS | 8 Ld SOIC (150 mil) | MDP0027 |
| EL5108IS-T7* (No longer available or supported) | 5108IS | 8 Ld SOIC (150 mil) | MDP0027 |
| EL5108IS-T13* (No longer available or supported) | 5108IS | 8 Ld SOIC (150 mil) | MDP0027 |
| EL5108ISZ (Note) (No longer available or supported) | 5108ISZ | 8 Ld SOIC (150 mil) (Pb-free) | MDP0027 |
| EL5108ISZ-T7* (Note) (No longer available or supported) | 5108ISZ | 8 Ld SOIC (150 mil) (Pb-free) | MDP0027 |
| EL5108ISZ-T13* (Note) (No longer available or supported) | 5108ISZ | 8 Ld SOIC (150 mil) (Pb-free) | MDP0027 |
| EL5308IUZ (Note) | 5308IUZ | 16 Ld QSOP (150 mil) (Pb-free) | MDP0040 |
| EL5308IUZ-T7* (Note) | 5308IUZ | 16 Ld QSOP (150 mil) (Pb-free) | MDP0040 |
| EL5308IUZ-T13* (Note) | 5308IUZ | 16 Ld QSOP (150 mil) (Pb-free) | MDP0040 |

*Please refer to TB347 for details on reel specifications.

NOTE: These Intersil Pb-free plastic packaged products employ special Pb-free material sets, molding compounds/die attach materials, and 100% matte tin plate plus anneal (e3 termination finish, which is RoHS compliant and compatible with both SnPb and Pb-free soldering operations). Intersil Pb-free products are MSL classified at Pb-free peak reflow temperatures that meet or exceed the Pb-free requirements of IPC/JEDEC J STD-020.

Pinouts

**EL5108
(8 LD SOIC)
TOP VIEW**

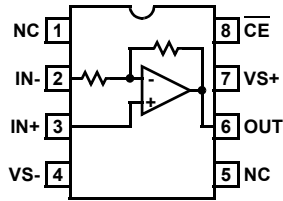

**EL5108
(6 LD SOT-23)
TOP VIEW**

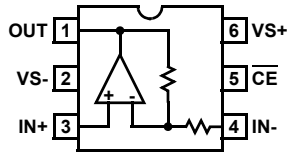

**EL5308
(16 LD SOIC, QSOP)
TOP VIEW**

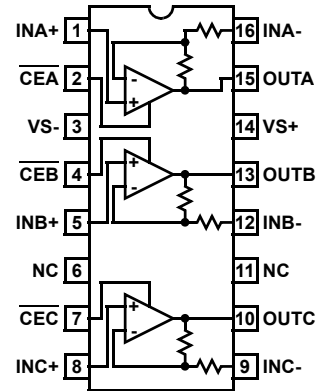

Absolute Maximum Ratings ($T_A = +25^\circ\text{C}$)

| | |
|--|--|
| Supply Voltage between V_{S+} and V_{S-} | 13.2V |
| Pin Voltages | $V_{S-} -0.5\text{V}$ to $V_{S+} +0.5\text{V}$ |
| Maximum Continuous Output Current | 50mA |
| Maximum Slewrate from V_{S+} to V_{S-} | 1V/ μs |

Thermal Information

| | |
|--------------------------------------|---|
| Storage Temperature | -65°C to $+150^\circ\text{C}$ |
| Ambient Operating Temperature | -40°C to $+85^\circ\text{C}$ |
| Operating Junction Temperature | $+125^\circ\text{C}$ |
| Power Dissipation | See Curves |
| Pb-free reflow profile | see link below |
| | http://www.intersil.com/pbfree/Pb-FreeReflow.asp |

CAUTION: Do not operate at or near the maximum ratings listed for extended periods of time. Exposure to such conditions may adversely impact product reliability and result in failures not covered by warranty.

IMPORTANT NOTE: All parameters having Min/Max specifications are guaranteed. Typical values are for information purposes only. Unless otherwise noted, all tests are at the specified temperature and are pulsed tests, therefore: $T_J = T_C = T_A$

Electrical Specifications $V_{S+} = +5\text{V}$, $V_{S-} = -5\text{V}$, $R_L = 150\Omega$, $T_A = +25^\circ\text{C}$ Unless Otherwise Specified.

| PARAMETER | DESCRIPTION | CONDITIONS | MIN | TYP | MAX | UNIT |
|-------------------------------|--|---|-----------|-----------|------|------------------------------|
| AC PERFORMANCE | | | | | | |
| BW | -3dB Bandwidth | $A_V = +1$ | | 440 | | MHz |
| | | $A_V = -1$ | | 445 | | MHz |
| | | $A_V = +2$ | | 450 | | MHz |
| BW1 | 0.1dB Bandwidth | $A_V = +2$ | | 40 | | MHz |
| SR | Slew Rate | $V_O = -2.5\text{V}$ to $+2.5\text{V}$, $A_V = +2$ | 3500 | 4500 | | V/ μs |
| t_S | 0.1% Settling Time | $V_{OUT} = -2.5\text{V}$ to $+2.5\text{V}$, $A_V = +2$ | | 10 | | ns |
| e_N | Input Voltage Noise | | | 2 | | nV/ $\sqrt{\text{Hz}}$ |
| i_N | Input Current Noise | $f = 2\text{kHz}$ | | 12 | | pA/ $\sqrt{\text{Hz}}$ |
| dG | Differential Gain Error (Note 1) | $A_V = +2$ | | 0.01 | | % |
| dP | Differential Phase Error (Note 1) | $A_V = +2$ | | 0.01 | | ° |
| DC PERFORMANCE | | | | | | |
| V_{OS} | Offset Voltage | | -8 | +3 | +8 | mV |
| $T_C V_{OS}$ | Input Offset Voltage Temperature Coefficient | Measured from T_{MIN} to T_{MAX} | | 5 | | $\mu\text{V}/^\circ\text{C}$ |
| A_E | Gain Error | $V_O = -3\text{V}$ to $+3\text{V}$, $R_L = 150\Omega$ | | 0.7 | 2.5 | % |
| R_F, R_G | Internal R_F and R_G | | | 325 | | Ω |
| INPUT CHARACTERISTICS | | | | | | |
| CMIR | Common Mode Input Range | | ± 3 | ± 3.3 | | V |
| $+I_{IN}$ | + Input Current | | | 2 | 8 | μA |
| R_{IN} | Input Resistance | at I_{N+} | | 0.7 | | M Ω |
| C_{IN} | Input Capacitance | | | 1 | | pF |
| OUTPUT CHARACTERISTICS | | | | | | |
| V_O | Output Voltage Swing | $R_L = 150\Omega$ to GND | ± 3.6 | ± 3.8 | | V |
| | | $R_L = 1\text{k}\Omega$ to GND | ± 3.8 | ± 4.0 | | V |
| I_{OUT} | Output Current | $R_L = 10\Omega$ to GND | 100 | 135 | | mA |
| SUPPLY | | | | | | |
| I_{SON} | Supply Current - Enabled (per amplifier) | No load, $V_{IN} = 0\text{V}$ | 3.18 | 3.7 | 4.35 | mA |
| I_{SOFF} | Supply Current - Disabled (per amplifier) | No load, $V_{IN} = 0\text{V}$ | | 9 | 25 | μA |
| PSRR | Power Supply Rejection Ratio | DC, $V_S = \pm 4.75\text{V}$ to $\pm 5.25\text{V}$ | | 75 | | dB |

Electrical Specifications $V_{S+} = +5V, V_{S-} = -5V, R_L = 150\Omega, T_A = +25^\circ C$ Unless Otherwise Specified. (Continued)

| PARAMETER | DESCRIPTION | CONDITIONS | MIN | TYP | MAX | UNIT |
|---------------|---|--------------------------|--------------|-----|--------------|---------|
| ENABLE | | | | | | |
| t_{EN} | Enable Time | | | 280 | | ns |
| t_{DIS} | Disable Time (Note 2) | | | 560 | | ns |
| I_{IHCE} | \overline{CE} Pin Input High Current | $\overline{CE} = V_{S+}$ | -1 | 5 | 25 | μA |
| I_{ILCE} | \overline{CE} Pin Input Low Current | $\overline{CE} = V_{S-}$ | +1 | | -1 | μA |
| V_{IHCE} | \overline{CE} Input High Voltage for Power-down | | $V_{S+} - 1$ | | | V |
| V_{ILCE} | \overline{CE} Input Low Voltage for Enable | | | | $V_{S+} - 3$ | V |

NOTES:

- Standard NTSC test, AC signal amplitude = 286mV_{P-P}, f = 3.58MHz
- Measured from the application of the \overline{CE} logic signal until the output voltage is at the 50% point between initial and final values

Pin Descriptions

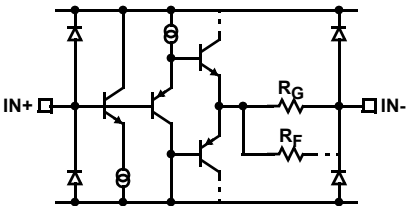
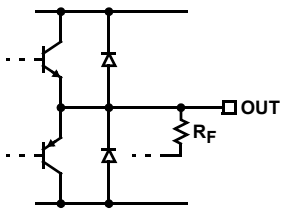
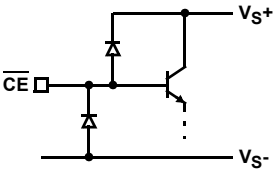
| EL5108 (SO8) | EL5108 (SOT23-6) | EL5308 (SO16, QSOP16) | PIN NAME | FUNCTION | EQUIVALENT CIRCUIT |
|--------------|------------------|-----------------------|-----------------|---------------------|--|
| 1, 5 | | 6, 11 | NC | Not connected | |
| 2 | 4 | 9, 12, 16 | IN- | Inverting input |  <p>CIRCUIT 1</p> |
| 3 | 3 | 1, 5, 8 | IN+ | Non-inverting input | (Reference Circuit 1) |
| 4 | 2 | 3 | VS- | Negative supply | |
| 6 | 1 | 10, 13, 15 | OUT | Output |  <p>CIRCUIT 2</p> |
| 7 | 6 | 14 | VS+ | Positive supply | |
| 8 | 5 | 2, 4, 7 | \overline{CE} | Chip enable |  <p>CIRCUIT 3</p> |

Typical Performance Curves

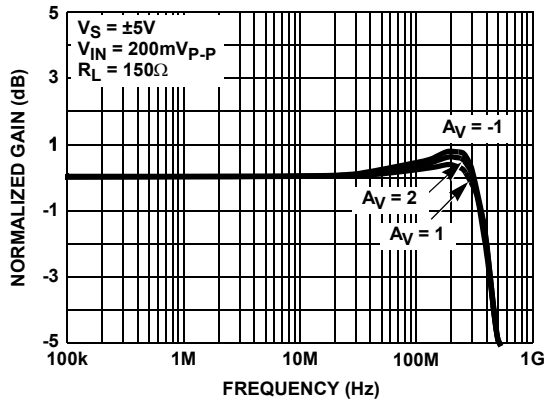

FIGURE 1. FREQUENCY RESPONSE

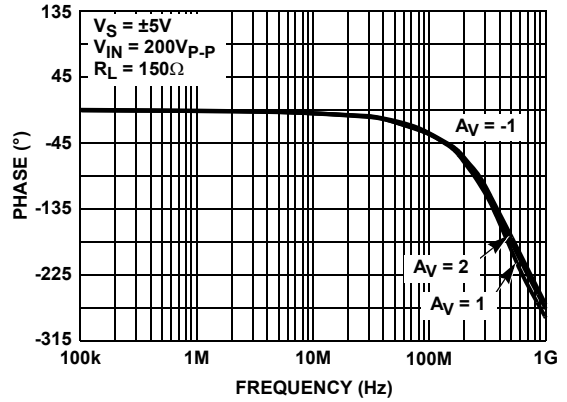

FIGURE 2. PHASE RESPONSE

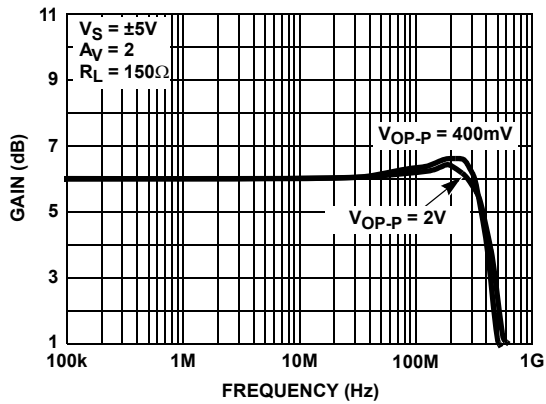

FIGURE 3. FREQUENCY RESPONSE vs OUTPUT VOLTAGE

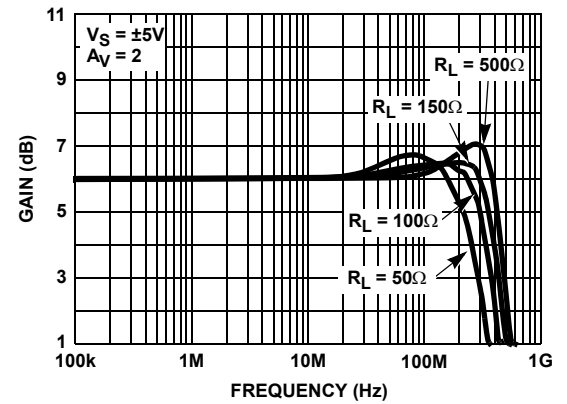

FIGURE 4. FREQUENCY RESPONSE vs R_L

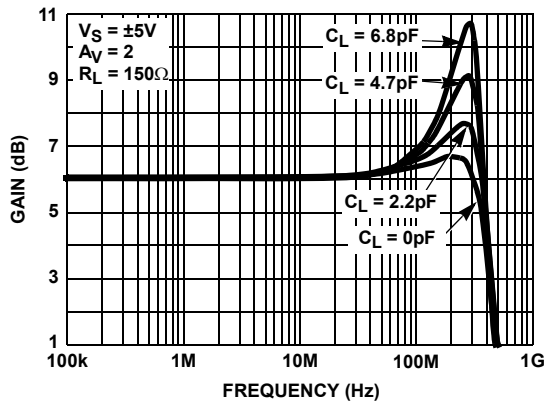

FIGURE 5. FREQUENCY RESPONSE FOR VARIOUS C_L

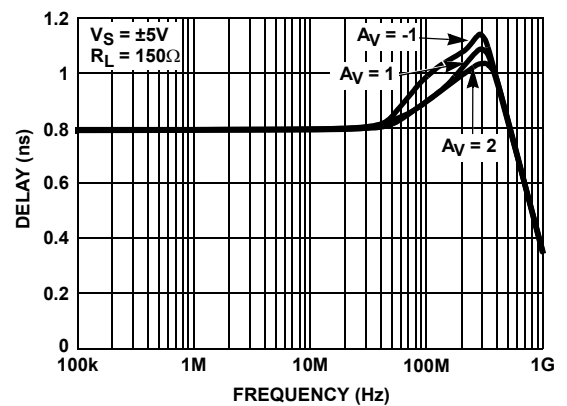

FIGURE 6. GROUP DELAY vs FREQUENCY

Typical Performance Curves (Continued)

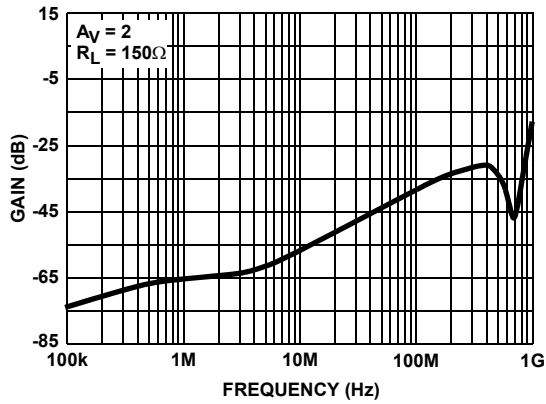

FIGURE 7. INPUT TO OUTPUT ISOLATION vs FREQUENCY (FOR DISABLE MODE)

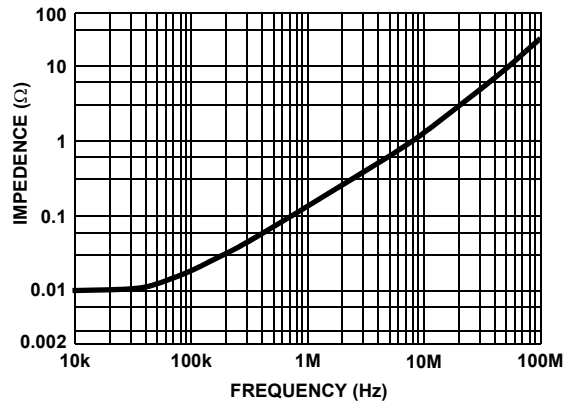

FIGURE 8. OUTPUT IMPEDANCE vs FREQUENCY

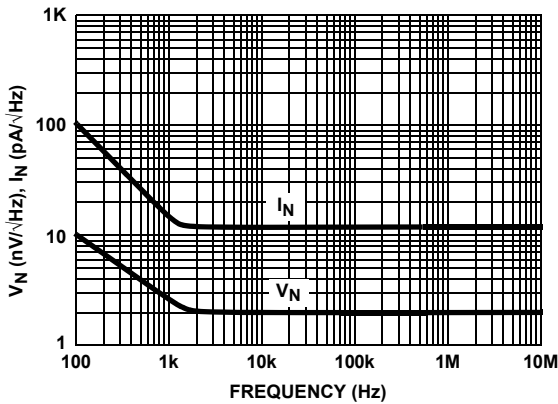

FIGURE 9. VOLTAGE AND CURRENT NOISE vs FREQUENCY

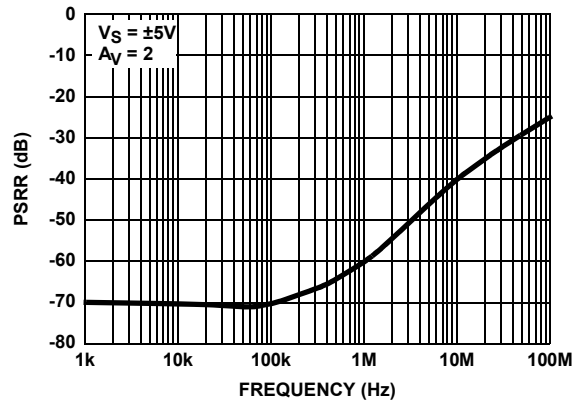

FIGURE 10. POWER SUPPLY REJECTION RATIO vs FREQUENCY

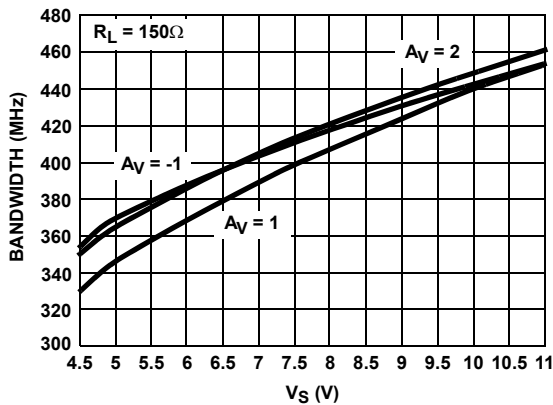

FIGURE 11. BANDWIDTH vs SUPPLY VOLTAGE

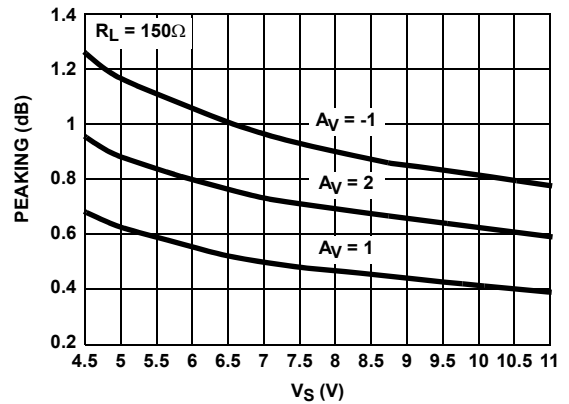

FIGURE 12. PEAKING vs SUPPLY VOLTAGE

Typical Performance Curves (Continued)

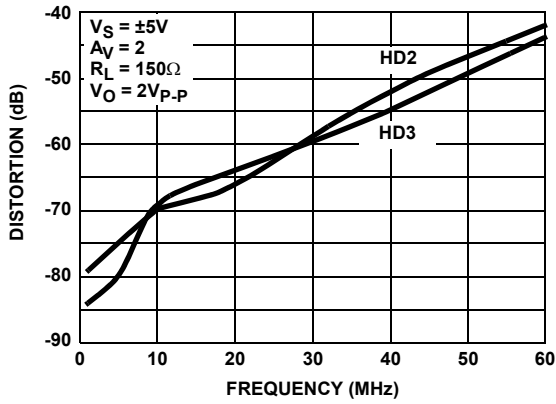

FIGURE 13. DISTORTION vs FREQUENCY

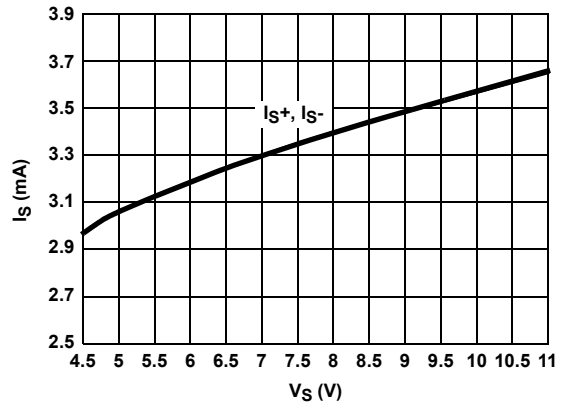

FIGURE 14. SUPPLY CURRENT vs SUPPLY VOLTAGE

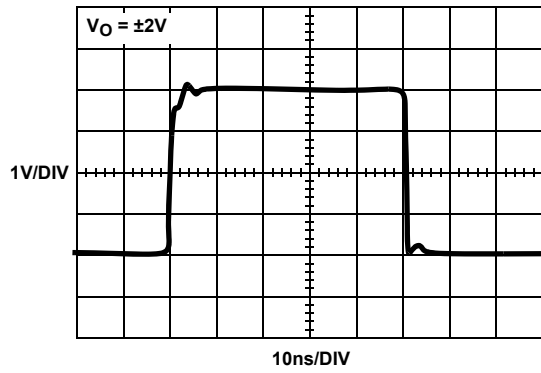

FIGURE 15. LARGE SIGNAL RESPONSE

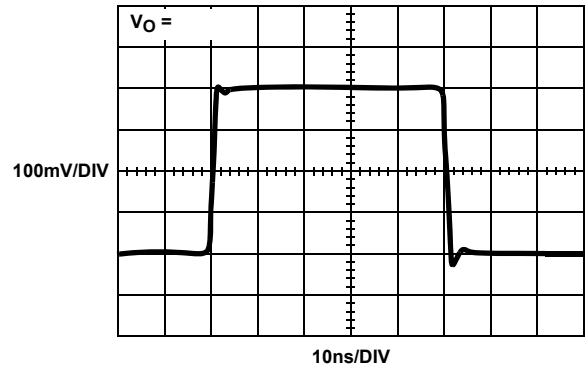

FIGURE 16. SMALL SIGNAL RESPONSE

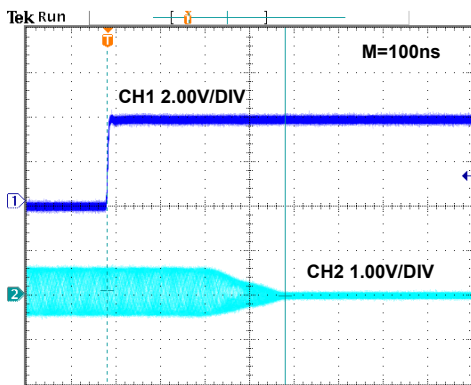

FIGURE 17. DISABLED RESPONSE

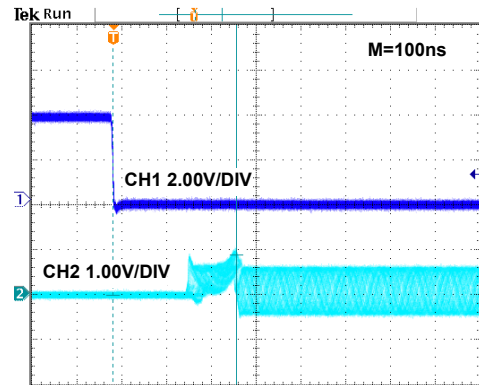

FIGURE 18. ENABLED RESPONSE

Typical Performance Curves (Continued)

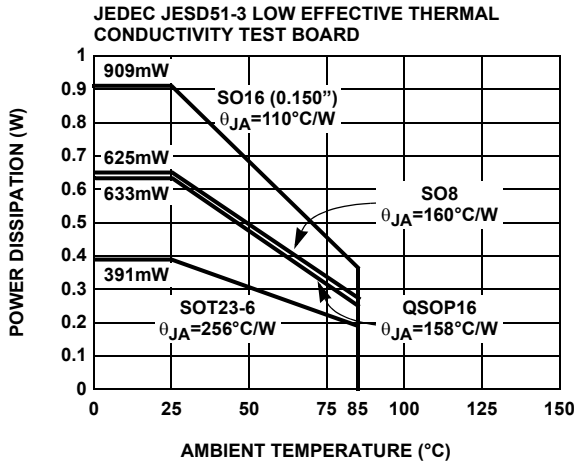

FIGURE 19. PACKAGE POWER DISSIPATION vs AMBIENT TEMPERATURE

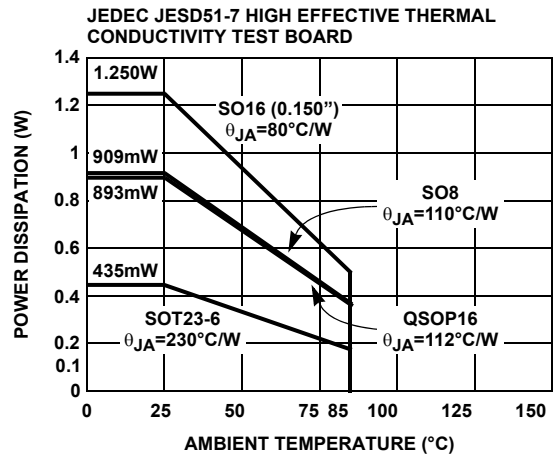

FIGURE 20. PACKAGE POWER DISSIPATION vs AMBIENT TEMPERATURE

Applications Information

Product Description

The EL5108 and EL5308 are fixed gain amplifiers that offer a wide -3dB bandwidth of 450MHz and a low supply current of 3.5mA per amplifier. They work with supply voltages ranging from a single 5V to 10V and they are also capable of swinging to within 1.2V of either supply on the output. These combinations of high bandwidth, low power, and high slew rate make the EL5108 and EL5308 the ideal choice for many low-power/high-bandwidth applications such as portable, handheld, or battery-powered equipment.

For varying bandwidth and higher gains, consider the EL5166 with 1GHz on a 9mA supply current or the EL5164 with 600MHz on a 3.5mA supply current. Versions include single, dual, and triple amp packages with 6 Ld SOT-23, 16 Ld QSOP, and 8 Ld SOIC or 16 Ld SOIC outlines.

Power Supply Bypassing and Printed Circuit Board Layout

As with any high frequency device, good printed circuit board layout is necessary for optimum performance. Low impedance ground plane construction is essential. Surface mount components are recommended, but if leaded components are used, lead lengths should be as short as possible. The power supply pins must be well bypassed to reduce the risk of oscillation. The combination of a 4.7µF tantalum capacitor in parallel with a 0.01µF capacitor has been shown to work well when placed at each supply pin.

Disable/Power-Down

The EL5108 and EL5308 amplifiers can be disabled and placing their outputs in a high impedance state. When disabled, the amplifier supply current is reduced to <25µA. The EL5108 and EL5308 are disabled when the \overline{CE} pin is pulled up to within 1V of the positive supply. Similarly, the amplifier is

enabled by floating or pulling its \overline{CE} pin to at least 3V below the positive supply. For ±5V supply, this means that the amplifier will be enabled when \overline{CE} is 2V or less, and disabled when \overline{CE} is above 4V. Although the logic levels are not standard TTL, this choice of logic voltages allow the EL5108 and EL5308 to be enabled by tying \overline{CE} to ground, even in 5V single supply applications. The \overline{CE} pins can be driven from CMOS outputs.

Gain Setting

The EL5108 and EL5308 are built with internal feedback and gain resistors. The internal feedback resistors have equal value; as a result, the amplifier can be configured into gain of +1, -1, and +2 without any external resistors. Figure 21 shows the amplifier in gain of +2 configuration. The gain error is ±2% maximum. Figure 22 shows the amplifier in gain-of-1 configuration. For gain of +1, IN+ and IN- should be connected together as shown in Figure 23. This configuration avoids the effects of any parasitic capacitance on the IN- pin. Since the internal feedback and gain resistors change with temperature and process, external resistor should not be used to adjust the gain settings.

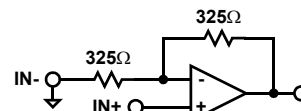

FIGURE 21. $A_v = +2$

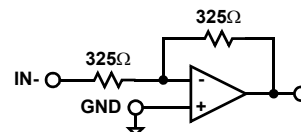

FIGURE 22. $A_v = -1$

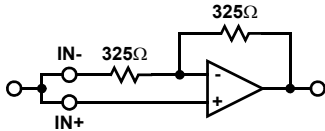

FIGURE 23. $A_V = +1$

Supply Voltage Range and Single-Supply Operation

The EL5108 and EL5308 have been designed to operate with supply voltages having a span of greater than or equal to 5V and less than 12V. In practical terms, this means that they will operate on dual supplies ranging from $\pm 2.5V$ to $\pm 5V$. With single-supply, they will operate from 5V to 10V.

As supply voltages continue to decrease, it becomes necessary to provide input and output voltage ranges that can get as close as possible to the supply voltages. The EL5108 and EL5308 have an input range which extends to within 2V of either supply. So, for example, on $\pm 5V$ supplies, the input range is about $\pm 3V$. The output range is also quite large, extending to within 1V of the supply rail. On a $\pm 5V$ supply, the output is therefore capable of swinging from $-4V$ to $+4V$. Single-supply output range is larger because of the increased negative swing due to the external pull-down resistor to ground. Figure 24 shows an AC-coupled, gain of +2, +5V single supply circuit configuration.

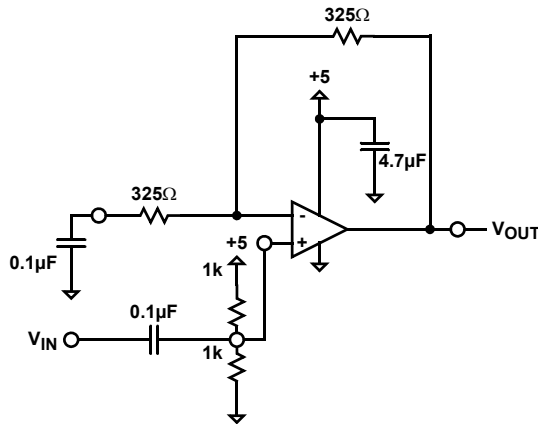

FIGURE 24.

Video Performance

For good video performance, an amplifier is required to maintain the same output impedance and the same frequency response as DC levels are changed at the output. This is especially difficult when driving a standard video load of 150Ω , because of the change in output current with DC level. Previously, good differential gain could only be achieved by running high idle currents through the output transistors (to reduce variations in output impedance). Special circuitry has been incorporated in the EL5108 and EL5308 to reduce the variation of output impedance with current output. This results in dG and dP specifications of 0.01% and 0.01° , while driving 150Ω at a gain of 2.

Output Drive Capability

In spite of its low 3.5mA of supply current per amplifier, the EL5108 and EL5308 are capable of providing a maximum of $\pm 130mA$ of output current.

Driving Cables and Capacitive Loads

When used as a cable driver, double termination is always recommended for reflection-free performance. For those applications, the back-termination series resistor will decouple the EL5108 and EL5308 from the cable and allow extensive capacitive drive. However, other applications may have high capacitive loads without a back-termination resistor. In these applications, a small series resistor (usually between 5Ω and 50Ω) can be placed in series with the output to eliminate most peaking.

Current Limiting

The EL5108 and EL5308 have no internal current-limiting circuitry. If the output is shorted, it is possible to exceed the Absolute Maximum Rating for output current or power dissipation, potentially resulting in the destruction of the device.

Power Dissipation

With the high output drive capability of the EL5108 and EL5308, it is possible to exceed the $+125^\circ C$ Absolute Maximum junction temperature under certain very high load current conditions. Generally speaking when R_L falls below about 25Ω , it is important to calculate the maximum junction temperature (T_{JMAX}) for the application to determine if power supply voltages, load conditions, or package type need to be modified for the EL5108 and EL5308 to remain in the safe operating area. These parameters are calculated as follows:

$$T_{JMAX} = T_{MAX} + (\theta_{JA} \times n \times PD_{MAX})$$

where:

T_{MAX} = Maximum ambient temperature

θ_{JA} = Thermal resistance of the package

n = Number of amplifiers in the package

PD_{MAX} = Maximum power dissipation of each amplifier in the package

PD_{MAX} for each amplifier can be calculated as follows:

$$PD_{MAX} = (2 \times V_S \times I_{SMAX}) + \left[(V_S - V_{OUTMAX}) \times \frac{V_{OUTMAX}}{R_L} \right]$$

where:

V_S = Supply voltage

I_{SMAX} = Maximum supply current of 1A

V_{OUTMAX} = Maximum output voltage (required)

R_L = Load resistance

Revision History

The revision history provided is for informational purposes only and is believed to be accurate, but not warranted. Please go to the web to make sure that you have the latest revision.

| DATE | REVISION | CHANGE |
|-----------------|----------|--|
| August 11, 2015 | FN7358.8 | Updated Ordering Information table on page 1. Added Revision History and About Intersil sections. Replaced package outline drawing MDP0038 with P6.064A because MDP0038 is no longer being used. |

About Intersil

Intersil Corporation is a leading provider of innovative power management and precision analog solutions. The company's products address some of the largest markets within the industrial and infrastructure, mobile computing and high-end consumer markets.

For the most updated datasheet, application notes, related documentation and related parts, please see the respective product information page found at www.intersil.com.

You may report errors or suggestions for improving this datasheet by visiting www.intersil.com/ask.

Reliability reports are also available from our website at www.intersil.com/support

Small Outline Package Family (SO)

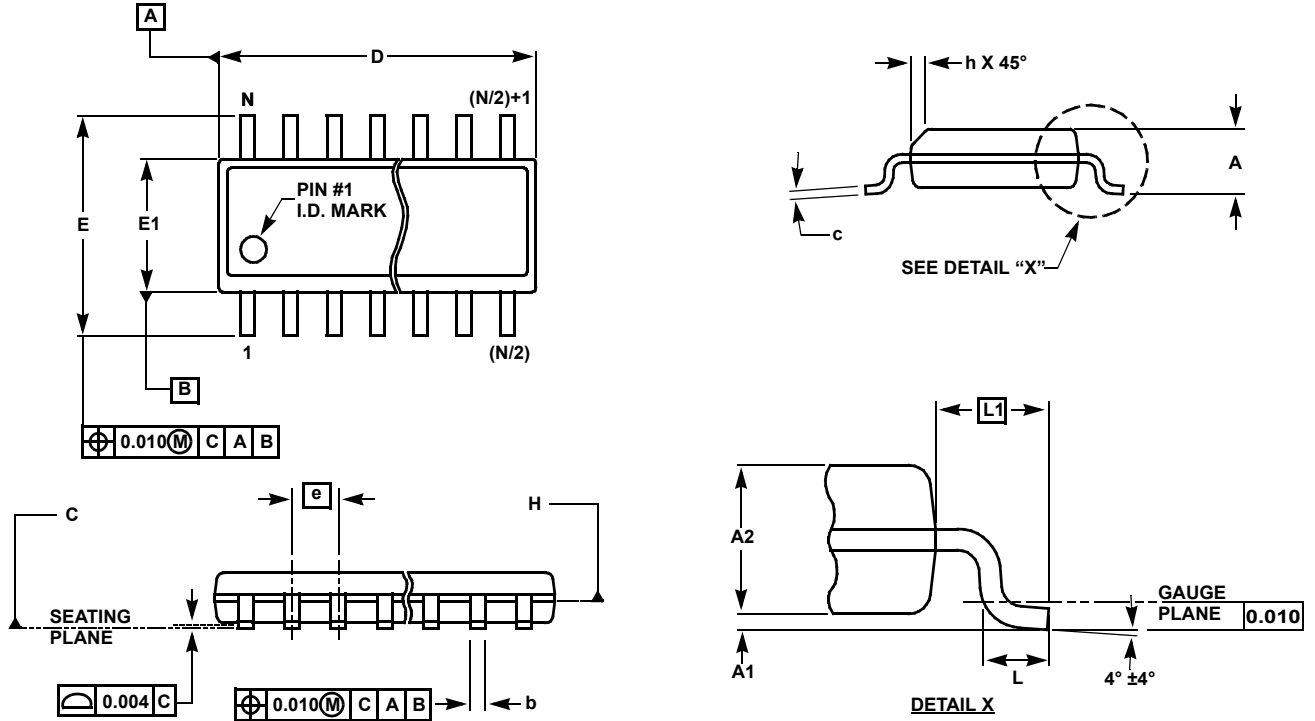

MDP0027

SMALL OUTLINE PACKAGE FAMILY (SO)

| SYMBOL | INCHES | | | | | | | TOLERANCE | NOTES |
|--------|--------|-------|---------------|------------------------|---------------|---------------|---------------|-----------|-------|
| | SO-8 | SO-14 | SO16 (0.150") | SO16 (0.300") (SOL-16) | SO20 (SOL-20) | SO24 (SOL-24) | SO28 (SOL-28) | | |
| A | 0.068 | 0.068 | 0.068 | 0.104 | 0.104 | 0.104 | 0.104 | MAX | - |
| A1 | 0.006 | 0.006 | 0.006 | 0.007 | 0.007 | 0.007 | 0.007 | ±0.003 | - |
| A2 | 0.057 | 0.057 | 0.057 | 0.092 | 0.092 | 0.092 | 0.092 | ±0.002 | - |
| b | 0.017 | 0.017 | 0.017 | 0.017 | 0.017 | 0.017 | 0.017 | ±0.003 | - |
| c | 0.009 | 0.009 | 0.009 | 0.011 | 0.011 | 0.011 | 0.011 | ±0.001 | - |
| D | 0.193 | 0.341 | 0.390 | 0.406 | 0.504 | 0.606 | 0.704 | ±0.004 | 1, 3 |
| E | 0.236 | 0.236 | 0.236 | 0.406 | 0.406 | 0.406 | 0.406 | ±0.008 | - |
| E1 | 0.154 | 0.154 | 0.154 | 0.295 | 0.295 | 0.295 | 0.295 | ±0.004 | 2, 3 |
| e | 0.050 | 0.050 | 0.050 | 0.050 | 0.050 | 0.050 | 0.050 | Basic | - |
| L | 0.025 | 0.025 | 0.025 | 0.030 | 0.030 | 0.030 | 0.030 | ±0.009 | - |
| L1 | 0.041 | 0.041 | 0.041 | 0.056 | 0.056 | 0.056 | 0.056 | Basic | - |
| h | 0.013 | 0.013 | 0.013 | 0.020 | 0.020 | 0.020 | 0.020 | Reference | - |
| N | 8 | 14 | 16 | 16 | 20 | 24 | 28 | Reference | - |

Rev. M 2/07

NOTES:

1. Plastic or metal protrusions of 0.006" maximum per side are not included.
2. Plastic interlead protrusions of 0.010" maximum per side are not included.
3. Dimensions "D" and "E1" are measured at Datum Plane "H".
4. Dimensioning and tolerancing per ASME Y14.5M-1994

Package Outline Drawing

P6.064A

6 LEAD SMALL OUTLINE TRANSISTOR PLASTIC PACKAGE

Rev 0, 2/10



NOTES:

1. Dimensions are in millimeters.
Dimensions in () for Reference Only.
2. Dimensioning and tolerancing conform to ASME Y14.5M-1994.
3. Dimension is exclusive of mold flash, protrusions or gate burrs.
4. Foot length is measured at reference to gauge plane.
5. This dimension is measured at Datum "H".
6. Package conforms to JEDEC MO-178AA.

Quarter Size Outline Plastic Packages Family (QSOP)



MDP0040

QUARTER SIZE OUTLINE PLASTIC PACKAGES FAMILY

| SYMBOL | INCHES | | | TOLERANCE | NOTES |
|--------|--------|--------|--------|-------------|-------|
| | QSOP16 | QSOP24 | QSOP28 | | |
| A | 0.068 | 0.068 | 0.068 | Max. | - |
| A1 | 0.006 | 0.006 | 0.006 | ± 0.002 | - |
| A2 | 0.056 | 0.056 | 0.056 | ± 0.004 | - |
| b | 0.010 | 0.010 | 0.010 | ± 0.002 | - |
| c | 0.008 | 0.008 | 0.008 | ± 0.001 | - |
| D | 0.193 | 0.341 | 0.390 | ± 0.004 | 1, 3 |
| E | 0.236 | 0.236 | 0.236 | ± 0.008 | - |
| E1 | 0.154 | 0.154 | 0.154 | ± 0.004 | 2, 3 |
| e | 0.025 | 0.025 | 0.025 | Basic | - |
| L | 0.025 | 0.025 | 0.025 | ± 0.009 | - |
| L1 | 0.041 | 0.041 | 0.041 | Basic | - |
| N | 16 | 24 | 28 | Reference | - |

Rev. F 2/07

NOTES:

1. Plastic or metal protrusions of 0.006" maximum per side are not included.
2. Plastic interlead protrusions of 0.010" maximum per side are not included.
3. Dimensions "D" and "E1" are measured at Datum Plane "H".
4. Dimensioning and tolerancing per ASME Y14.5M-1994.

© Copyright Intersil Americas LLC 2002-2015. All Rights Reserved.
 All trademarks and registered trademarks are the property of their respective owners.

For additional products, see www.intersil.com/en/products.html

Intersil products are manufactured, assembled and tested utilizing ISO9001 quality systems as noted in the quality certifications found at www.intersil.com/en/support/qualandreliability.html

Intersil products are sold by description only. Intersil may modify the circuit design and/or specifications of products at any time without notice, provided that such modification does not, in Intersil's sole judgment, affect the form, fit or function of the product. Accordingly, the reader is cautioned to verify that datasheets are current before placing orders. Information furnished by Intersil is believed to be accurate and reliable. However, no responsibility is assumed by Intersil or its subsidiaries for its use; nor for any infringements of patents or other rights of third parties which may result from its use. No license is granted by implication or otherwise under any patent or patent rights of Intersil or its subsidiaries.

For information regarding Intersil Corporation and its products, see www.intersil.com