

TS441165



Description

The TS441165 is an analog delay-on-make timer with a normally closed solid-state output. Unlike an interval timer, the load is energized prior to and during the time delay period. It can be used as a faster starting interval time delay when S1 is closed upon application of input voltage.

Operation (Delay-on-Make NC)

Upon application of input voltage, the load is energized immediately. When the initiate switch is closed, the time delay begins. At the end of the time delay, the load de-energizes.

Reset: When the initiate switch is reopened, the load again energizes and the time delay is reset. Removing input voltage resets the time delay and output.

Features & Benefits

FEATURES	BENEFITS
Analog circuitry	Repeat Accuracy + / - 2%
Compact, low cost design	Allows flexibility for OEM applications
1A steady, 10A inrush solid-state output	Provides 100 million operations in typical conditions.
Load energized prior to and during time delay	Faster operation
Totally solid state and encapsulated	No moving parts to arc and wear out over time and encapsulated to protect against shock, vibration, and humidity
Normally closed output	Can be used as a faster starting interval time delay

Wiring Diagram

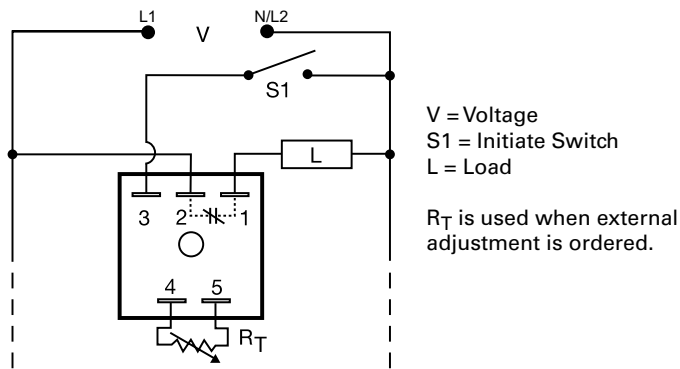



Accessories

- 

P1004-XX, P1004-XX-X Versa-Pot
Panel mountable, industrial potentiometer recommended for remote time delay adjustment.
- 

P1023-6 Mounting bracket
The 90° orientation of mounting slots makes installation/removal of modules quick and easy.
- 

P0700-7 Versa-Knob
Designed for 0.25 in. (6.35 mm) shaft of Versa-Pot. Semi-gloss industrial black finish.
- 

P1015-64 (AWG 14/16) Female Quick Connect
These 0.25 in. (6.35 mm) female terminals are constructed with an insulator barrel to provide strain relief.
- 

P1015-18 Quick Connect to Screw Adapter
Screw adapter terminal designed for use with all modules with 0.25 in. (6.35 mm) male quick connect terminals.

Time Delay Relays

Dedicated - Delay-on-Make, Normally Closed

TS441165

Accessories



C103PM (AL) DIN Rail
35 mm aluminum DIN rail available in a 36 in. (91.4 cm) length.



P1023-20 DIN Rail Adapter
Allows module to be mounted on a 35 mm DIN type rail with two #10 screws.



VTP(X)(X) Plug-on Adjustment Module
Mounts on modules with in-line adjustment terminals. Rated at 0.25W at 55°C. Available in resistance values from 5KΩ to 5MΩ.

Selection Table for VTP Plug-on Adjustment Accessory

Time Delay	VTP P/N
1 - 0.05-3s	VTP4B
2 - 0.5-60s	VTP4F
3 - 2-180s	VTP4J
4 - 5-600s	VTP5N

Selection Guide

R _T Selection Chart				
Desired Time Delay*				R _T
Seconds				
1	2	3	4	Megohm
0.05	0.5	2	5	0.0
0.5	10	30	60	0.5
1.0	20	60	120	1.0
1.5	30	90	180	1.5
2.0	40	120	240	2.0
2.5	50	150	300	2.5
3.0	60	180	360	3.0
			420	3.5
			480	4.0
			540	4.5
			600	5.0

* When selecting an external R_T add at least 20% for tolerance of unit and the R_T.

Function Diagram

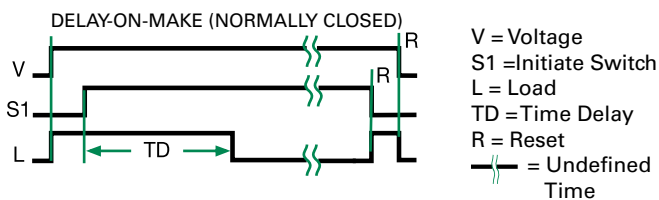

Specifications

Time Delay

Type

Analog circuitry

Range

165s

Adjustment

Fixed

Repeat Accuracy

±2% or 20ms, whichever is greater; under fixed conditions

Tolerance

(Factory Calibration)

≤ ±10%

Time Delay vs Temp. & Voltage

≤ ±10%

Recycle Time

≤ 150ms

Input

Voltage

120VAC

Tolerance

±20%

AC Line Frequency

50/60 Hz

Output

Type

Solid state

Form

NC, closed during timing

Maximum Load Current

1A steady state, 10A inrush at 60°C

Voltage Drop

≅ 2.5V @ 1A

Protection

Circuitry

Encapsulated

Dielectric Breakdown

≥ 2000V RMS terminals to mounting surface

Insulation Resistance

≥ 100 MΩ

Mechanical

Mounting

Surface mount with one #10 (M5 x 0.8) screw

Dimensions

H 50.8 mm (2.0"); **W** 50.8 mm (2.0");
D 30.7 mm (1.21")

Termination

0.25 in. (6.35 mm) male quick connect terminals

Environmental

Operating/Storage

Temperature

-40° to 75°C / -40° to 85°C

Humidity

95% relative, non-condensing

Weight

≅ 2.4 oz (68 g)