

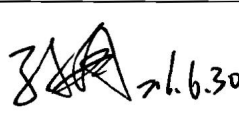

# Product Specification

**Product Name: T150NB02D01**

<b>Customer</b>
<b>Approved by Customer</b>
<b>Approved Date:</b>

Designed By	Checked by	Approved By	
		R&D	QA
 6.6.30	 2016.6.30	 6.30	 6/30/16

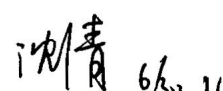
---

## CONTENT

<b>REVISION RECORD</b> .....	<b>3</b>
<b>1 OVERVIEW</b> .....	<b>4</b>
<b>2 FEATURES</b> .....	<b>4</b>
<b>3 GENERAL INFORMATION</b> .....	<b>4</b>
<b>4 MECHANICAL DRAWING</b> .....	<b>5</b>
<b>5 MODULE INTERFACE</b> .....	<b>6</b>
5.1 TFT PIN DESCRIPTION.....	6
5.2 LED PIN DESCRIPTION.....	7
5.3 BACK-LIGHT UNIT.....	7
<b>6 ABSOLUTE MAXIMUM RATING</b> .....	<b>8</b>
<b>7 ELECTRICAL CHARACTERISTICS</b> .....	<b>9</b>
7.1 DC ELECTRICAL CHARACTERISTICS.....	9
7.2 AC ELECTRICAL CHARACTERISTICS.....	11
<b>8 POWER ON/OFF SEQUENCE</b> .....	<b>12</b>
<b>9 OPTICAL CHARACTERISTICS</b> .....	<b>13</b>
<b>10 PACKAGE SPECIFICATION</b> .....	<b>16</b>
<b>11 RELIABILITY</b> .....	<b>17</b>
<b>12 ILLUSTRATION OF PRODUCT NAME</b> .....	<b>18</b>
<b>13 PRECAUTIONS FOR OPERATION AND STORAGE</b> .....	<b>18</b>
13.1 PRECAUTIONS FOR OPERATION.....	19
13.2 SOLDERING.....	19
13.3 PRECAUTIONS FOR STORAGE.....	19
13.4 WARRANTY PERIOD.....	19



## 1 Overview

The specifications is a transmissive type color active matrix liquid crystal display (LCD) which uses amorphous thin film transistor (TFT) as switching devices. This product is composed of a TFT LCD panel, driver IC, FPC, and a backlight unit.

## 2 Features

- Panel Size: 15.0 inch
- Number of Pixels /Resolution: 1024×RGB×768
- Interface: LVDS
- RoHS and Halogen-Free Compliance
- Applications: Multimedia application and other hand application

## 3 General Information

NO.	ITEM	SPECIFICATION	UNIT
1	Dot Matrix	1024(W)×768(H)	Pixels
2	Dot Pitch	0.297(W)×0.297 (H)	mm
3	Active Area	304.128(W)×228.096(H)	mm
4	Module Size	326.5(W)×253.5(H)×12(T)	mm
5	Viewing Angle	6 O'clock	mm
6	Module Weight	960(MAX)	gram

4 Mechanical Drawing

Front side

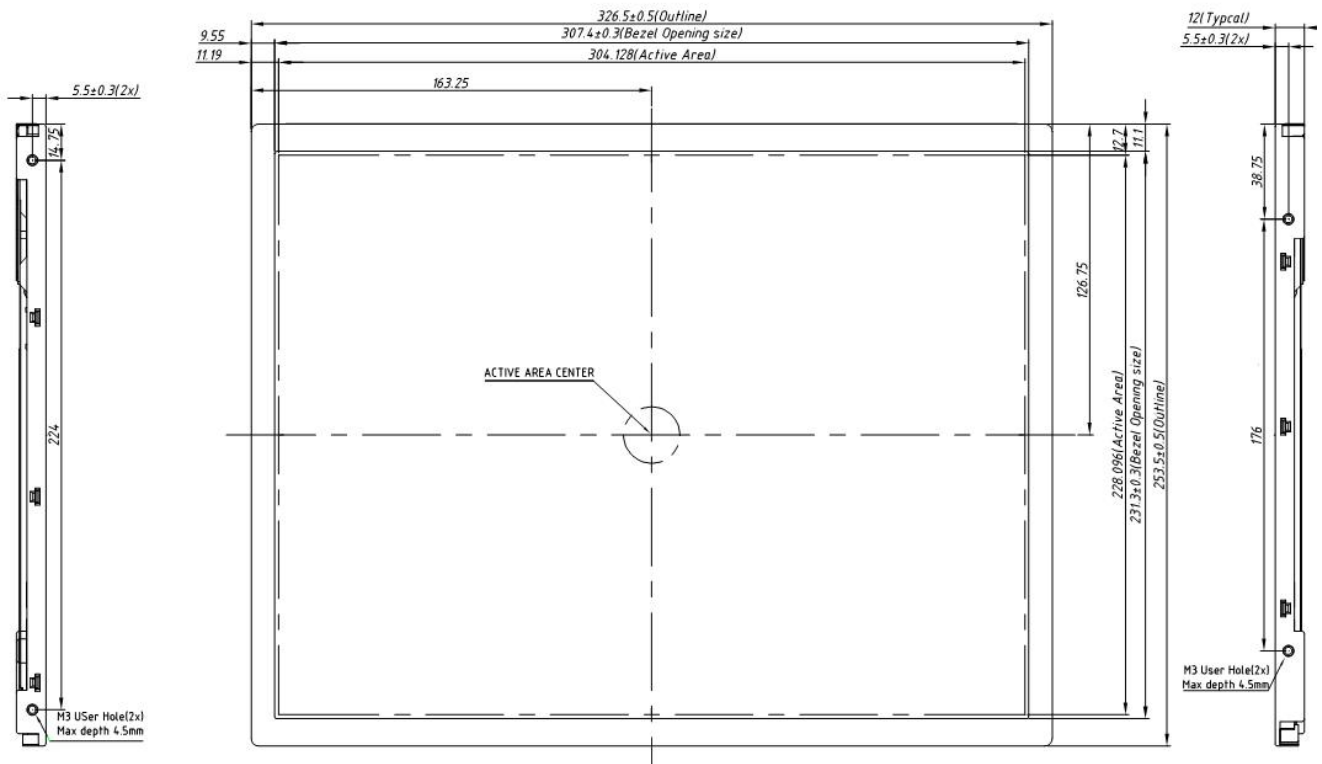

Back side

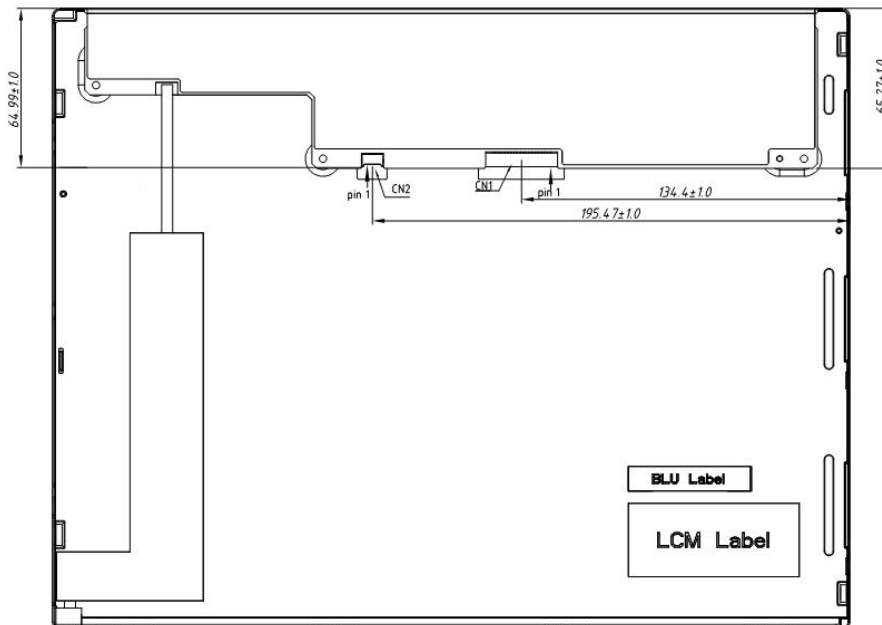

## 5 Module Interface

### 5.1 TFT PIN Description

Item	Description
Type / Part Number	MSB240420HD
Mating Model Number	P240420 or compatible

NO.	Symbol	Description
1	VDD	Power Supply,3.3V(typ)
2	VDD	Power Supply,3.3V(typ)
3	VSS	Ground
4	REV	Reverse Scan selection
5	Rin1-	-LVDS differential data input(R0-R5,G0)
6	Rin1+	+LVDS differential data input(R0-R5,G0)
7	VSS	Ground
8	Rin2-	-LVDS differential data input
9	Rin2+	+LVDS differential data input
10	VSS	Ground
11	Rin3-	-LVDS differential data input
12	Rin3+	+LVDS differential data input
13	VSS	Ground
14	ClkIN-	-LVDS differential clock input
15	ClkIN+	+LVDS differential clock input
16	GND	Ground
17	Rin4-	-LVDS differential data input
18	Rin4+	+LVDS differential data input
19	VSS	Ground
20	NC	Not connect

NOTE: REV drawing

REV = LOW/NC

REV = High



**5.2 LED PIN Description**

Connector Name/Designation	LED Driver Connector
Manufacturer	STM or compatible
Connector Model Number	MSB24038P5A or compatible
Mating Model Number	P24038P5A or compatible

**LED Connector Pin Assignment**

Pin #	Symbol	Signal Name
1	VCC	12V
2	GND	GND
3	Enable	5V-On / 0V-Off
4	Dimming	PWM Dimming or Analog Dimming
5	NC	NC

**5.3 Back-Light Unit**

Symbol	Parameter	Min.	Typ.	Max.	Units	Condition	
VLED	LED Input	10.8	12	12.6	[V]	Ta=25 Note B	
PLED	LED Power Consumption	-	-	7.5	W	Ta=25°C Note B	
VLED_PWM	PWM Signal Voltage	High	4.5	5	5.5	V	Ta=25°C
		Low			0.8	V	
F <sub>PWM</sub>	PWM dimming Frequency	200	-	20K	Hz	Ddim ≥ 5%	
VLED_EN	LED Enable Voltage	High	2.0	5	5.5	V	-
		Low			0.8	V	
LT	LED Life Time	30,000	-	-	Hours	Ta=25°C Note A	

Note A: The LED life time define as the estimated time to 50% degradation of initial luminous.

Note B: A higher LED power supply voltage will result in better power efficiency. Keep the VLED between 12V and 12.6V is strongly recommended.

**LED Rush Current Measure Condition**

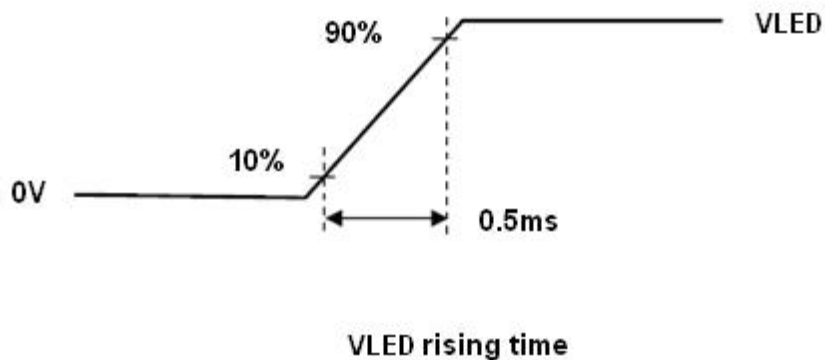

## 6 Absolute Maximum Rating

### Electrical Absolute Rating

Item	Symbol	Min.	Max.	Unit
Supply voltage	VDD	-0.5	5.0	V
Operating temperature	TOP	-20	70	°C
Operating Humidity	HOP	10	85	%RH
Storage temperature	TST	-30	80	°C
Humidity	HST	10	95	%RH



## 7 Electrical Characteristics

### 7.1 DC Electrical Characteristics

Symbol	Parameter	Min.	Typ.	Max.	Units	Condition
VDD	Logic/LCD Drive Voltage	3.0	3.3	3.6	[V]	-
IDD	VDD Current	-	0.25	-	[A]	3.3V/Black pattern
PDD	VDD Power	-	-	1.3	[W]	Black Pattern, 60Hz
Irush	Rush Current	-	-	3	[A]	Note1
VDDrp	Allowable Logic/LCD Drive Ripple Voltage	-	-	200	[mV]p-p	Note 2

Note 1.Measure Condition

VDD rising time

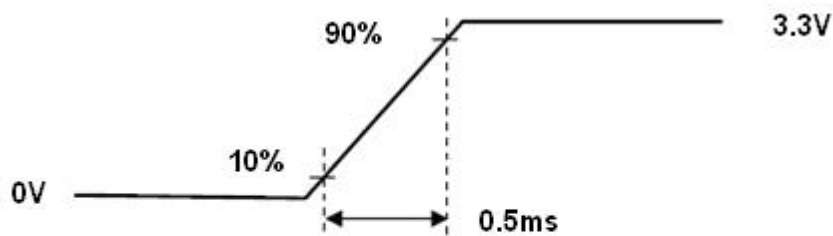

VDD rising time

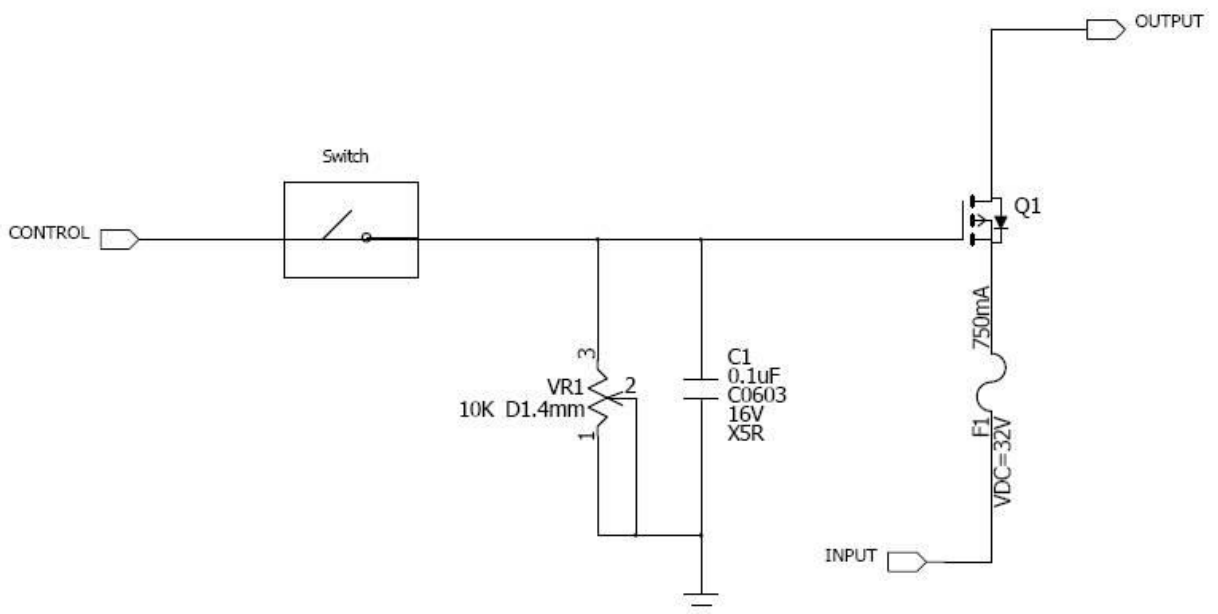

Note 2. VDD Power Dip Condition

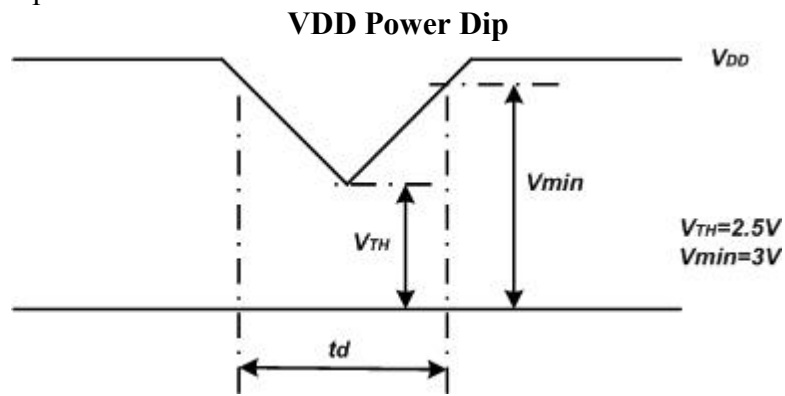

If  $V_{TH} < V_{DD} \leq V_{min}$  , then  $t_d \leq 10ms$  ; When the voltage return to normal our panel must revive automatically.

7.2 AC Electrical Characteristics

7.2.1 Timing Characteristics

Interface Timings

Synchronization Method: DE only

Parameter	Symbol	Unit	Min.	Typ.	Max.
LVDS Clock Frequency <single >	fdck	MHz	50	65	80
H Total Time	Thp	clocks	1056	1344	1720
H Active Time	HA	clocks	1024	1024	1024
H Front Porch	Thfp	clocks	-	48	-
H Sync Pulse Width	HSPW	clocks	-	32	-
H Back Porch	Thbp	clocks	-	240	-
H Frequency	fh	kHz	46.32	48.36	59.40
V Total Time	Tvp	lines	772	806	990
V Active Time	VA	lines	768	768	768
V Front Porch	Tvfp	lines	-	3	-
V Sync Pulse Width	VSPW	lines	-	12	-
V Back Porch	Tvbp	lines	-	23	-
V Frequency	fv	Hz		60	

Note: H Blank area and V Blank area can not be changed at every frame

7.2.2 Timing Diagram of Interface Signal

Timing Characteristics

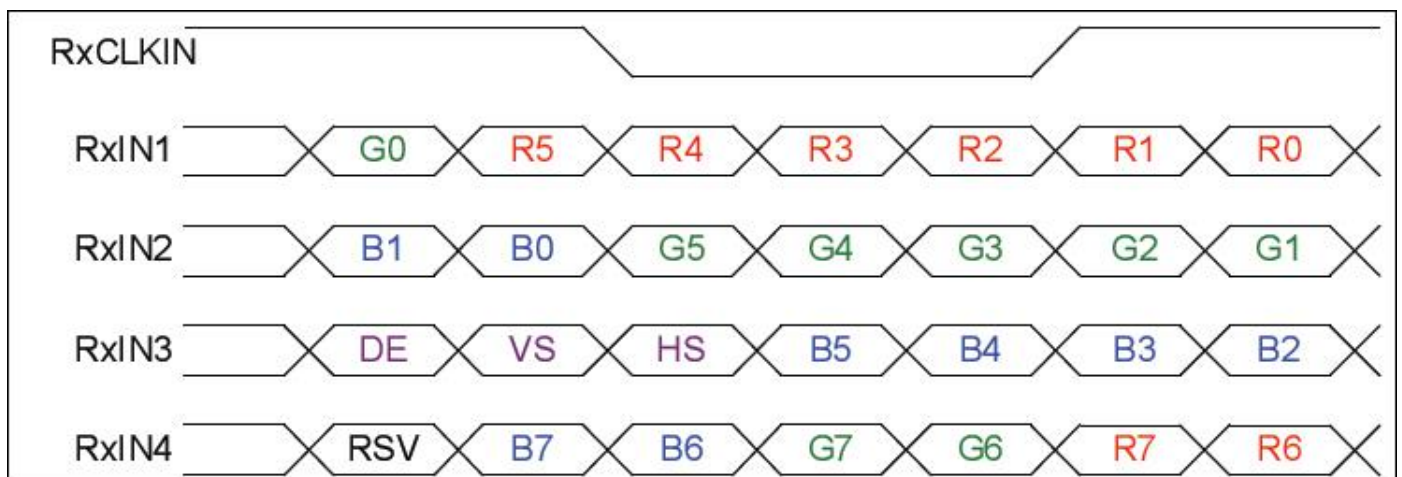

### 8 Power ON/OFF Sequence

VDD power on/off sequence is as follows. Interface signals are also shown in the chart. Signals from any system shall be Hi-Z state or low level when VDD is off.

**Power Sequence**

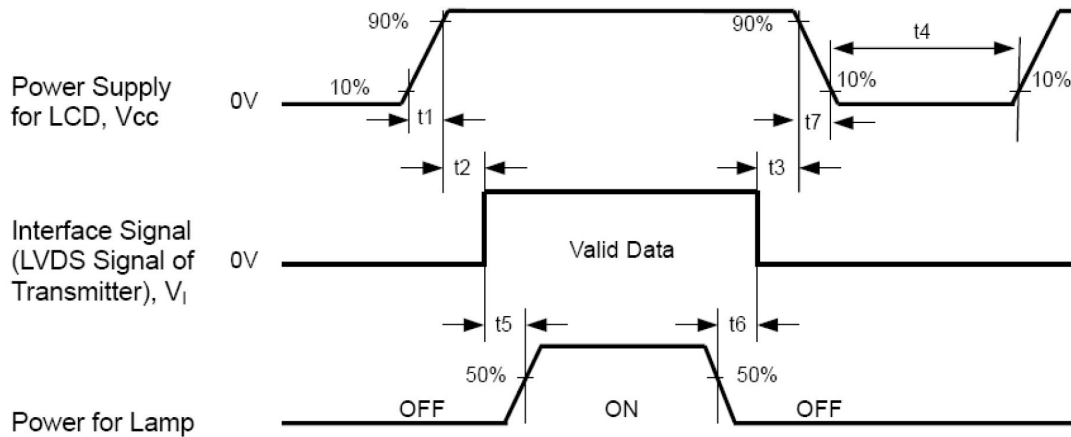

**Power Sequencing Requirements**

Parameter	Symbol	Unit	min	Typ.	max
VDD Rise Time	T1	ms	0.5	-	10
VDD Good to Signal Valid	T2	ms	0	-	20
Signal Disable to Power Down	T3	ms	0	-	1000
Power Off	T4	ms	1000	-	
Signal Valid to Backlight On	T5	ms	300	-	
Backlight Off to Signal Disable	T6	ms	200	-	
VDD Fall Time	T7	ms	0	-	100

9 Optical characteristics

Item	Conditions	Min.	Typ.	Max.	Unit	Note			
Viewing Angle (CR>10)	Horizontal	$\theta_L$	70	80	-	degree	(1),(2),(3)		
		$\theta_R$	70	80	-				
	Vertical	$\theta_T$	70	80	-				
		$\theta_B$	60	80	-				
Contrast Ratio	Center	450	800	-	-	(1),(2),(4)			
Response Time	Rising	-	5	-	ms	(1),(2),(5)			
	Falling	-	11	-	ms				
	Rising + Falling	-	16	-	ms				
Color Chromaticity (CIE1931)	NTSC		-	70	-	%	(1),(2)		
	Red	x	Typ. -0.03	0.625	Typ. +0.03	-	(1),(2)		
	Red	y		0.352		-			
	Green	x		0.315		-			
	Green	y		0.63		-			
	Blue	x		0.149		-			
	Blue	y		0.067		-			
	White	x		0.255		0.305		0.355	-
	White	y		0.275		0.325		0.375	-
White Luminance	Center	350	420	-	cd/m <sup>2</sup>	(1),(2),(6)			
Luminance Uniformity	9Points	75	80	-	%	(1),(2),(6)			

Note (1) Measurement Setup:

The LCD module should be stabilized at given temperature(25 ) for 15 minutes to Avoid abrupt temperature change during measuring. In order to stabilize the luminance, the measurement should be executed after lighting backlight for 15 minutes in a windless room.

**Measurement Setup**

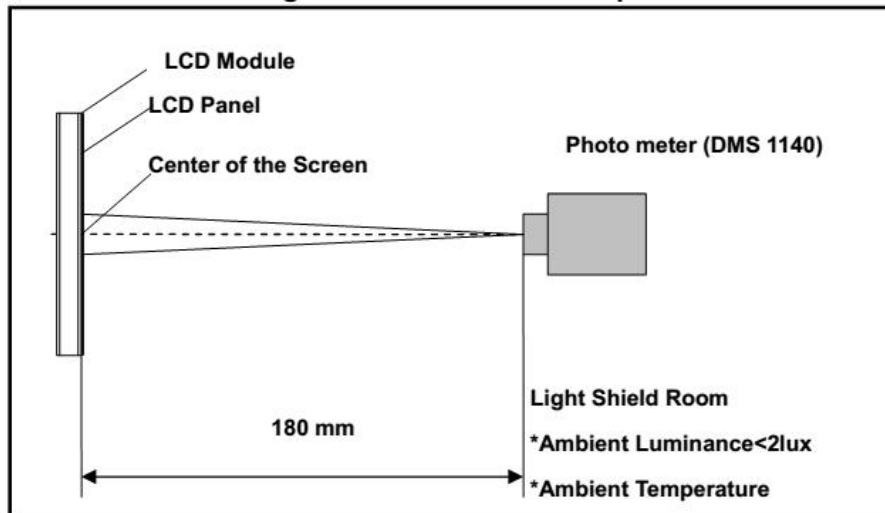

Note (2) The LED input parameter setting as:

VLED: 12V;

PWM\_LED: Duty 100 %

Note (3) Definition of Viewing Angle

Definition of Viewing Angle

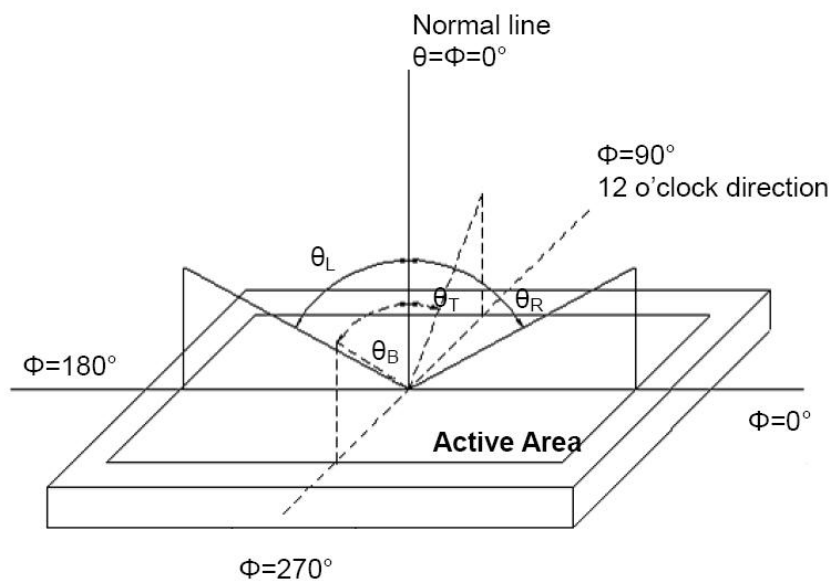

Note (4) Definition Of Contrast Ratio (CR)

The contrast ratio can be calculated by the following expression

$$\text{Contrast Ratio (CR)} = L_{255} / L_0$$

L255: Luminance of gray level 255, L0: Luminance of gray level 0

Note (5) Definition Of Response Time (TR, TF)

**Definition of Response Time**

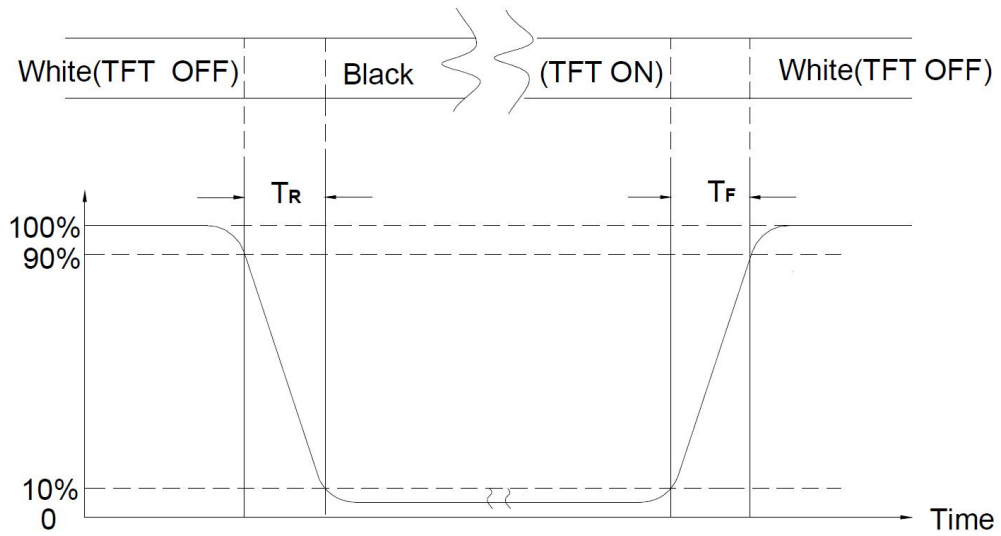

Note (6) Definition Of Brightness Luminance

$$\text{Luminance Uniformity} = \frac{(\text{Min Luminance of 9 points})}{(\text{Max Luminance of 9 points})} \times 100\%$$

**Measurement Locations**

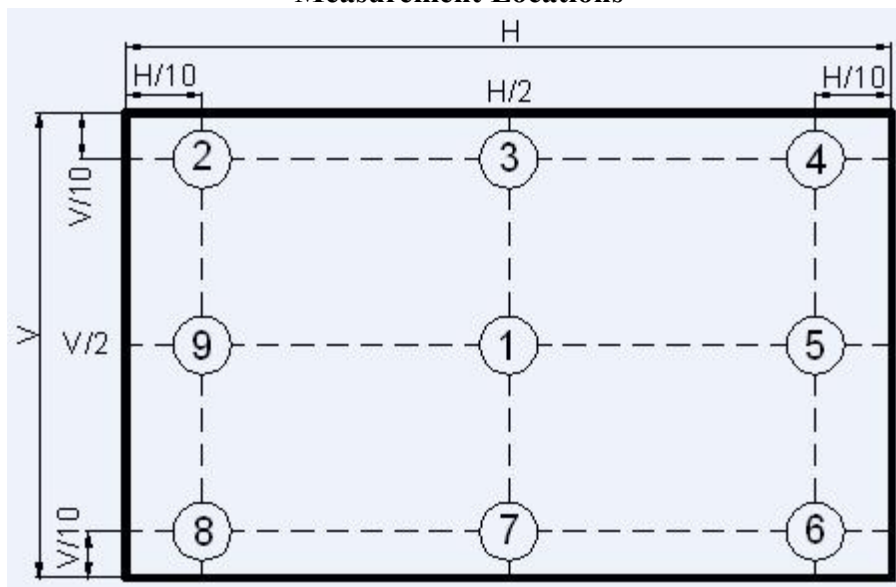

## 10 Package Specification

TBD



## 11 Reliability

Items	Required Condition	Note
High Temperature Operation Test	70°C, 300hrs	-
High Temperature Storage Test	80°C, 300hrs	-
Low Temperature Operating Test	-20°C, 300hrs	-
Low Temperature Storage Test	-30°C, 300hrs	-
High Temp./High Humidity Operating Test	50°C, 85%, 300hrs	-
Thermal Shock Non-operation Test	-20°C ~60°C, 1hr/each cycle, 100cycles	-
Shock	50G, 20ms, Half Sine Wave, ( $\pm X, \pm Y, \pm Z$ )	-
Vibration	1.5G, 10~200 Hz, x、y、z each axis/30min	-
ESD Test	Contact Discharge: $\pm 8KV, 150pF(330\Omega)$ ; Air Discharge: $\pm 15KV, 150pF(330\Omega)$	1

Note1: ESD class C: Performance could be recovered by reset if temporary failure happened.

**12 Illustration of Product Name**

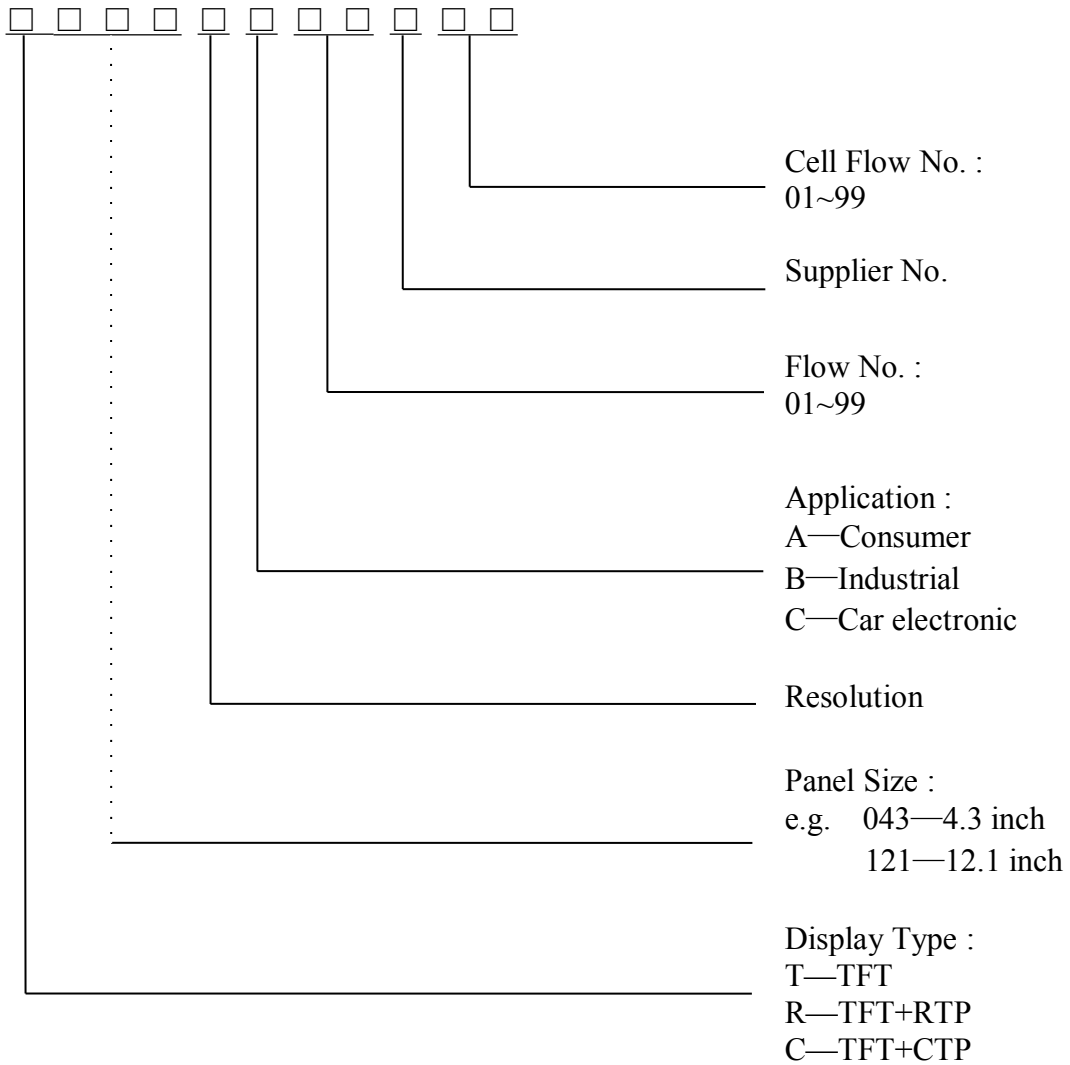

## 13 Precautions for operation and Storage

### 13.1 Precautions for Operation

- (1) Since the display panel is made of glass, do not apply any mechanical shock or impact or excessive force to it when installing the module. Any strong mechanical impact due to falling dropping etc. may cause damage (breakage or cracking).
- (2) If the display panel is damaged and the liquid crystal substance inside it leaks out, be sure not to get any in your mouth, if the substance comes into contact with your skin or clothes, promptly wash it off using soap and water.
- (3) The polarizer on the display surface is made of soft material and is easily scratched. Please take most care when handing. When the display surface is contaminated, please wipe it off gently by using moisten soft cloth with isopropyl alcohol, do not use water, ketone or aromatics. If still not completely clear, moisten cloth with isopropyl alcohol or ethyl alcohol solvents.
- (4) When handling the LCD module, please be sure that the body and the tools are properly grounded. And do not touch I/O pins with bare hands or contaminate I/O pins, it will cause disconnection or defective insulation of terminals.
- (5) Do not attempt to disassemble or process the LCD module.
- (6) The LCD Module is coated with a film to protect the display surface. Be care when peeling off this protective film since static electricity may be generated. To reduce the amount of static electricity generated, do not conduct assembly and other work under dry conditions.
- (7) Do not put one product on the other .Otherwise, it may cause the product to bescratched and/or change on cosmetic occur (ex. Newton ring).

### 13.2 Soldering

- (1) Soldering should be performed only on the I/O terminals.
- (2) Use soldering irons with proper grounding and no leakage.
- (3) Iron: no higher than 300°C and 3~4 sec during soldering.

### 13.3 Precautions for Storage

- (1) Please store LCD module in a dark place. Avoid exposure to sunlight, the light of fluorescent lamp or any ultraviolet ray.
- (2) Keep the environment temperature between 0°C and 40°C and the relative humidity less than 80%.Avoid high temperature and high humidity.
- (3) Keep the LCD modules stored in the room without acid ,alkali and harmful gas.

### 13.4 Warranty period

Visionox warrants for a period of 12 months from the shipping date when stored or used under normal condition.