

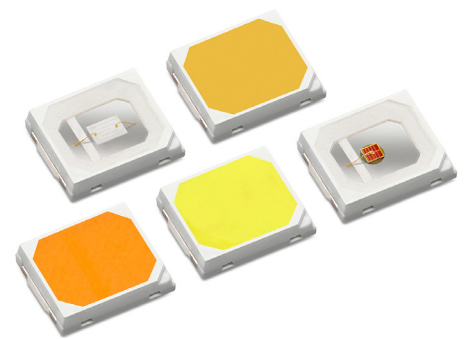

# LUXEON 2835 Color Line

The best performance, the most colors.

The LUXEON 2835 Color Line enables a new era of color lighting. This robust color line provides high performance and is targeted at cost effective designs. Complemented by a broad range of white offerings, the LUXEON 2835 Color Line enables RGBW applications. This product line extends the comprehensive LUXEON Color Family.



## FEATURES AND BENEFITS

Single die and single source architecture for optical control

Full color palette for a wider spectrum range

## PRIMARY APPLICATIONS

Architectural & Entertainment

Lamps

– Color Tunable Illumination

Specialty Lighting

– Emergency Vehicle

– Signage

# Table of Contents

<b>General Product Information</b> .....	<b>2</b>
Product Test Conditions .....	2
Part Number Nomenclature .....	2
Lumen Maintenance .....	2
Environmental Compliance .....	2
<b>Performance Characteristics</b> .....	<b>3</b>
Product Selection Guide .....	3
Optical Characteristics .....	4
Electrical and Thermal Characteristics .....	5
<b>Absolute Maximum Ratings</b> .....	<b>5</b>
<b>Characteristic Curves</b> .....	<b>6</b>
Spectral Power Distribution Characteristics .....	6
Light Output Characteristics .....	7
Forward Current Characteristics .....	11
Radiation Pattern Characteristics .....	13
<b>Product Bin and Labeling Definitions</b> .....	<b>14</b>
Decoding Product Bin Labeling .....	14
Luminous Flux Bins .....	15
Radiometric Power Bins .....	15
Color Bin Definitions .....	16
Peak Wavelength Bins .....	19
Dominant Wavelength Bins .....	19
Forward Voltage Bins .....	20
<b>Mechanical Dimensions</b> .....	<b>20</b>
<b>Reflow Soldering Guidelines</b> .....	<b>21</b>
JEDEC Moisture Sensitivity .....	21
Solder Pad Design .....	22
<b>Packaging Information</b> .....	<b>22</b>
Pocket Tape Dimensions .....	22
Reel Dimensions .....	23

# General Product Information

## Product Test Conditions

LUXEON 2835 Color Line LEDs are tested and binned with a 20ms monopulse of 120mA at a junction temperature,  $T_j$ , of 25°C.

## Part Number Nomenclature

Part numbers for LUXEON 2835 Color Line follow the convention below:

L 1 2 8 – **A A A** 1 0 0 3 5 0 0 0 0 0

Where:

**A A A** – designates color (FRD=Far Red, DRD=Deep Red, RED=Red, RNG=Red Orange, PCA=PC Amber, MNT=Mint, LME=Lime, GRN=Green, CYN=Cyan, BLU=Blue, RYL=Royal Blue)

Therefore, the following part number is used for a LUXEON 2835 Red LED:

L 1 2 8 – **R E D** 1 0 0 3 5 0 0 0 0 0

Part numbers for LUXEON 2835 White follow the convention below:

L 1 2 8 – **A A B B** 0 0 3 5 0 0 0 0 0 0

Where:

**A A** – designates nominal CCT (30=3000K, 40=4000K, 57=5700K)

**B B** – designates minimum CRI (70=70CRI, 80=80CRI)

Therefore, the following part number is used for LUXEON 2835 White at 3000K 80CRI LED:

L 1 2 8 – **3 0 8 0** 0 0 3 5 0 0 0 0 0 0

## Lumen Maintenance

Please contact your local Sales Representative or Lumileds Technical Solutions Manager for more information about the long-term performance of this product.

## Environmental Compliance

Lumileds LLC is committed to providing environmentally friendly products to the solid-state lighting market. LUXEON 2835 Color Line is compliant to the European Union directives on the restriction of hazardous substances in electronic equipment, namely the RoHS Directive 2011/65/EU and REACH Regulation (EC) 1907/2006. Lumileds LLC will not intentionally add the following restricted materials to its products: lead, mercury, cadmium, hexavalent chromium, polybrominated biphenyls (PBB) or polybrominated diphenyl ethers (PBDE).

# Performance Characteristics

## Product Selection Guide

Table 1a. Product performance of LUXEON 2835 Colors at 120mA and 200mA,  $T_j=25^\circ\text{C}$ .

COLOR	DOMINANT or PEAK WAVELENGTH <sup>[1]</sup> (nm)		LUMINOUS FLUX <sup>[2]</sup> (lm) or RADIOMETRIC POWER <sup>[3]</sup> (mW)			PART NUMBER
	MINIMUM	MAXIMUM	MINIMUM	120mA TYPICAL	200mA TYPICAL	
Far Red	720	740	85	97	159	L128-FRD1003500000
Deep Red	650	670	98	108	192	L128-DRD1003500000
Red	620	630	15	17	27	L128-RED1003500000
Red-Orange	610	620	19	20	32	L128-RNG1003500000
PC Amber	-	-	44	48	75	L128-PCA1003500000
Mint	-	-	69	75	117	L128-MNT1003500000
Lime	-	-	70	77	121	L128-LME1003500000
Green	520	540	40	47	61	L128-GRN1003500000
Cyan	490	510	21	27	38	L128-CYN1003500000
Blue	469	480	13	16	24	L128-BLU1003500000
Royal Blue	440	455	185	205	325	L128-RYL1003500000

**Notes for Table 1a:**

- Lumileds maintains a tolerance of  $\pm 1\text{nm}$  on dominant wavelength measurements. PC Amber, Mint and Lime are binned by chromaticity coordinates. Far Red, Deep Red and Royal Blue are binned by peak wavelength. All other colors are binned by dominant wavelength.
- Lumileds maintains a tolerance of  $\pm 7.5\%$  on luminous flux measurements.
- Far Red, Deep Red and Royal Blue are binned by radiometric power. All other colors are binned by luminous flux.

Table 1b. Product performance of LUXEON 2835 White at 120mA,  $T_j=25^\circ\text{C}$ .

COLOR	NOMINAL CCT	MINIMUM CRI <sup>[1]</sup>	LUMINOUS FLUX <sup>[1]</sup> (lm)		TYPICAL LUMINOUS EFFICACY (lm/W)	PART NUMBER
			MINIMUM	TYPICAL		
White	5700K	70	58	64	187	L128-5770003500000
	3000K	80	54	59	173	L128-3080003500000
	4000K	80	56	62	181	L128-4080003500000

**Notes for Table 1b:**

- Lumileds maintains a tolerance of  $\pm 7.5\%$  on luminous flux measurements.

# Optical Characteristics

Table 2a. Optical characteristics for LUXEON 2835 Colors at test current, 120mA, T<sub>j</sub>=25°C.

COLOR	PART NUMBER	TYPICAL SPECTRAL HALF-WIDTH <sup>[1]</sup> (nm)	TYPICAL TEMPERATURE COEFFICIENT OF WAVELENGTH (nm/°C)	TYPICAL TOTAL INCLUDED ANGLE <sup>[2]</sup>	TYPICAL VIEWING ANGLE <sup>[3]</sup>
Far Red	L128-FRD1003500000	30	0.17	140°	130°
Deep Red	L128-DRD1003500000	20	0.16	140°	130°
Red	L128-RED1003500000	15	0.05	140°	130°
Red-Orange	L128-RNG1003500000	15	0.07	140°	130°
PC Amber	L128-PCA1003500000	95	0.01	140°	120°
Mint	L128-MNT1003500000	110	0.01	140°	120°
Lime	L128-LME1003500000	110	0.01	140°	120°
Green	L128-GRN1003500000	28	0.05	140°	130°
Cyan	L128-CYN1003500000	25	0.03	140°	130°
Blue	L128-BLU1003500000	20	0.03	140°	130°
Royal Blue	L128-RYL1003500000	15	0.04	140°	130°

**Notes for Table 2a:**

1. Spectral half-width is the spectral bandwidth at 50% of the peak intensity.
2. Total angle at which 90% of total luminous flux is captured.
3. Viewing angle is the off axis angle from the LED centerline where the luminous intensity is ½ of the peak value.

Table 2b. Optical characteristics for LUXEON 2835 White at 120mA, T<sub>j</sub>=25°C.

COLOR	PART NUMBER	TYPICAL TOTAL INCLUDED ANGLE <sup>[1]</sup>	TYPICAL VIEWING ANGLE <sup>[1]</sup>
White	L128-xxx003500000	160°	120°

**Notes for Table 2b:**

1. Total angle at which 90% of total luminous flux is captured.
2. Viewing angle is the off axis angle from the LED centerline where the luminous intensity is ½ of the peak value.

# Electrical and Thermal Characteristics

Table 3. Electrical and thermal characteristics for LUXEON 2835 Color Line at 120mA, T<sub>j</sub>=25°C.

COLOR	PART NUMBER	FORWARD VOLTAGE <sup>[1]</sup> (V <sub>f</sub> )			TYPICAL TEMPERATURE COEFFICIENT OF FORWARD VOLTAGE <sup>[2]</sup> (mV/°C)	TYPICAL THERMAL RESISTANCE — JUNCTION TO SOLDER PAD (°C/W)
		MINIMUM	TYPICAL	MAXIMUM		
Far Red	L128-FRD1003500000	1.80	2.15	2.50	-2.0	15
Deep Red	L128-DRD1003500000	1.80	2.15	2.50	-2.0	15
Red	L128-RED1003500000	1.80	2.10	2.50	-2.0	15
Red-Orange	L128-RNG1003500000	1.80	2.10	2.50	-1.7	15
PC Amber	L128-PCA1003500000	2.80	3.00	3.10	-1.7	25
Mint	L128-MNT1003500000	2.80	3.00	3.10	-2.5	25
Lime	L128-LME1003500000	2.80	3.00	3.10	-1.7	25
Green	L128-GRN1003500000	2.80	3.15	3.30	-3.0	69
Cyan	L128-CYN1003500000	2.90	3.10	3.30	-2.5	50
Blue	L128-BLU1003500000	2.80	3.00	3.20	-2.5	25
Royal Blue	L128-RYL1003500000	2.80	3.00	3.20	-2.5	25
White	L128-xxx003500000	2.70	2.85	3.00	-1.0 to -2.0	13

**Notes for Table 3:**

1. Lumileds maintains a tolerance of ±0.1V on forward voltage measurements.
2. Measured between 25°C and 85°C.

# Absolute Maximum Ratings

Table 4. Absolute maximum ratings for LUXEON 2835 Color Line.

PARAMETER	FAR RED	DEEP RED, RED, and RED-ORANGE	PC AMBER, MINT, LIME, GREEN, CYAN, BLUE and ROYAL BLUE	WHITE
DC Forward Current <sup>[1, 2]</sup>	300mA	250mA	240mA	480mA
Peak Pulsed Forward Current <sup>[1, 3]</sup>	350mA	300mA	300mA	500mA
LED Junction Temperature <sup>[1]</sup> (DC & Pulse)	125°C	125°C	125°C	125°C
ESD Sensitivity (ANSI/ESDA/JEDEC JS-001-2012)	Class 2	Class 2	Class 2	Class 2
Operating Case Temperature <sup>[1]</sup>	105°C	105°C	105°C	105°C
LED Storage Temperature	-40°C to 105°C	-40°C to 105°C	-40°C to 95°C	-40°C to 105°C
Soldering Temperature	JEDEC 020c 260°C			
Allowable Reflow Cycles	3			
Reverse Voltage (V <sub>reverse</sub> )	LUXEON LEDs are not designed to be driven in reverse bias			

**Notes for Table 4:**

1. Proper current derating must be observed to maintain the junction temperature below the maximum allowable junction temperature.
2. Residual periodic variations due to power conversion from alternating current (AC) to direct current (DC), also called "ripple," are acceptable if the following conditions are met:
  - The frequency of the ripple current is 100Hz or higher
  - The average current for each cycle does not exceed the maximum allowable DC forward current
  - The maximum amplitude of the ripple does not exceed the maximum peak pulsed forward current
3. At 10% duty cycle with pulse width of 10ms.

# Characteristic Curves

## Spectral Power Distribution Characteristics



Figure 1a. Typical normalized power vs. wavelength for LUXEON 2835 Colors at 120mA,  $T_j=25^{\circ}\text{C}$ .



Figure 1b. Typical normalized power vs. wavelength for LUXEON 2835 White at 120mA,  $T_j=25^{\circ}\text{C}$ .

# Light Output Characteristics



Figure 2a. Typical normalized light output vs. junction temperature for LUXEON 2835 Mint, Lime, Green, Cyan, and Blue at 120mA.



Figure 2b. Typical normalized light output vs. junction temperature for LUXEON 2835 Red, Red-Orange, and PC Amber at 120mA.





Figure 2c. Typical normalized radiant power vs. junction temperature for LUXEON 2835 Far Red, Deep Red, and Royal Blue at 120mA.



Figure 2d. Typical normalized light output vs. junction temperature for LUXEON 2835 White at 120mA.



Figure 3a. Typical normalized light output vs. forward current for LUXEON 2835 Mint, Lime, Green, Cyan, and Blue at  $T_j=25^\circ\text{C}$ .



Figure 3b. Typical normalized light output vs. forward current for LUXEON 2835 Red, Red-Orange, and PC Amber at  $T_j=25^\circ\text{C}$ .



Figure 3c. Typical normalized radiant power vs. forward current for LUXEON 2835 Far Red, Deep Red, and Royal Blue at  $T_j=25^\circ\text{C}$ .



Figure 3d. Typical normalized light output vs. forward current for LUXEON 2835 White at  $T_j=25^\circ\text{C}$ .

# Forward Current Characteristics



Figure 4a. Typical forward current vs. forward voltage for LUXEON 2835 Mint, Lime, Green, Cyan, and Blue at  $T_j=25^\circ\text{C}$ .



Figure 4b. Typical forward current vs. forward voltage for LUXEON 2835 Red, Red-Orange, and PC Amber at  $T_j=25^\circ\text{C}$ .



Figure 4c. Typical forward current vs. forward voltage for LUXEON 2835 Far Red, Deep Red, and Royal Blue at  $T_j=25^\circ\text{C}$ .



Figure 4d. Typical forward current vs. forward voltage for LUXEON 2835 White at  $T_j=25^\circ\text{C}$ .

## Radiation Pattern Characteristics

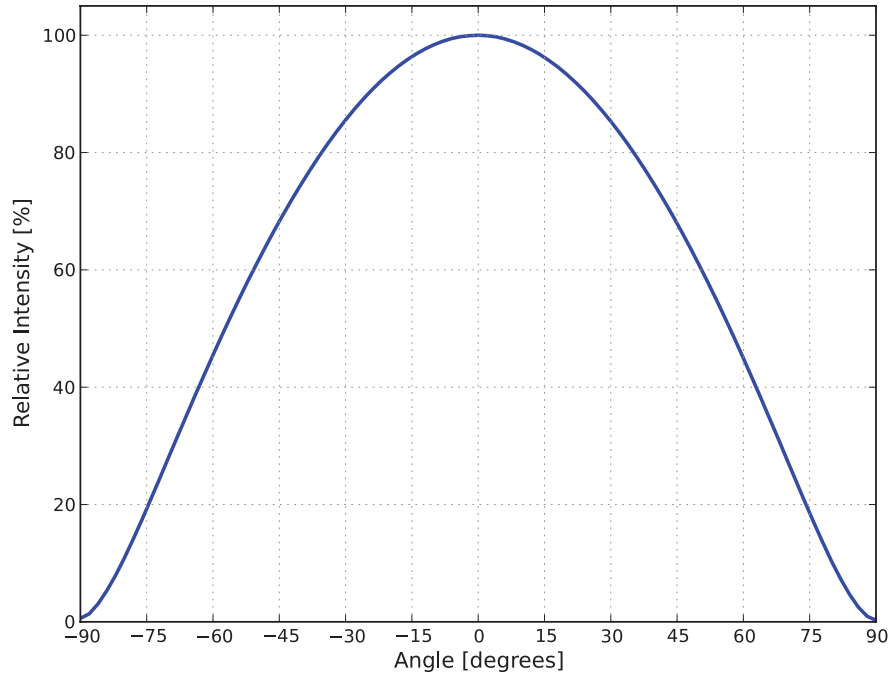

Figure 5. Typical radiation pattern for LUXEON 2835 Color Line at 120mA,  $T_j=25^{\circ}\text{C}$ .

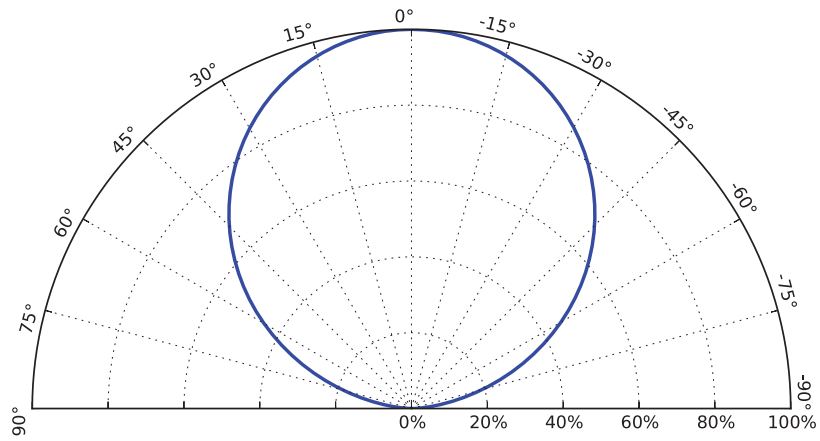

Figure 6. Typical polar radiation pattern for LUXEON 2835 Color Line at 120mA,  $T_j=25^{\circ}\text{C}$ .

# Product Bin and Labeling Definitions

## Decoding Product Bin Labeling

In the manufacturing of semiconductor products, there are variations in performance around the average values given in the technical datasheet. For this reason, Lumileds bins LED components for luminous flux or radiometric power, color point, peak or dominant wavelength and forward voltage.

LUXEON 2835 Color Line LEDs are labeled using a 4-digit alphanumeric CAT code following the format below:

### **A B C D**

Where:

- A** – designates luminous flux bin or radiometric power bin (luminous flux bin example: L=32.0 to 36.0 lm, R=52.0 to 56.0 lm; radiometric power bin example: D=100 to 110mW)
- B C** – designates color bin, peak wavelength bin or dominant wavelength bin (color bin examples: Lime=20, White 3000K example=7D, 7E, 7F, etc.; peak wavelength bin example: Deep Red 10=650 to 670nm; dominant wavelength bin example: Red 40=620 to 630nm)
- D** – designates forward voltage bin (example: A=2.80 to 2.90V, C=3.00 to 3.10V)

Therefore, a Lime LUXEON 2835 LED with a lumen range of 32.0 to 36.0 lm, color bin of 20 and a forward voltage range of 3.00 to 3.10V has the following CAT code:

### **L 2 0 C**

## Luminous Flux Bins

Table 5 lists the standard luminous flux bins for LUXEON 2835 Color Line emitters. Although several bins are outlined, product availability in a particular bin varies by production run and by product performance. Not all bins are available in all CCTs.

**Table 5. Luminous flux bin definitions for LUXEON 2835 Color Line, at  $T_j=25^\circ\text{C}$ .**

BIN	LUMINOUS FLUX <sup>[1]</sup> (lm)	
	MINIMUM	MAXIMUM
D	13	15
E	15	17
F	17	19
G	19	21
H	21	24
J	24	28
K	28	32
L	32	36
M	36	40
N	40	44
P	44	48
Q	48	52
R	52	56
S	56	60
T	60	65
U	65	70
V	70	75
W	75	80
X	80	85
Y	85	90

**Notes for Table 5:**

1. Lumileds maintains a tolerance of  $\pm 7.5\%$  on luminous flux measurements.

## Radiometric Power Bins

**Table 6. Radiometric power bin definitions for LUXEON 2835 Far Red, Deep Red and Royal Blue.**

BIN	RADIOMETRIC POWER <sup>[1]</sup> (mW)	
	MINIMUM	MAXIMUM
A	70	80
B	80	90
C	90	100
D	100	110
E	110	120
F	120	130
G	130	150
H	150	170
J	170	190
K	190	210
L	210	230
M	230	250

**Notes for Table 6:**

1. Lumileds maintains a tolerance of  $\pm 6.5\%$  on radiometric power measurements.



# Color Bin Definitions



Figure 7. Color Bin Structure for LUXEON 2835 PC Amber for Table 7.

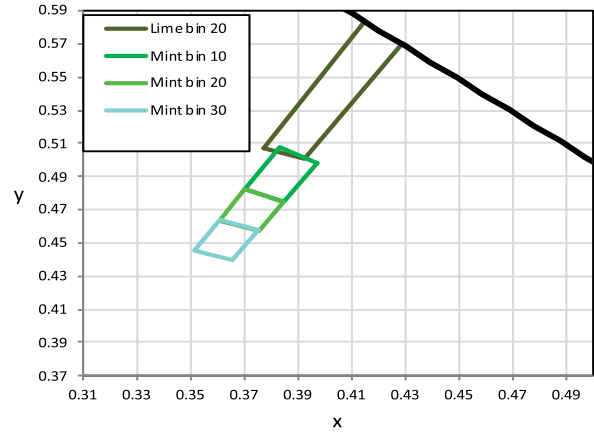

Figure 8. Color Bin Structure for LUXEON 2835 Lime and Mint for Table 7.

Table 7. Color bin definitions for LUXEON 2835 PC Amber and Lime.

COLOR	PART NUMBER	BIN	x	y	
PC Amber	L128-PCA1003500000	10	0.5622	0.4372	
			0.5843	0.4152	
			0.5705	0.4111	
			0.5499	0.4249	
Mint	L128-MNT1003500000	10	0.3927	0.4986	
			0.3830	0.5077	
			0.3703	0.4825	
		20	0.3846	0.4749	
			0.3846	0.4749	
			0.3703	0.4825	
			0.3608	0.4639	
			0.3752	0.4572	
			0.3752	0.4572	
			0.3608	0.4639	
30	0.3515	0.4453			
	0.3659	0.4396			
	Lime	L128-LME1003500000	20	0.3773	0.5076
				0.3927	0.5007
0.4287				0.5697	
0.4150				0.5833	

**Notes for Table 7:**

1. Lumileds maintains a tolerance of  $\pm 0.01$  on x and y coordinates in the CIE 1931 color space.

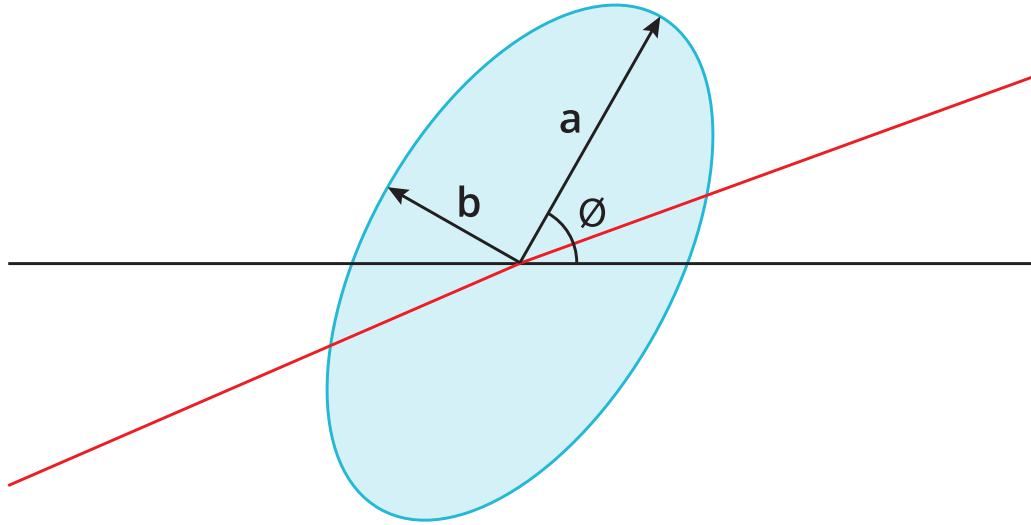

Figure 9. 3- and 5-step MacAdam ellipse illustration for Tables 8a–8c.



Figure 10a. 1/9<sup>th</sup> color bin structure for LUXEON 2835 White 3000K at test current and binning temperature of  $T_j=25^{\circ}\text{C}$ .

Table 8a. 3- and 5-step MacAdam ellipse color bin definitions for LUXEON 2835E and LUXEON 2835C 3000K, at test and binning conditions.

NOMINAL CCT	COLOR SPACE	CENTER POINT <sup>[1]</sup> (cx, cy)	MAJOR AXIS, a	MINOR AXIS, b	ELLIPSE ROTATION ANGLE, Θ
3000K	Single 3-step MacAdam ellipse	(0.4338, 0.4030)	0.00834	0.00408	53.22°
3000K	Single 5-step MacAdam ellipse	(0.4338, 0.4030)	0.01390	0.00680	53.22°

Notes for Table 8a:

1. Lumileds maintains a tolerance of  $\pm 0.007$  on x and y color coordinates in the CIE 1931 color space.



Figure 10b. 1/9<sup>th</sup> color bin structure for LUXEON 2835E and LUXEON 2835C 4000K at test current and binning temperature of  $T_j=25^\circ\text{C}$ .

Table 8b. 3- and 5-step MacAdam ellipse color bin definitions for LUXEON 2835E and LUXEON 2835C 4000K, at test and binning conditions.

NOMINAL CCT	COLOR SPACE	CENTER POINT <sup>[1]</sup> (cx, cy)	MAJOR AXIS, a	MINOR AXIS, b	ELLIPSE ROTATION ANGLE, $\theta$
4000K	Single 3-step MacAdam ellipse	(0.3818, 0.3797)	0.00939	0.00402	53.72°
4000K	Single 5-step MacAdam ellipse	(0.3818, 0.3797)	0.01565	0.00670	53.72°

Notes for Table 8b:

1. Lumileds maintains a tolerance of  $\pm 0.007$  on x and y color coordinates in the CIE 1931 color space.

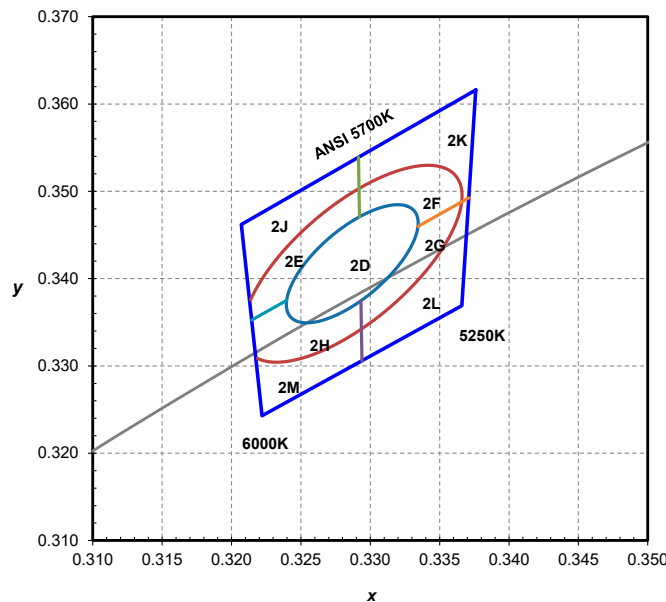

Figure 10c. 1/9<sup>th</sup> color bin structure for LUXEON 2835E and LUXEON 2835C 5700K at test current and binning temperature of  $T_j=25^\circ\text{C}$ .

Table 8c. 3- and 5-step MacAdam ellipse color bin definitions for LUXEON 2835E and LUXEON 2835C 5700K, at test and binning conditions.

NOMINAL CCT	COLOR SPACE	CENTER POINT <sup>[1]</sup> (cx, cy)	MAJOR AXIS, a	MINOR AXIS, b	ELLIPSE ROTATION ANGLE, $\theta$
5700K	Single 3-step MacAdam ellipse	(0.3287, 0.3417)	0.00746	0.00320	59.09°
5700K	Single 5-step MacAdam ellipse	(0.3287, 0.3417)	0.01243	0.00533	59.09°

Notes for Table 8c:

1. Lumileds maintains a tolerance of  $\pm 0.007$  on x and y color coordinates in the CIE 1931 color space.

## Peak Wavelength Bins

Table 9. Peak wavelength bin definitions for LUXEON 2835 Far Red, Deep Red and Royal Blue.

COLOR	PART NUMBER	BIN	PEAK WAVELENGTH <sup>[1]</sup> (nm)	
			MINIMUM	MAXIMUM
Far Red	L128-FRD1003500000	10	720	740
Deep Red	L128-DRD1003500000	10	650	670
Royal Blue	L128-RYL1003500000	30	440	445
		40	445	450
		50	450	455

Notes for Table 9:

1. Lumileds maintains a tolerance of  $\pm 0.5$ nm on peak wavelength measurements.

## Dominant Wavelength Bins

Table 10. Dominant wavelength bin definitions for LUXEON 2835 Red, Red-Orange, Green, Cyan and Blue.

COLOR	PART NUMBER	BIN	DOMINANT WAVELENGTH <sup>[1]</sup> (nm)	
			MINIMUM	MAXIMUM
Red	L128-RED1003500000	40	620	630
Red-Orange	L128-RNG1003500000	20	610	620
Green	L128-GRN1003500000	10	520	525
		20	525	530
		30	530	535
		40	535	540
Cyan	L128-CYN1003500000	10	490	495
		20	495	500
		30	500	505
		40	505	510
Blue	L128-BLU1003500000	20	469	475
		30	475	480

Notes for Table 10:

1. Lumileds maintains a tolerance of  $\pm 1$ nm on dominant wavelength measurements.

# Forward Voltage Bins

Table 11a. Forward voltage bin definitions for LUXEON 2835 Far Red, Deep Red, Red and Red-Orange.

BIN	FORWARD VOLTAGE <sup>(1)</sup> (V <sub>f</sub> )	
	MINIMUM	MAXIMUM
B	1.80	2.00
C	2.00	2.20
D	2.20	2.40
E	2.40	2.60

Table 11b. Forward voltage bin definitions for LUXEON 2835 PC Amber, Mint, Lime, Green, Cyan, Blue, Royal Blue and White.

BIN	FORWARD VOLTAGE <sup>(1)</sup> (V <sub>f</sub> )	
	MINIMUM	MAXIMUM
Z	2.70	2.80
A	2.80	2.90
B	2.90	3.00
C	3.00	3.10
D	3.10	3.20
E	3.20	3.30

Notes for Tables 11a and 11b:

1. Lumileds maintains a tolerance of  $\pm 0.1V$  on forward voltage measurements.

# Mechanical Dimensions

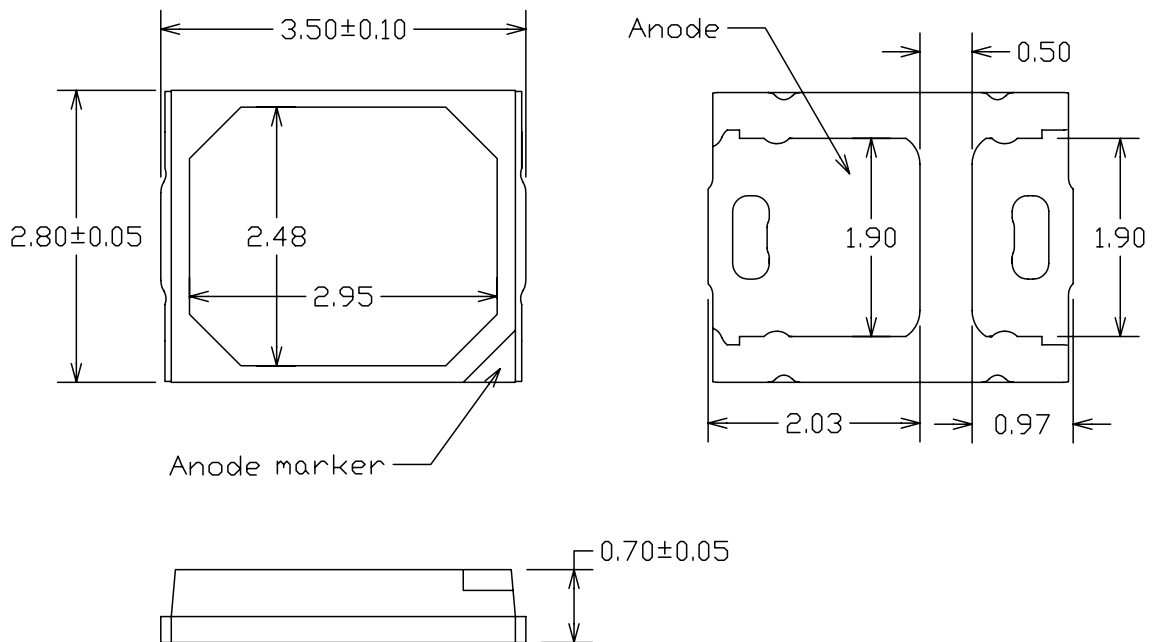

Figure 11. Mechanical dimensions for LUXEON 2835 Color Line.

Notes for Figure 11:

1. Drawings are not to scale.
2. All dimensions are in millimeters.
3. Tolerance of  $\pm 0.1mm$ .

# Reflow Soldering Guidelines



Figure 12. Visualization of the acceptable reflow temperature profile as specified in Table 12.

Table 12. Reflow profile characteristics for LUXEON 2835 Color Line.

PROFILE FEATURE	LEAD-FREE ASSEMBLY
Preheat Minimum Temperature ( $T_{s_{min}}$ )	150°C
Preheat Maximum Temperature ( $T_{s_{max}}$ )	200°C
Preheat Time ( $t_{s_{min}}$ to $t_{s_{max}}$ )	60 to 120 seconds
Ramp-Up Rate ( $T_L$ to $T_p$ )	3°C / second maximum
Liquidus Temperature ( $T_L$ )	217°C
Time Maintained Above Temperature $T_L$ ( $t_t$ )	10 to 30 seconds
Peak / Classification Temperature ( $T_p$ )	260°C
Time Within 5°C of Actual Temperature ( $t_p$ )	30 seconds
Ramp-Down Rate ( $T_p$ to $T_L$ )	6°C / second maximum
Time 25°C to Peak Temperature	8 minutes maximum

## JEDEC Moisture Sensitivity

Table 13. Moisture sensitivity levels for LUXEON 2835 Color Line.

LEVEL	FLOOR LIFE		SOAK REQUIREMENTS STANDARD	
	TIME	CONDITIONS	TIME	CONDITIONS
3	168 Hours	≤30°C / 60% RH	192 Hours +5 / -0	30°C / 60% RH

# Solder Pad Design

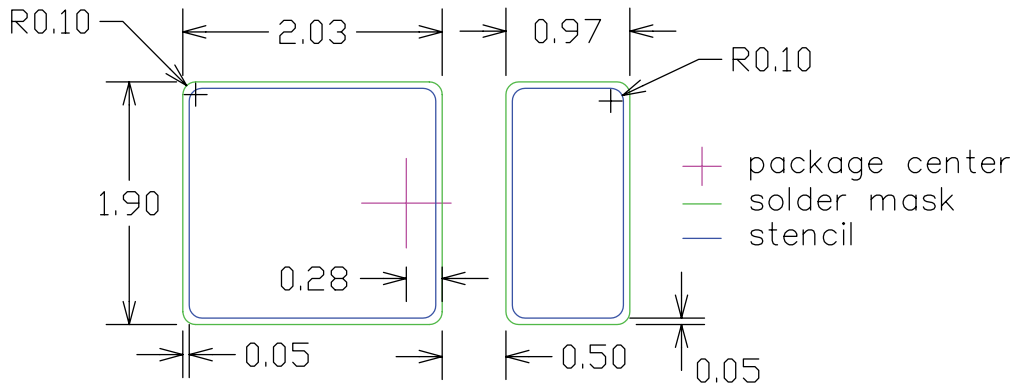

Figure 13. Recommended PCB solder pad layout for LUXEON 2835 Color Line.

**Notes for Figure 13:**

1. Drawings are not to scale.
2. All dimensions are in millimeters.

# Packaging Information

## Pocket Tape Dimensions

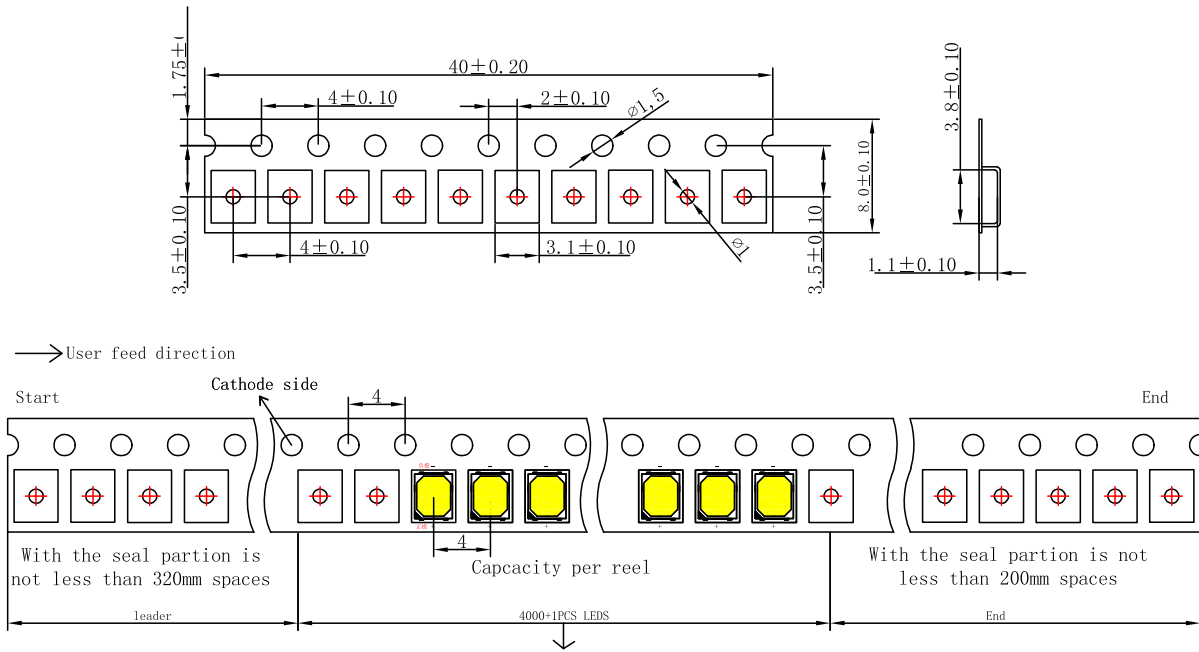

Figure 14. Pocket Tape dimensions for LUXEON 2835 Color Line.

**Notes for Figure 14:**

1. Drawings are not to scale.
2. All dimensions are in millimeters.
3. Empty components pockets sealed with top cover tape.

# Reel Dimensions



Figure 15. Reel dimensions for LUXEON 2835 Color Line.

**Notes for Figure 15:**

1. Drawings are not to scale.
2. All dimensions are in millimeters.
3. Empty component pockets sealed with top cover tape.
4. 329mm reel — 5,000 pieces per reel.
5. Minimum packing quantity is 5,000 pieces.
6. The maximum number of consecutive missing LEDs is two.
7. In accordance with EIA-481-1-B specification.



## About Lumileds

Companies developing automotive, mobile, IoT and illumination lighting applications need a partner who can collaborate with them to push the boundaries of light. With over 100 years of inventions and industry firsts, Lumileds is a global lighting solutions company that helps customers around the world deliver differentiated solutions to gain and maintain a competitive edge. As the inventor of Xenon technology, a pioneer in halogen lighting and the leader in high performance LEDs, Lumileds builds innovation, quality and reliability into its technology, products and every customer engagement. Together with its customers, Lumileds is making the world better, safer, more beautiful—with light.

To learn more about our lighting solutions, visit [lumileds.com](http://lumileds.com).



©2019 Lumileds Holding B.V. All rights reserved.  
LUXEON is a registered trademark of the Lumileds Holding B.V. in the United States and other countries.

[lumileds.com](http://lumileds.com)

Neither Lumileds Holding B.V. nor its affiliates shall be liable for any kind of loss of data or any other damages, direct, indirect or consequential, resulting from the use of the provided information and data. Although Lumileds Holding B.V. and/or its affiliates have attempted to provide the most accurate information and data, the materials and services information and data are provided "as is," and neither Lumileds Holding B.V. nor its affiliates warrants or guarantees the contents and correctness of the provided information and data. Lumileds Holding B.V. and its affiliates reserve the right to make changes without notice. You as user agree to this disclaimer and user agreement with the download or use of the provided materials, information and data. A listing of Lumileds product/patent coverage may be accessed at [lumileds.com/patents](http://lumileds.com/patents).