

5

4

3

2

1

D

C

B

A

Hood lower part

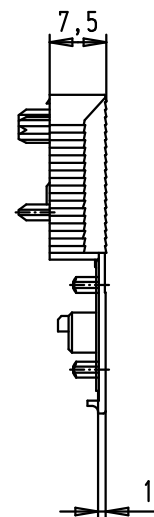
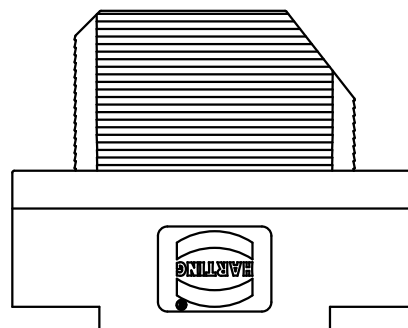
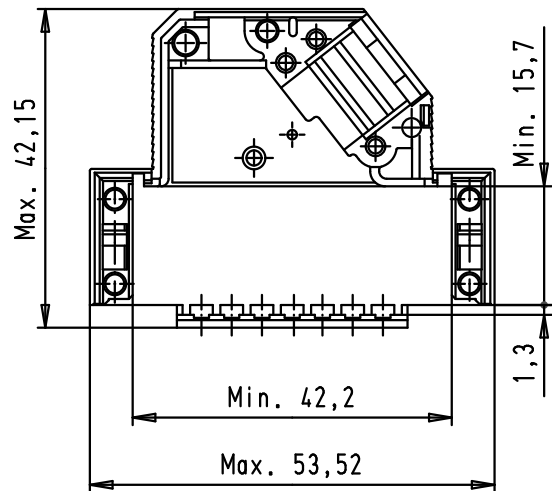
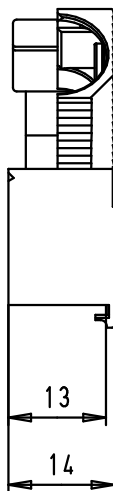
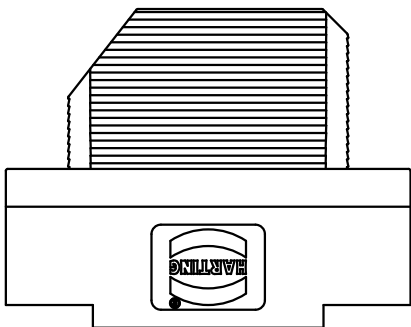

Hood upper part

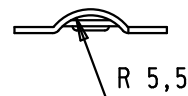
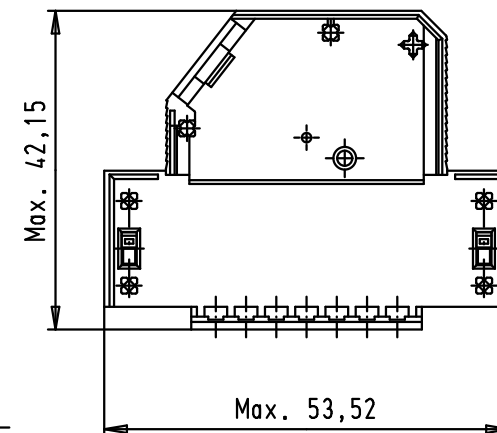

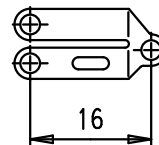

Strain relief 1

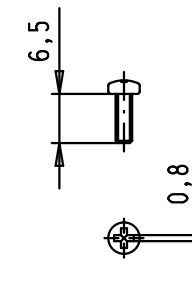
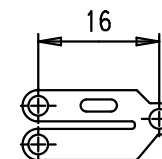

Strain relief 2



Flathead screws

| Mod.    | Dot.     | Name | Detail.                       | Dot.     | Name | <br>All Dim. in mm<br>Orig. Size DIN A 4 | D-Sub hoods<br>25 poles<br>not shielded | Maßstab/<br>Scale   |                   |             |
|---------|----------|------|-------------------------------|----------|------|---|---|---|-------------------|-------------|
| EC01696 | 20/04/10 | SC   | Insp.                         | 27/02/03 | SH   |   |   |  | TB 09 67 025 0571 | 1:1         |
| 34793   | 09/01/08 | PK   | Stand.                        |          |      |   |   |   |                   | Blatt/ Page |
| 33806   | 26/09/06 | PK   |                               |          |      |   |   |   |                   | 1 / 1       |
| 31392   | 27/02/03 | SH   |                               |          |      | Sub.  |   |   |                   |             |
|         |          |      | HARTING EURL<br>F-95972 Paris |          |      |   |   |   |                   |             |