

HC3A

High Power Resonant Capacitors



FEATURES

High AC Voltage - High current

APPLICATIONS

Induction Heating - Tank Circuits

KVAR	300
CAPACITANCE TOLERANCE	+/-10%
MAXIMUM CORE TEMPERATURE	+85°C
SURFACE TEMPERATURE	+45°C (Above 45°C the KVAR rating must be de-rated by 2.25%/°C)
CONSTRUCTION	Self-healing
SELF INDUCTANCE	< 3 nH
DIELECTRIC	Polypropylene
FLAME RETARDANT	UL94V0

Standard part listing

Capacitance (µF)	VAC	IC part number	Maximum RMS current (A)	MAX power kvar	Frequency range (kHz)	ESR (mΩ) 100kHz, +25°C	Dimensions (mm)			Terminal Style
							B	H	L	
0.10	1000	104HC3A102K2SM6	300	300	478	1.5	30.2	30	68	2SM6
0.17	1000	174HC3A102K2SM6	300	300	281	1.4	30.2	30	68	2SM6
0.33	800	334HC3A800K2SM6	400	300	225-256	1.2	30.2	30	68	2SM6
0.50	800	504HC3A800K2SM6	400	300	149-170	1.1	30.2	30	68	2SM6
0.66	700	664HC3A700K2SM6	450	300	147-163	1.0	30.2	30	68	2SM6
1.33	600	135HC3A600K2SM6	500	300	99	0.9	30.2	30	68	2SM6
2.40	500	245HC3A500K2SM6	600	300	79	0.8	30.2	30	68	2SM6



Your Global Source for World-Class Capacitors

© 2017 Illinois Capacitor

North America
Tel: 847.675.1760
sales@illcap.com

Asia
Tel: 852.2793 0931
sales@illcap.com.hk

HC3A

High Power Resonant Capacitors



TERMINAL STYLE: 2SM6

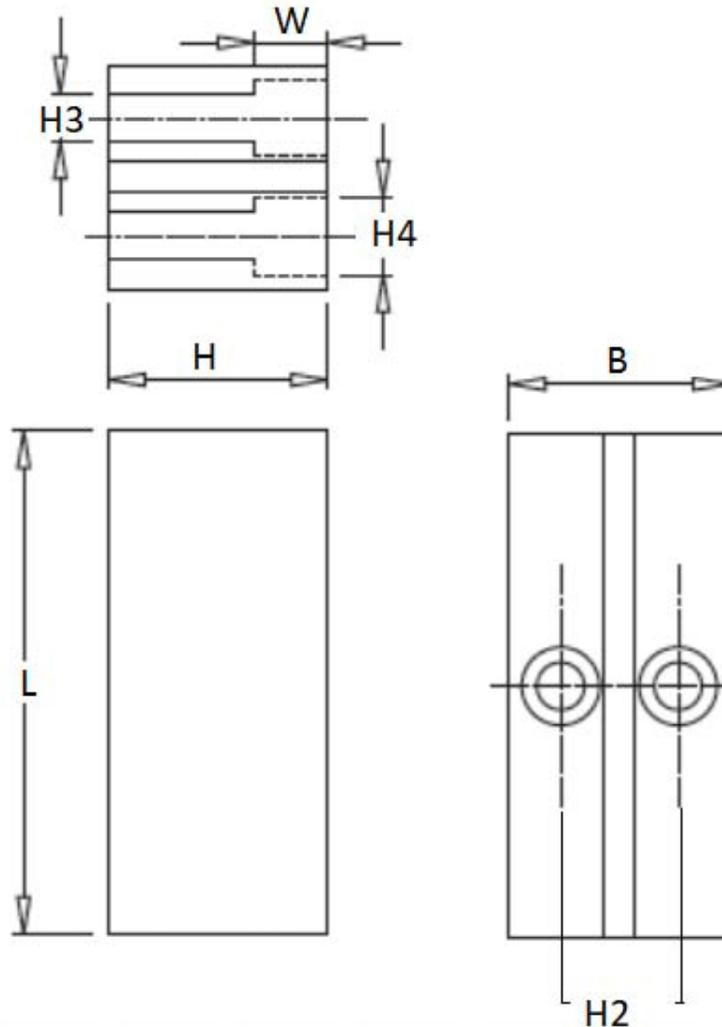

L	H	B	H2	H3	H4	W
68 \pm 0.5	30 \pm 0.5	30.2 \pm 0.1	16	6.5	10.5	10
Tightening torque: 15Nm MAX						

ILLINOIS CAPACITOR

Your Global Source for World-Class Capacitors

© 2017 Illinois Capacitor

North America
Tel: 847.675.1760
sales@illcap.com

Asia
Tel: 852.2793 0931
sales@illcap.com.hk

HC3A

High Power Resonant Capacitors



Frequency Derating

—●— Voltage —■— Current —▲— Power

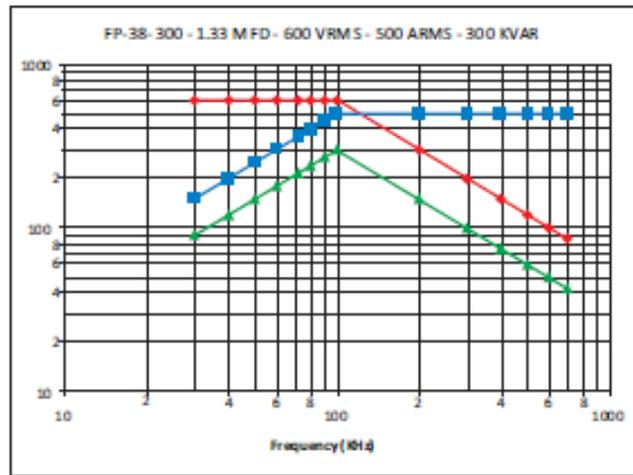
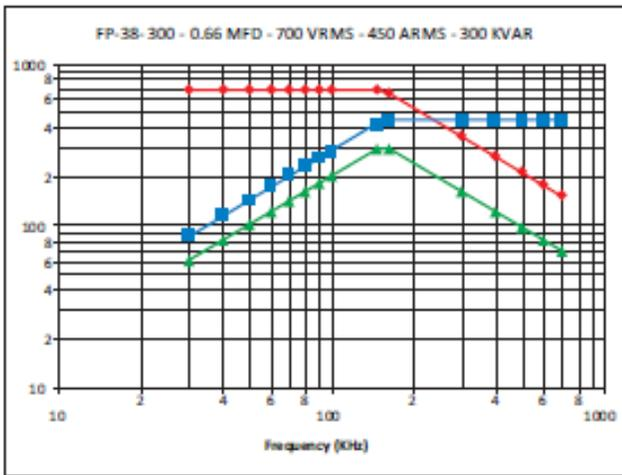
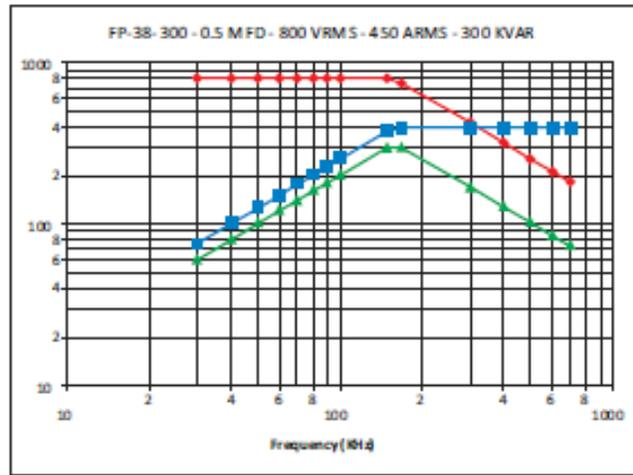
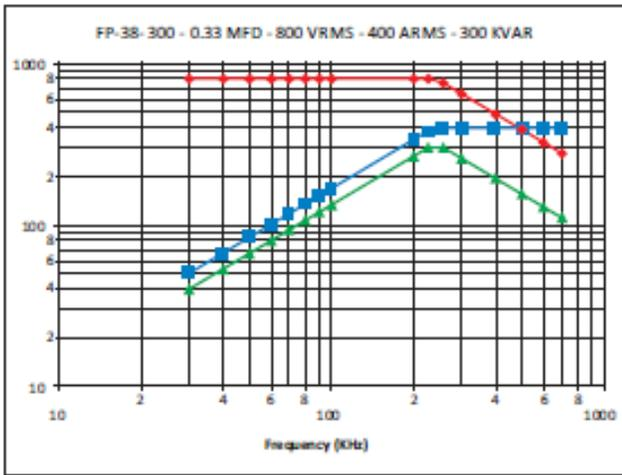
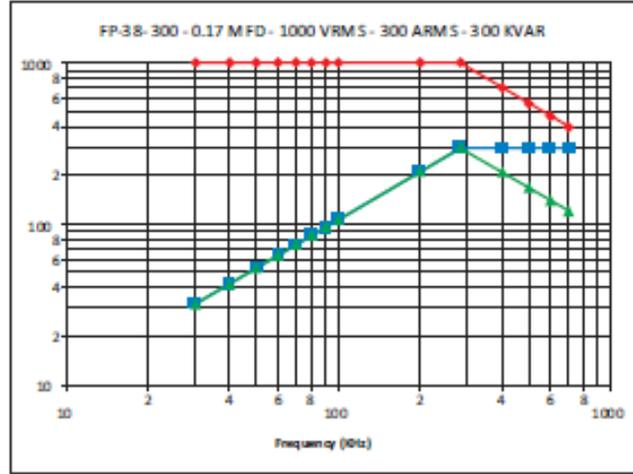
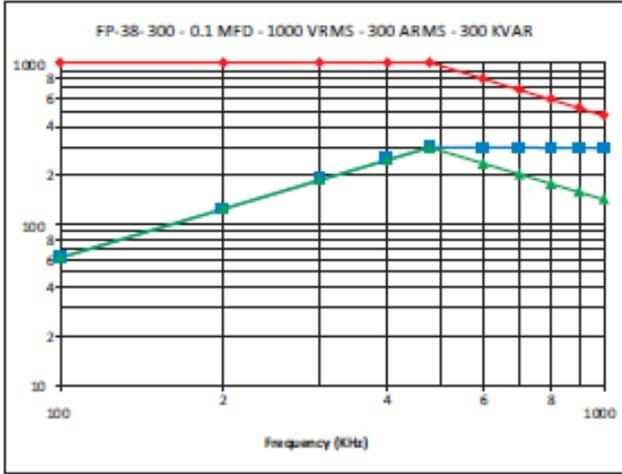

Your Global Source for World-Class Capacitors

© 2017 Illinois Capacitor

North America
Tel: 847.675.1760
sales@illcap.com

Asia
Tel: 852.2793 0931
sales@illcap.com.hk

HC3A

High Power Resonant Capacitors



Frequency Derating

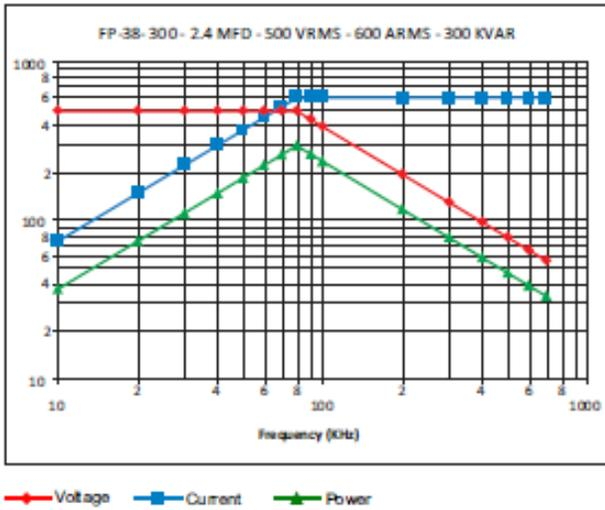

ILLINOIS CAPACITOR

Your Global Source for World-Class Capacitors

© 2017 Illinois Capacitor

North America
Tel: 847.675.1760
sales@illcap.com

Asia
Tel: 852.2793 0931
sales@illcap.com.hk