

IR eclipse click™

1. Introduction

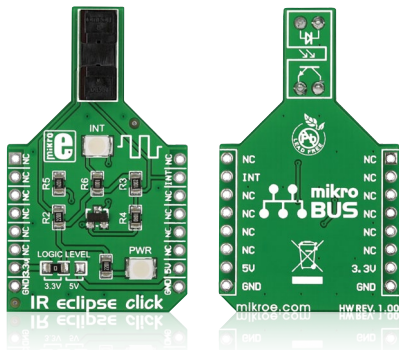

IR eclipse click™ carries an **EE-SX198** photo interrupter sensor. This sensor consists of an infrared transmitter and receiver facing each other and spaced apart by a 3mm slit. When the beam from the transmitter is eclipsed with by placing an object in the gap (like a piece of paper), the sensor is activated (indicated by the onboard INT LED). IR eclipse click™ communicates with the target board through the **mikroBUS™** INT line. It's designed to work with either a 3.3V or 5V power supply.

2. Soldering the headers

Before using your click™ board, make sure to solder 1x8 male headers to both left and right side of the board. Two 1x8 male headers are included with the board in the package.

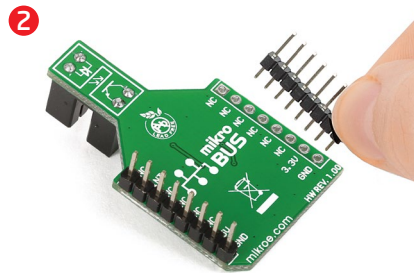
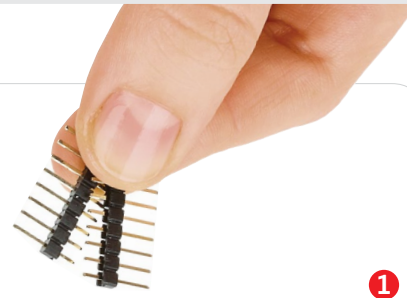

Turn the board upside down so that the bottom side is facing you upwards. Place shorter pins of the header into the appropriate soldering pads.

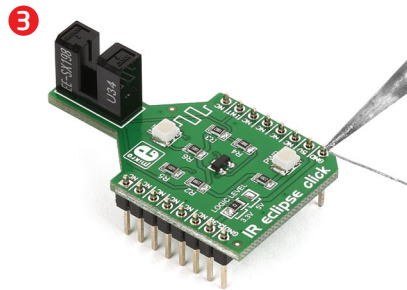

Turn the board upward again. Make sure to align the headers so that they are perpendicular to the board, then solder the pins carefully.

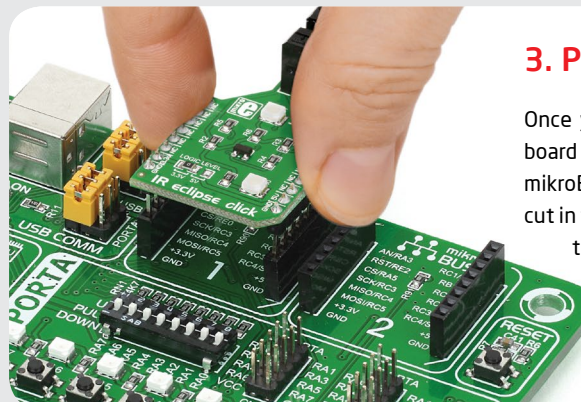

3. Plugging the board in

Once you have soldered the headers your board is ready to be placed into the desired mikroBUS™ socket. Make sure to align the cut in the lower-right part of the board with the markings on the silkscreen at the mikroBUS™ socket. If all the pins are aligned correctly, push the board all the way into the socket.

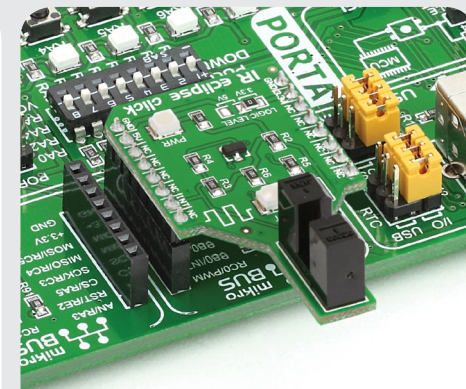

4. Essential features

Photo interrupter sensors are typically used in printers, copiers, vending machines, for optical limit switches and so on. You can implement IR eclipse in your design wherever there's a need to detect the position of a moving part, whether you need to detect if said part is in correct place, or to infer speed of rotation – as long as its thin enough to fit in the 3mm-wide slit where the infrared beam passes through.

click™
BOARD
www.mikroe.com

IR eclipse click™ manual
ver. 1.00



5. IR eclipse click™ board schematic

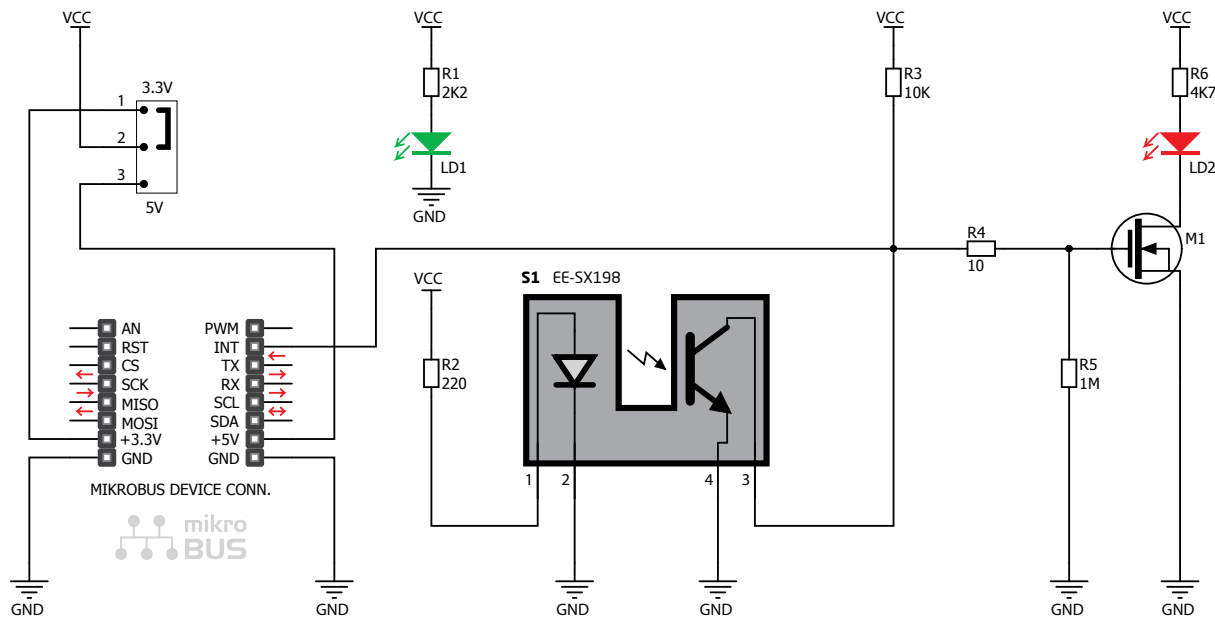

6. SMD Jumper

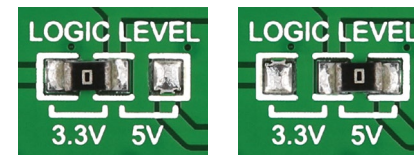

To switch between 3.3V or 5V power supplies, use the onboard zero-ohm SMD jumper. By default it's soldered in the 3.3V position.

7. Code examples

Once you have done all the necessary preparations, it's time to get your click™ board up and running. We have provided examples for mikroC™, mikroBasic™ and mikroPascal™ compilers on our **Libstock** website. Just download them and you are ready to start.



8. Support

MikroElektronika offers **free tech support** (www.mikroe.com/support) until the end of the product's lifetime, so if something goes wrong, we're ready and willing to help!