

miriac SBC-S32V

User Manual

V 1.1

Table of Contents

1	General Notes.....	4	4.15.6	Power Distribution	29
1.1	Warranty.....	4	4.15.7	MIPI Power	30
1.2	Links.....	4	4.15.8	Power Up.....	31
1.3	Liability	4	4.16	Reset Structure.....	32
1.4	Offer to Provide Source Code of Certain Software	5	5	System Core, Boot Configuration	33
1.5	Symbols, Conventions and Abbreviations	6	5.1	Processor NXP S32V234	33
1.5.1	Symbols	6	5.2	Boot Mode Configuration	34
1.5.2	Conventions	6	5.3	Boot Mode Switch.....	35
2	Introduction	7	5.4	Power Up Configuration.....	36
2.1	Safety and Handling Precautions	7	5.5	MCU programming Port.....	37
2.2	Short Description.....	8	5.5.1	MCU Pinout	39
2.3	Shipping List.....	8	6	MPX-Module	41
3	Quick Start Guide	9	6.1	Mounting/Unmounting	42
3.1	Prerequisites	9	6.2	DRAM	44
3.1.1	Minimum Requirements	9	6.3	eMMC	45
3.1.2	Recommended Items	9	6.4	Leds.....	45
3.2	Board Preparation and Power-Up	10	6.5	Switches	46
3.3	Operation	12	6.6	Module Connector	47
3.3.1	U-Boot Startup.....	12	6.7	Module/Carrier Connections	48
4	System Description.....	13	7	JTAG Chain	55
4.1	Block Diagram CRX-S32V Carrier.....	13	7.1.1	JTAG Devices.....	55
4.2	Block Diagram MPX-S32V Module.....	13	7.1.2	JTAG Connector.....	55
4.3	Feature Overview	14	7.1.3	JTAG Connector Pinout.....	56
4.4	Mechanical Dimensions	17	8	I²C Structure.....	57
4.4.1	MPX-S32V Module.....	17	8.1.1	Bus Map	57
4.4.2	CRX-S32V Carrier.....	18	8.1.2	I ² C Devices	58
4.5	Carrier Board Layout – Module Side	19	8.1.3	Digital Visual Interface.....	58
4.6	Carrier Board Layout – Non-Module Side ...	20	9	Peripherals	59
4.7	Carrier Power Button Side View	21	9.1	HDMI	59
4.8	Carrier Power Plug Side View	21	9.1.1	DDC Function	59
4.9	Carrier Bottom Side View	21	9.1.2	HDMI Connector.....	60
4.10	Carrier Top Side View	21	9.2	LAN Connection	61
4.11	Module Top Side	22	9.3	PCIe Interface.....	62
4.12	Module Bottom Side	22	9.3.1	Power Connector PWE1.....	62
4.14	System Environment	23	9.3.2	The Mini-PCIe Slot	63
4.14.1	Temperature Ratings.....	23	9.4	MIPI CSI Interface	64
4.14.2	Power Dissipation.....	25	9.4.1	MIPI Connectors.....	65
4.15	Power Supply	26	9.4.2	MIPIA Connector	66
4.15.1	Input Supply Rating.....	26	9.4.3	MIPIB Connector	67
4.15.2	Input Power Connector.....	26	9.5	MicroSD Card Slot.....	68
4.15.3	Input Power Switch.....	27	9.6	UART	70
4.15.4	Fuses	28	9.6.1	UART1	70
4.15.5	Power Supply Structure.....	28	9.6.2	UART2.....	70
			9.7	CAN	71

9.7.1	CAN0.....	71	10	Appendix	77
9.7.2	CAN1.....	71	10.1	Acronyms.....	77
9.7.3	Termination	72	10.2	Table of Figures.....	78
9.8	LEDs	73	10.3	Table of Tables.....	80
9.9	Switches.....	74	11	History	81
9.10	Jumpers	76			

1 General Notes

Copyright MicroSys Electronics GmbH, January 2017

All rights reserved. All rights in any information which appears in this document belong to MicroSys Electronics GmbH or our licensors. You may copy the information in this manual for your personal, non-commercial use.

Copyrighted products are not explicitly indicated in this manual. The absence of the copyright (©) and trademark (TM or ®) symbols does not imply that a product is not protected. Additionally, registered patents and trademarks are similarly not expressly indicated in this manual.

1.1 Warranty

To the extent permissible by applicable law all information in this document is provided without warranty of any kind, whether expressed or implied, including but not limited to any implied warranty of satisfactory quality or fitness for a particular purpose, or of non-infringement of any third party's rights. We try to keep this document accurate and up-to-date but we do not make any warranty or representation about such matters. In particular we assume no liability or responsibility for any errors or omissions in this document.

MicroSys Electronics GmbH neither gives any guarantee nor accepts any liability whatsoever for consequential damages resulting from the use of this manual or its associated product.

MicroSys Electronics GmbH further reserves the right to alter the layout and/or design of the hardware without prior notification and accepts no liability for doing so.

1.2 Links

We make no warranty about any other sites that are linked to or from this document, whether we authorize such links or not.

1.3 Liability

To the extent permissible by applicable law, in no circumstance, including (but not limited to) negligence, shall we be liable for your reliance on any information in this document, nor shall we be liable for any direct, incidental, special, consequential, indirect or punitive damages nor any loss of profit that result from the use of, or the inability to use, this document or any material on any site linked to this document even if we have been advised of the possibility of such damage. In no event shall our liability to you for all damages, losses and causes of action whatsoever, whether in contract, tort (including but not limited to negligence) or otherwise exceed the amount, if any, paid by you to us for gaining access to this document.

MicroSys Electronics GmbH
Muehlweg 1
D-82054 Sauerlach
Germany

Phone: +49 8104 801-0
Fax: +49 8104 801-110

1.4 Offer to Provide Source Code of Certain Software

This product contains copyrighted software that is licensed under the General Public License (“GPL”) and under the Lesser General Public License Version (“LGPL”). The GPL and LGPL licensed code in this product is distributed without any warranty. Copies of these licenses are included in this product.

You may obtain the complete corresponding source code (as defined in the GPL) for the GPL Software, and/or the complete corresponding source code of the LGPL Software (with the complete machine-readable “work that uses the Library”) for a period of three years after our last shipment of the product including the GPL Software and/or LGPL Software, which will be no earlier than December 1, 2010, for the cost of reproduction and shipment, which is dependent on the preferred carrier and the location where you want to have it shipped to, by sending a request to:

MicroSys Electronics GmbH
Muehlweg 1
D-82054 Sauerlach
Germany

In your request please provide the product name and version for which you wish to obtain the corresponding source code and your contact details so that we can coordinate the terms and cost of shipment with you.

The source code will be distributed WITHOUT ANY WARRANTY and licensed under the same license as the corresponding binary/object code.

This offer is valid to anyone in receipt of this information.

MicroSys Electronics GmbH is eager to duly provide complete source code as required under various Free Open Source Software licenses. If, however you encounter any problems in obtaining the full corresponding source code we would be much obliged if you give us a notification to the email address gpl@microsys.de, stating the product and describing the problem (please do NOT send large attachments such as source code archives etc. to this email address)

1.5 Symbols, Conventions and Abbreviations

1.5.1 Symbols

Throughout this document, the following symbols will be used:



Information marked with this symbol **MUST** be obeyed to avoid the risk of severe injury, health danger, or major destruction of the unit and its environment



Information marked with this symbol **MUST** be obeyed to avoid the risk of possible injury, permanent damage or malfunction of the unit.



Information marked with this symbol gives important hints upon details of this manual, or in order to get the best use out of the product and its features.

Table 1 Symbols

1.5.2 Conventions

Symbol	explanation
#	denotes a low active signal
←	denotes the signal flow in the shown direction
→	denotes the signal flow in the shown direction
↔	denotes the signal flow in both directions
→	denotes the signal flow in the shown direction with additional logic / additional ICs in the signal path
I/O	denotes a bidirectional pin
Input	denotes an input pin
matched	denotes the according signal to be routed impedance controlled and length matched
Output	denotes an output pin
Pin 1	refers to the numeric pin of a component package
Pin a1	refers to the array position of a pin within a component package
XXX-	denotes the negative signal of a differential pair
XXX+	denotes the positive signal of a differential pair
XXX	denotes an optional not mounted or fitted part

Table 2 Conventions

2 Introduction

Thank you for choosing the MicroSys SBC-S32V Single Board Computer system. This manual should help you to get the best performance and details out all of its features.

2.1 Safety and Handling Precautions



ALWAYS use the correct type and polarity of the power supply!

DO NOT exceed the rated maximum values for the power supply! This may result in severe permanent damage to the unit, as well as possible serious injury.

ALWAYS keep the unit dry, clean and free of foreign objects. Otherwise, irreparable damage may occur.



Parts of the unit may become hot during operation. Take care not to touch any parts of the circuitry during operation to avoid burns, and operate the unit in a well-ventilated location. Provide an appropriate cooling solution as required.



ALWAYS take care of ESD-safe handling!

Many pins on external connectors are directly connected to the CPU or other ESD sensitive devices.

Make or break ANY connections ONLY while the unit is switched OFF.

Otherwise, permanent damage to the unit may occur, which is not covered by warranty.



There is no separate SHIELD connection.

All the metal sheaths of shielded connectors are connected to GND.

Also, all mounting holes of the carrier board are connected to GND.

The module's mounting holes are not connected to GND. Take this into account when handling and mounting the unit.

Table 3 Safety and Handling Precautions

2.2 Short Description

The SBC-S32V is a small computer system consisting of

- the MPX-S32V module, based on NXP's S32V234 vision processing MPU
- the CRX-S32V carrier board.

It targets both

- evaluation of the MPX-S32V SOM
- direct usage as an industrial ADAS computing solution

This document provides you an overview on the system devices, connectors and functions, and how to take the first steps on the initial setup.

2.3 Shipping List

The SBC-S32V EvalKit package contains the following items:

- The SBC-S32V system, mounted with cooling solution
- Power Supply 12V DC stabilized / 2 A
- Micro-SD-Card with U-Boot and root file system

3 Quick Start Guide

3.1 Prerequisites



Always make sure to handle the SBC-S32V unit ESD-safe! Otherwise, the unit may suffer permanent damage. However, do not place the unit directly flat on a metal surface, as this may result in short circuits and damage to the board.

At first time operation unpack the unit and make sure that is clean and free of visible damage or foreign objects.

3.1.1 Minimum Requirements

To operate the board, you will at least need the following items:

- an adequate power supply, delivering 12V DC (stabilized) / 2 A min.
- an USB cable (type A – micro B) adapted to connector USB
- a serial terminal, such as a PC with an USB port running a terminal Software (e.g. TeraTerm, HyperTerminal, putty, Kermit...), or else a hardware serial console. **Choose the following parameters:**
 - (a) **115200 Bd**
 - (b) **8 Data bits**
 - (c) **No parity**
 - (d) **1 Stop Bit**

3.1.2 Recommended Items

The following items are not absolutely necessary, but strongly recommended for practical operation and development purposes:

- Network connection via LAN port (RJ45) to your local network installation
- TFTP server available for downloading within the network (Hint: may run on the same PC as the serial Terminal)
- SD card as mass storage and/or boot media

3.2 Board Preparation and Power-Up

- Make sure the switch BOOT, located on the CRX-S32V carrier board, is set properly in order to select the correct boot source and board configuration. For more details see chapter 5.3 Boot Mode Switch

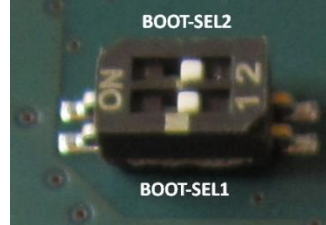


Figure 1 BOOT Switch

- Make sure the switch BMD, located on the MPX-S32V module, is set properly in order to select the correct boot source. For more details see chapter 5.2 Boot Mode Configuration

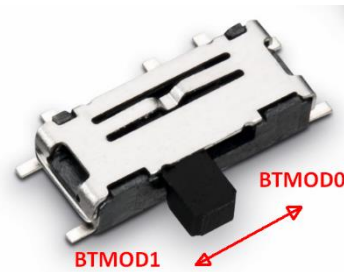


Figure 2: BMD Switch

- Make sure the switch GPU, located on the MPX-S32V module, is set properly in order to select the correct GPU supply. For more details see chapter 6.5 Switches



Figure 3: GPU Switch

- The board comes preconfigured to boot correctly via SD-Card on arrival.
- Connect the micro USB cable to USB.

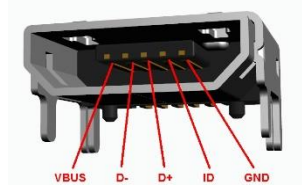


Figure 4 USB Connector

- Connect other peripherals as far as intended.
- Make sure the power switch PWR is in off position (released)

Figure 5 Power Switch Off



- Connect the 12V power line to the PWRA connector



Figure 6 Power Jack

- Switch on the power by switch PWR

Figure 7 Power Switch ON



**After Power-On, the green LED on the carrier should light up.
IF NOT, DISCONNECT THE UNIT IMMEDIATELY FROM THE POWER SOURCE AND CHECK FOR FAULTS!**

3.3 Operation

3.3.1 U-Boot Startup

When power is supplied the system will start.

On startup, U-Boot will come up similar to the following:



NOTE

The exact output may vary, depending on U-Boot and MPX-S32V module versions in use.

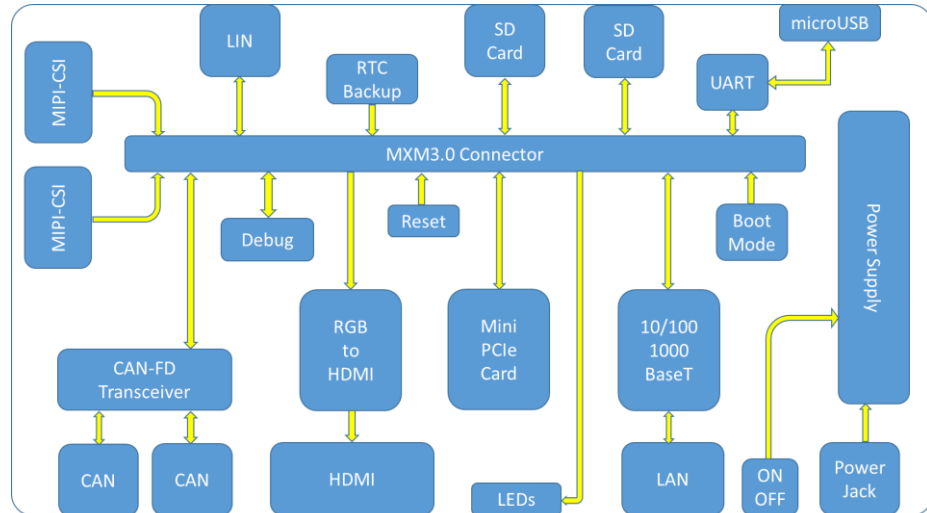
```
U-Boot 2016.01 (Aug 04 2017 - 09:06:53 +0200)
```

```
CPU:   NXP S32V234 at 1000 MHz
Reset cause: unknown reset
Board: mpxs32v234-R2
I2C:   ready
DRAM:  2 GiB
All (4) cores are up.
MMC:   FSL_SDHC: 0
In:    serial
Out:   serial
Err:   serial
Net:   FEC
=>
```

4 System Description

This section describes all parts of the SBC-S32V system.

4.1 Block Diagram CRX-S32V Carrier



4.2 Block Diagram MPX-S32V Module



4.3 Feature Overview

Feature	Type	Description
CPU	NXP S32V234	CoreClock 1GHz Quad-Cortex®-A53 Single-Cortex®-M4
SDRAM	Dual 32-bit DDR3L interface	2 x up to 1GByte up to 1066MT/s
Mass Storage	8-bit eMMC	16 GByte
PCI Express	miniPCIe Slot	Rev.2.0 5Gbps Lane x1 RC/EP 100MHz Clock Source I2C support
Removable Media	eSDHC-I / (eSDHC-II)	micro SD card holders 4bit support
Ethernet	RGMII	KSZ9031RN Phy 10/100/1000 BaseT Link/ Activity Leds
Grahics Output	TFP410	HDMI Type A DDC support
Video Input	MIPI-CSI-A	5V/12V supply 4 Lanes + Clock 27MHz Ref Clock Mounting Holes
	MIPI-CSI-B	5V/12V supply 4 Lanes + Clock 27MHz Ref Clock Mounting Holes
Serial Interfaces	UART0	USB to serial Converter USB-powered micro USB Type B
	UART1	LIN 2.1 interface MC33662BLEF
CAN Interface	CAN-FD-1	TJA1051 120R Termination CML Filter ESD Protection
	CAN-FD-2	TJA1051 120R Termination CML Filter ESD Protection
RTC	Time/Date	PCF85263A 2032 coin cell backup
Board Control	S9KEAZN64A	Voltage supervision Reset logic Boot configuration Status led
Board Switches	Modul Switches	RCON/Serial Select GPU Power Off

Feature	Type	Description
	Carrier Switches	Power On/Off Reset Button Boot Mode 1 Boot Mode 2 CAN1 Termination On/Off CAN2 Termination On/Off
Board Connectors	Modul Connectors	ADC Channel 0-7 MCU Programming Port
	Carrier Connectors	12V Power Input 5V/12V Aux Power Out 5V/12V Fan Power Out 314 pin MXM Connector microSD-A microSD-B (not mounted) miniPCIe microUSB RJ45 LAN HDMI Out MIPI-A MIPI-B CAN-A CAN-B LIN Interface JTAG
Indicators	Module Leds	MCU Status Reset Status User GPIO1 User GPIO2
	Carrier Leds	12V Power Indicator User Led 1 User Led 2
Debug	JTAG	10 pin Header
Power Management	System On/Off	Pushbutton Switch
	Input Voltage	12V DC
	Input Current	typical. <1A, no loads
	Supply Polarity	Reverse voltage protected
	Oversvoltage	TVS protected
	Input Fuse	3A PPTC type
	Module POL regulators	1.0V, max 10A 1.35V, max.6A 1.8V, max 3A 3.3V, max 3A
	Carrier POL regulators	1.5V,max.3A 3.3V, max 3A 5.0V, max 3A
	RTC Backup	2032 coin cell
Shielding	Connector Shield	connected to Ground
	ESD Discharge	connected to Ground
Mechanics	Dimension	93x126mm

Feature	Type	Description
	Module Mounting	4 Mounting Holes, 2.5mm Ø all electrically floating
	Carrier Mounting	4 Mounting Spacers, M2.5 2 Holes electrically floating 2 Holes electrically grounded
	miniPCle Mounting	2 Mounting Spacers, M2.5 all electrically grounded
	MIPI-A Mounting	2 Mounting Holes, 3.2mm Ø all electrically grounded
	MIPI-B Mounting	2 Mounting Holes, 3.2mm Ø all electrically grounded

4.4 Mechanical Dimensions

4.4.1 MPX-S32V Module

The following drawing shows the mechanical outline of the MPX-S32V module that is plugged in the CRX-S32V carrier board.



This drawing is not to scale.



For 3D data files please contact MicroSys.



Figure 8 Mechanical Dimensions

4.4.2 CRX-S32V Carrier

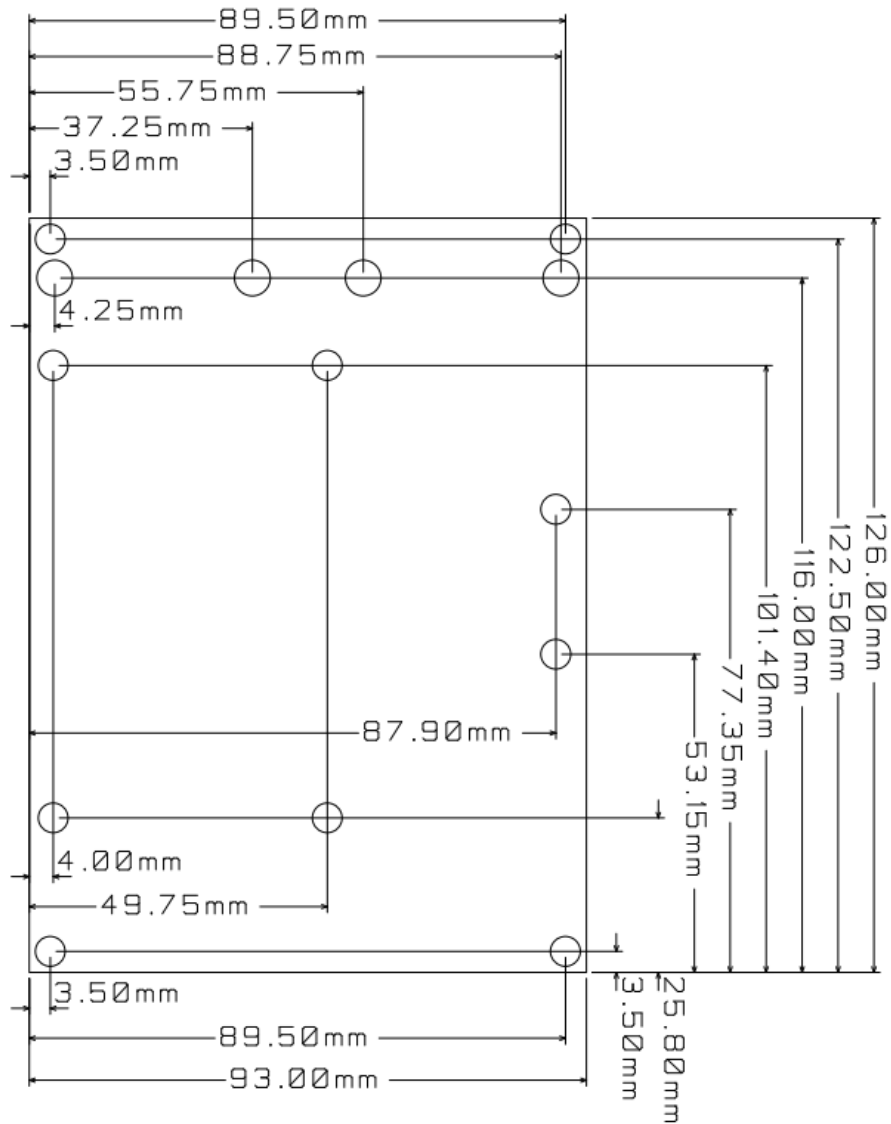
The following drawing shows the mechanical outline of the SBC-S32V assembly.



This drawing is not to scale.



For 3D data files please contact MicroSys.



4.5 Carrier Board Layout – Module Side

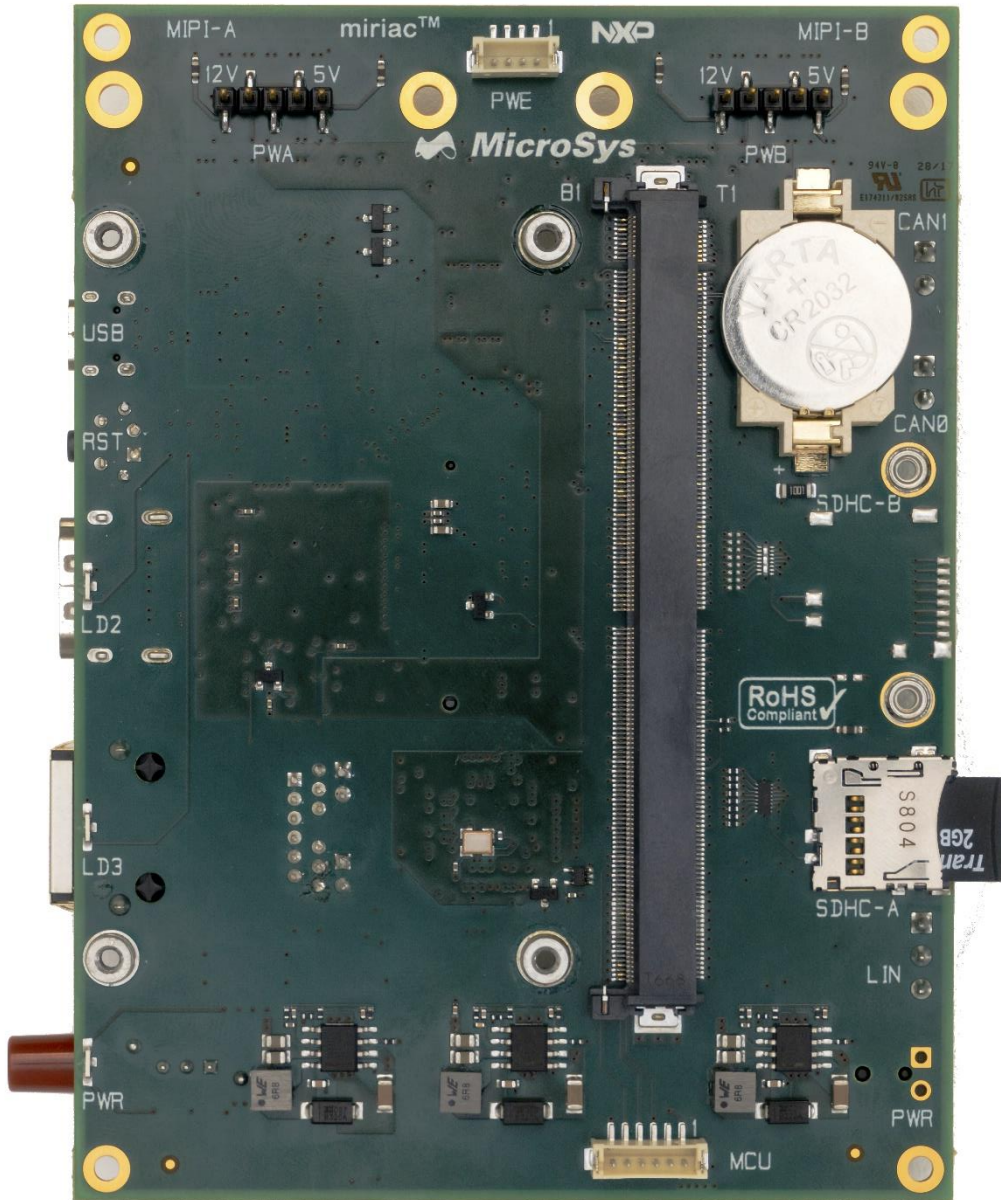


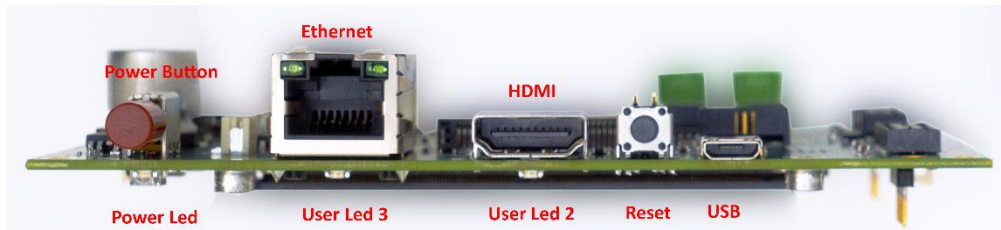
Figure 9: Module Side connectors (carrier CRX-S32V)

4.6 Carrier Board Layout – Non-Module Side

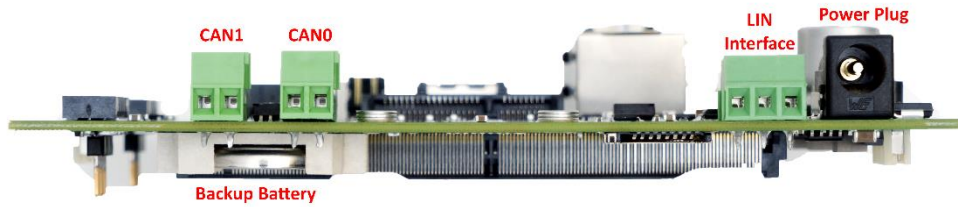


Figure 10 Non-Module Side connectors (carrier CRX-S32V)

4.7 Carrier Power Button Side View



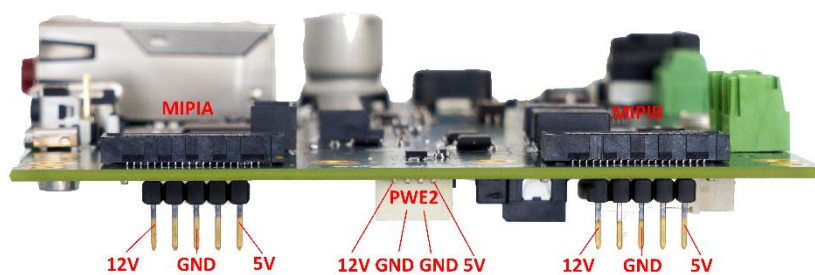
4.8 Carrier Power Plug Side View



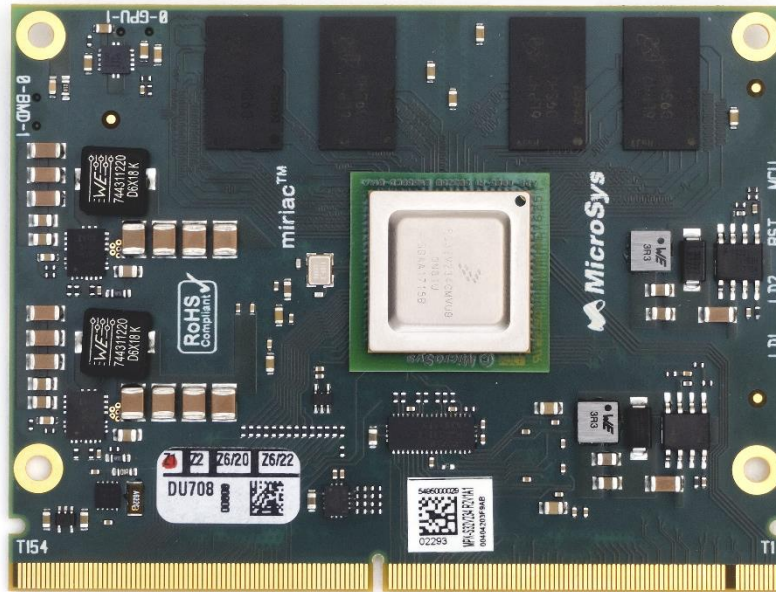
4.9 Carrier Bottom Side View



4.10 Carrier Top Side View



4.11 Module Top Side



4.12 Module Bottom Side



4.14 System Environment

4.14.1 Temperature Ratings

The SBC-S32V contains parts with the following ambient, junction or case temperature ratings. Due to these limits, the system function is only guaranteed, if none of them are exceeded at any time. The heatsink of the MPX-S32V requires an adequate air flow, which can be accomplished by free or forced air convection.

If an active cooling is desired, a fan can be connected to one of the power connectors PWE1 or PWE2, which provide +5.0V as well as +12V.

Part	Tmin	Tmax
BAT-CR2032MFR-1BL	-30°C	70°C
BAT-HOLDER-79527141	-55°C	85°C
C-0402-NP0-Series	-55°C	125°C
C-0402-X5R-Series	-55°C	85°C
C-0402-X7R-Series	-55°C	125°C
C-0603-226-X5R-Z	-55°C	85°C
C-0603-X7R-Series	-55°C	125°C
C-0805-X7R-Series	-55°C	125°C
C-1206-X7R-Series	-55°C	125°C
C-EEEFK1H331AQ	-55°C	105°C
CML-744-227	-40°C	125°C
CML-744-233-670	-40°C	85°C
D-B320A-13-F	-55°C	150°C
D-BAS70	-65°C	150°C
D-BAT54S	-55°C	125°C
D-SD2114S040S5R0	-55°C	125°C
FB-742-792-XXX	-55°C	125°C
HEADER-2.54-180-M-1X2	-40°C	125°C
HEADER-2.54-180-SM-1X5	-40°C	163°C
IC-BTS462T	-40°C	150°C
IC-DSC1001CI2-027.0000	-40°C	85°C
IC-DSC557-0344FI1	-40°C	85°C
IC-FT232RQ	-40°C	85°C
IC-IR347xMTRPBF	-40°C	125°C
IC-KSZ9031RNXIA	-40°C	85°C
IC-MAX4886ETO	-40°C	85°C
IC-MC33662BLEF	-40°C	125°C
IC-MT41K256M16HA-107-IT	-40°C	95°C
IC-MTFC16GAKAENA-4M-IT	-40°C	85°C
IC-NCV8715SQ50T2G	-40°C	125°C

Part	Tmin	Tmax
IC-PCA9517ADP	-40°C	85°C
IC-PCF85263ATL	-40°C	85°C
IC-PS32V234CMN0VUB	-40°C	125°C
IC-REF3030AIDBZ	-40°C	125°C
IC-S9KEAZN64AMLH	-40°C	85°C
IC-SN74LVC1G04DCK	-40°C	85°C
IC-SN74LVC1G125DCK	-40°C	125°C
IC-SN74LVC244ARGYR	-40°C	125°C
IC-TFP410PAP	0°C	70°C
IC-TJA1051T	-40°C	105°C
IC-TPS22920LYZP	-40°C	85°C
IC-TPS51200DRC	-40°C	85°C
IC-TPS5433xDDAR	-40°C	150°C
IC-TPS70933DBV	-40°C	125°C
L-744-311-220	-55°C	125°C
L-744-383-56033	-40°C	85°C
L-744-383-57068	-40°C	85°C
L-744-771-001	-55°C	125°C
LD-155124xx73200	-40°C	85°C
PCB-ADP-8065-01	-40°C	85°C
PCB-CRX-S32V-01	-40°C	85°C
PCB-MPX-S32V-02	-40°C	85°C
PTC-2920L330/24	-40°C	85°C
R-0402-Serie	-55°C	155°C
R-0603-Serie	-55°C	155°C
R-0805-Serie	-55°C	155°C
R-1206-Serie	-55°C	155°C
R-2010-Serie	-55°C	155°C
RC-IP4252CZ16-8	-40°C	85°C
ST-JAE-MM70-314-310-B1-1	-40°C	85°C
ST-JST-SM06B-XSRS-ETB	-25°C	85°C
ST-SAM-QSE-020-01-F-D	-55°C	125°C
ST-SAM-SHF-105-01-L-D-SM	-55°C	125°C
ST-TYCO-2041119-1-PCIe	-55°C	85°C
ST-WE-629-105-150-521	-40°C	85°C
ST-WE-679-30x-124-022	-25°C	85°C
ST-WE-685-119-134-923	-25°C	85°C
ST-WE-687-118-140-22	-25°C	85°C
ST-WE-691-214-110-00x	-40°C	105°C
ST-WE-694-106-106-102	-40°C	85°C

Part	Tmin	Tmax
ST-WE-749-911-1221A	0°C	70°C
ST-YE-PJS-008-2130-0	-25°C	85°C
SW-CK-G003R	-10°C	60°C
SW-CK-PN12SHSA03QE	-10°C	60°C
SW-WE-416-131-160-802	-40°C	85°C
SW-WE-431-256-038-716	-40°C	85°C
SW-WE-450-404-015-514	-40°C	85°C
T-BSS138LT1	-55°C	150°C
T-FDT434P	-55°C	150°C
T-PDTA114YT	-55°C	150°C
T-PDTC123JT	-65°C	150°C
TVS-1.5SMC15AT3	-65°C	150°C
TVS-ESD7504MUTAG	-55°C	125°C
TVS-PSOT36LC	-55°C	150°C
TVS-USBLC6-2P6	-40°C	125°C
XT-FT13A-xx.00000/8-20-20/48	-40°C	85°C
XT-FT26A-32.7680/12.5-20/48	-40°C	85°C
Y-WE-977-403-0151-M25-3MM00	-55°C	125°C

4.14.2 Power Dissipation

Component	max. Temperature	Power Dissipation
CPU	T _j 125° C	7W
DDR	T _c 95° C	1.5W
Core Regulator	T _j 125° C	1.2W
DDR Regulator	T _j 125° C	0.3W
eMMC	T _a 85° C	0.5W
LAN	T _j 125° C	0.9W
HDMI	T _a 70° C	0.9W

(j=junction, c=case, a=ambient)

4.15 Power Supply

4.15.1 Input Supply Rating

The SBC-S32V system is run from a single power supply with the following ratings:

Input Voltage Operating Range:	12V DC +/-5%
Typical Current Consumption (@12V / room temperature / U-boot prompt):	0,40A

The input of the SBC-S32V system is protected against wrong polarity and over current



DO NOT exceed the rated maximum values for the power supply! This may result in severe permanent damage to the unit, as well as possible serious injury.

4.15.2 Input Power Connector

Power is fed to the unit via the 2-pin DC power jack PWRA

Manufacturer:	Würth Elektronik
Type:	694-106-106-102
Mates with:	dc power plug 5.5mm x 2.5mm

Figure 4-6 Power Jack



4.15.3 Input Power Switch

The unit can be switch on and off by a push button switch. The switch controls all on system supply rails via a high side power switch. The silicon switch has a nominal load current of 3.5A, an on-state resistance of 100mR and it is fully protected against current and thermal overload.

The push button switch has two alternate positions, i.e. pressed and released. The position of the switch sets the power state of the SBC-S32V system. It will not be reset, in case the power cord is disconnected. The switch can be optionally equipped with various switch caps in form and color

Manufacturer:	C&K-Components
Type:	PN12SHSA03QE
Mates with:	G001/2/3/4-A/G/I/R

Figure 12: G003-Series



Figure 11:PN12SHSA03QE



4.15.4 Fuses

There is a PPTC fuse on the SBC-S32V.

The part is a self-resettable fuse with a nominal current rating of 3.3A at 20°C ambient temperature. The current is derated due to the ambient temperature according to the following table:

-40°C	-20°C	0°C	20°C	40°C	50°C	60°C	70°C	85°C
4,7A	4,2A	3,8A	3,3A	2,9A	2,6A	2,3A	1,9A	1,6A

Figure 4-7 Fuse Derating

4.15.5 Power Supply Structure



Figure 13 Power supply structure

4.15.6 Power Distribution

There are two power connectors available onboard the SBC-S32V. These 4 pin shrouded header connectors can be used to connect an external fan or for additional supply voltages required for miniPCIe modules. The current rating is limited to 1A per pin. The voltages are switched on and off by the main power switch. The +12V voltage is sourced by the input voltage, which is derated by maximal 550mV, caused by the input polarity protection diode. An external load must not feed in any reverse current or voltage during any power state, f.e. an external inductive load must be equipped with a freewheeling circuit.

Manufacturer:	Würth
Type:	679304124022
mates with:	648004113322



Figure 14: Connector PWE1 & PWE2

4.15.7 MIPI Power

The two MIPI ports of the SBC-S32V system can be either work with 5.0V only or mixed with +5.0V and +12V. This option is handled by two 5 pin 2.54mm headers.

Manufacturer:	Fischerelektronik
Type:	SL10SMD0525G
mates with:	2.54mm Jumper Link



Figure 15: Header PWA & PWB

PWA	Signal	Description
1	+5.0V	Power Rail
2	VCCA	Supply for MIPIA Pin 25 & 27
3	GND	Ground
4	VCCA	Supply for MIPIA Pin 25 & 27
5	+12V	Power Rail

PWB	Signal	Description
1	+5.0V	Power Rail
2	VCCB	Supply for MIPIB Pin 25 & 27
3	GND	Ground
4	VCCB	Supply for MIPIB Pin 25 & 27
5	+12V	Power Rail

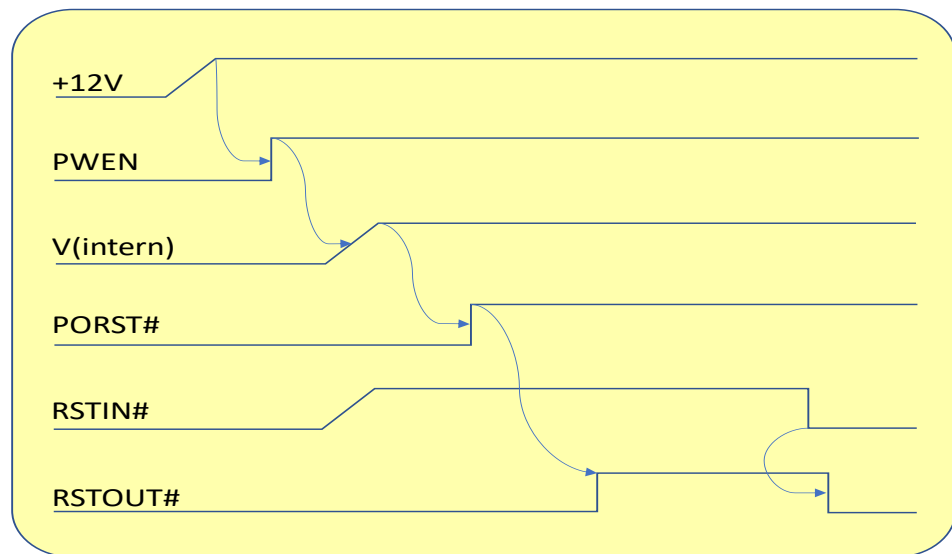
In case the pins 25 and 27 should not be powered, no link at all should be installed. If these pins should be grounded, a link between pin 2 and 3 or 3 and 4 must be set.



Anyway, only a single link per header must be set at a time. More than one link installed may cause permanent damage to the board!

4.15.8 Power Up

During a power up sequence, the MCU first checks the input voltage to be within their necessary limits. After that, the POL (Point Of Load) regulators on the module will be activated as well as the tracking regulators for 5V, 3.3V and 1.5V on the carrier board. If all module voltages are o.k. the reset sequence will be started. If there is no external reset request, f.e. via RSTIN# from the reset key, the RESET# will be released after 100ms. A low level on the RSTIN# line extends this time. During normal operation, a falling edge at RSTIN# initiates a reset sequence for the whole system, which is at least 100ms long. As long the reset key is pressed, the system will be held in the reset state. If the key is released, the CPU will fetch its power up configuration and starts up with its BIST and/or boot sequence. The RSTOUT# signal will directly follow the state of the RESET# signal. As long the RSTOUT# is active all connected devices must be held in a reset state in order not to block the power up configuration settings.



In case the MCU detects any overvoltage, it will turn off all internal point of load regulators. The external supply voltage is reverse polarity protected and limited by a 15V transient voltage suppressor diode to protect the system. The input poly fuse is rated for a maximum voltage of 24V, i.e. any voltage above that limit will destroy the input protection of the system.

4.16 Reset Structure



Figure 4-3 Reset Structure

Signal Name	Function	Type
RSTIN#	System Global Reset Input	4K7 Pullup
RSTOUT#	System Global Reset Output	Totem Pole
PORST#	Power-On Reset for CPU	Totem Pole
RESET#	Reset for CPU	Open Drain
FRSTI#	Reset for eMMC device	Totem Pole
M0RST#	Reset for Memory Bank 0	Totem Pole
M1RST#	Reset for Memory Bank 1	Totem Pole
(# denotes an active low signal)		

Table 4-3 Reset signal overview

5 System Core, Boot Configuration

5.1 Processor NXP S32V234

The S32V234 is a vision processing MPU with four ARM® Cortex®-A53 cores and a single Cortex-M4 core. The four CPU cores run at a maximum clock speed of 1000MHz.

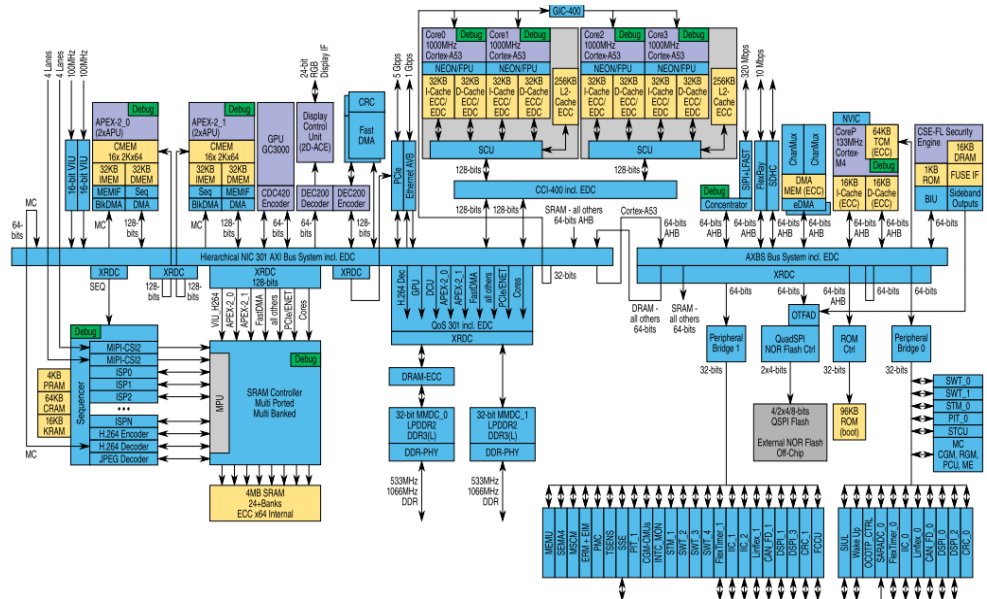


Figure 4-7 Processor Block diagram

5.2 Boot Mode Configuration

The SBC-S32V board offers several different boot modes to choose from. The settings can be done via the sliding switch BMD on the module and the dipswitch BOOT on the carrier according to following table.

The switch BMD sets the BMODE[0] and BMODE[1] signals of the CPU to low, while the two configuration resistors BMD0 and BMD1 are used to set a fixed low value on these lines.

The parts BMD, BMD0 and BMD1 are located on the MPX-S32V module.

Boot Mode	BMD-Switch	BMD0 ¹⁾	BMD1 ¹⁾
Serial Download, virgin device	No function	installed	installed
Serial Download, virgin device	Position 0	removed	installed
Serial Download, prog. device	Position 1	removed	installed
RCON Boot, if no fuses	Position 0	installed	removed
Serial Download, prog. device	Position 1	installed	removed
RCON Boot, no fuses	Position 0	removed	removed
Serial Download, prog. device	Position 1	removed	removed

green denotes the default configuration

Note 1) BMD0 and BMD1 are soldered resistors (size 0402) and not intended to be changed by user.



Figure 16: BMD Switch

Shown positions set the according BTMOD0/1 line to low. BTMOD0 controls the CPU configuration port PC9, i.e. BOOTMOD(0), while BTMOD1 is connected to the CPU configuration port PC10, i.e. BOOTMOD(1).



Figure 18: Position BTM1=low

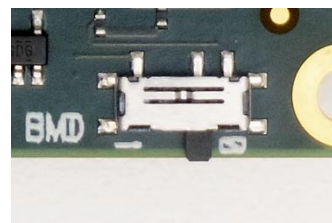


Figure 17: Position BTM0=low

5.3 Boot Mode Switch

The boot mode switch BOOT located on the CRX-S32V, allows the following default boot modes, in case the BMD switch is set to position RCON. If the BMD switch is set to serial download, the BOOT switch has no function.

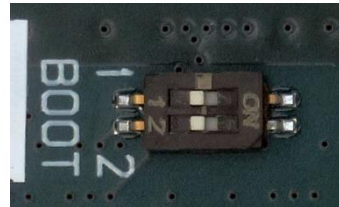






Figure 19: Boot Mode Switch

Setting	BOOT-SEL1	BOOT-SEL2	Boot Device
	OFF	OFF	Cortex A53 via SDHC-A
	ON	OFF	Cortex A53 via eMMC
	OFF	ON	Cortex M4 via SDHC-A
	ON	ON	Cortex M4 via eMMC

green denotes the default configuration

In case, the eMMC or the SDHC-Slot should be used after a boot from the other device, the Boot Mode Switch 1 must be set to either position and the “MMC RESCAN” command must be executed within u-boot. The “MMC INFO” command will then show the new active storage device.

5.4 Power Up Configuration

The S32V234 is configured during power up by the state of 32 I/O signals, which are controlled by the MCU. Within the MCU, the four most popular RCON boot configurations are implemented and can be selected via the dip-switch BOOT placed on the carrier board.



These configurations are only valid, if the Boot Mode Configuration is set to RCON Boot!

Signal	RCON	Port	eSDHC Mode	eMMC Mode
FLXR-TENB	RCON[0]	PA[7]	0	0
FLXR-TXD	RCON[1]	PA[8]	0	0
FLXR-RXD	RCON[2]	PA[9]	0	0
UART0-RXD	RCON[3]	PA[11]	0	0
UART0-TXD	RCON[4]	PA[12]	0	1
UART1-RXD	RCON[5]	PA[13]	0	0
UART1-TXD	RCON[6]	PA[14]	0	1
I2C0-SDA	RCON[7]	PA[15]	1	1
I2C0-SCL	RCON[8]	PB[0]	0	0
I2C1-SDA	RCON[9]	PB[1]	0	0
I2C1-SCL	RCON[10]	PB[2]	0	0
I2C2-SDA	RCON[11]	PB[3]	0	1
SPI0-SCK	RCON[12]	PB[5]	0	0
SPI0-SOUT	RCON[13]	PB[6]	0	0
SPI0-SIN	RCON[14]	PB[7]	0	0
SPI0-CS0#	RCON[15]	PB[8]	0	1
SPI1-SCK	RCON[16]	PB[9]	0	1
SPI1-SOUT	RCON[17]	PB[10]	0	0
SPI1-SIN	RCON[18]	PB[11]	0	0
SPI1-CS0#	RCON[19]	PB[12]	0	0
SPI2-SCK	RCON[20]	PB[13]	0	0
SPI2-SOUT	RCON[21]	PB[14]	1	1
SPI2-SIN	RCON[22]	PB[15]	0	0
SPI2-CS0#	RCON[23]	PC[0]	0	0
SPI3-SCK	RCON[24]	PC[1]	0	0
SPI3-SOUT	RCON[25]	PC[2]	0	0
SPI3-SIN	RCON[26]	PC[3]	0	0
SPI3-CS0#	RCON[27]	PC[4]	0	0
FXT0-CH0	RCON[28]	PC[5]	0	0
FXT0-CH1	RCON[29]	PC[6]	0	0
FXT0-CH2	RCON[30]	PC[7]	0	0
FXT0-CH3	RCON[31]	PC[8]	1	1

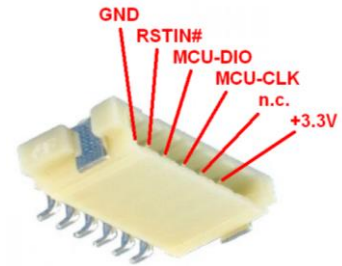
5.5 MCU programming Port

The MCU, a Kinetis S9KEAZN64AMLH, controls the power on and the reset sequence. It monitors all module generates supply voltages and drives all configuration lines of the S32V234 CPU. The controller can be either programmed via a module connector or a connector on the carrier board, both named MCU. As the module connector is very tiny and has a pitch of 0.6mm, the carrier located connector with its 1.5mm pitch should be preferred.

MPX-S32V Connector MCU

Manufacturer:	JST
Type:	SM06B-XSRS-ETB
mates with:	06XSR-36S

Figure 20: Module MCU Connector

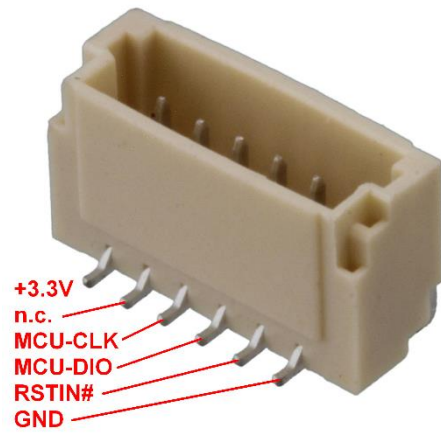
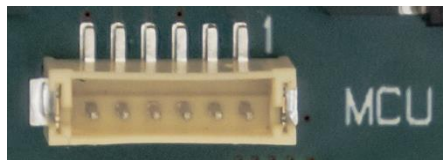


The module connector is supplied by the direct MCU supply with 3.3V, while the +3.3V supply of the carrier located connector is derived from a carrier located supply, which can be disabled by the MCU. If the MCU has configured the board with PWEN off, no supply is available on the carrier and its connectors. In this case the module connector must be used for programming or the IO voltage of the programmer is externally set to 3.3V.

CRX-S32V Connector MCU

Manufacturer:	Würth
Type:	679306124022
mates with:	648006113322

Figure 21: Carrier MCU Connector



5.5.1 MCU Pinout

MCU			Board	S32V234		Function
Pin	Port	Dir	Signal	Signal	RCON	
1	PTD1	Out	BCFG23	SPI2_CS0#	RCON[23]	Configuration
2	PTD0	Out	BCFG29	FXT0_CH1	RCON[29]	Configuration
3	PTH7	Out	BCFG22	SPI2_SIN	RCON[22]	Configuration
4	PTH6	Out	BCFG6	UART1_TXD	RCON[6]	Configuration
5	PTE7	Out	RSTOUT#			Modul Rest Output
6	PTH2		n.c.			not connected
7		In	+3V3			Supply
8		In	VREFH			+3.0V
9		In	VREFL			Reference Ground
10			GND			Reference Ground
11	PTB7	Out	FRSTI#			eMMC Reset
12	PTB6	Out	PWEN			PSU enable
13			GND			Reference Ground
14	PTH1	In	QSPI-SEL	GPIO[158]		FLASH/SDHC Mux
15	PTH0	IO	TRTC#			Time Stamp RTC
16	PTE6	In	IRTC#			Interrupt RTC
17	PTE5	Out	PORST#	EXT_POR#		PowerOnReset
18	PTB5	Out	RESET#	RESET#		Reset
19	PTB4	In	FCCU-F0	FCCU_F0		Failure Check&Correction
20	PTC3	In	LD4			yellow Led
21	PTC2	In	+3V3			ADC Divider 3:4
22	PTD7	Out	NMI	NMI		Interrupt
23	PTD6	Out	FCCU-F1	FCCU_F1		Failure Check&Correction
24	PTD5	OUT	BCFGE#			Configuration Enable
25	PTC1	In	+3.3V			ADC Divider 3:4
26	PTC0	In	+1.8V			ADC direct
27	PTF7	In	+1.35V			ADC direct
28	PTF6	In	+1.0V			ADC direct
29	PTF5	In	+VIN			ADC Divider 1:11
30	PTF4	Out	BCFG2	FLXR_RXD	RCON[2]	Configuration
31	PTB3	Out	BCFG0	FLXR_TENB	RCON[0]	Configuration
32	PTB2	Out	BCFG1	FLXR_TXD	RCON[1]	Configuration
33	PTB1	Out	BCFG3	UART0_RXD	RCON[3]	Configuration
34	PTB0	Out	BCFG4	UART0_TXD	RCON[4]	Configuration
35	PTF3	Out	BCFG7	I2C0_SDA	RCON[7]	Configuration
36	PTF2	Out	BCFG8	I2C0_SCL	RCON[8]	Configuration
37	PTA7	Out	BCFG9	I2C1_SDA	RCON[9]	Configuration
38	PTA6	Out	BCFG10	I2C1_SCL	RCON[10]	Configuration
39	PTE4	Out	BCFG14	SPIO_SIN	RCON[14]	Configuration
40			GND			Reference Ground

MCU			Board	S32V234		Function
41		In	+3V3			Supply
42	PTF1	Out	BCFG15	SPI0_CS0#	RCON[15]	Configuration
43	PTF0	Out	BCFG12	SPI0_CLK	RCON[12]	Configuration
44	PTD4	Out	BCFG13	SPI0_SOUT	RCON[13]	Configuration
45	PTD3	Out	BCFG24	SPI3_CLK	RCON[24]	Configuration
46	PTD2	Out	BCFG5	UART1_RXD	RCON[5]	Configuration
47	PTA3	Out	BCFG25	SPI3_SOUT	RCON[25]	Configuration
48	PTA2	Out	BCFG18	SPI1_SIN	RCON[18]	Configuration
49	PTA1	Out	BCFG17	SPI1_SOUT	RCON[17]	Configuration
50	PTA0	Out	BCFG31	FXT0_CH3	RCON[31]	Configuration
51	PTC7	Out	BCFG26	SPI3_SIN	RCON[26]	Configuration
52	PTC6	Out	BCFG30	FXT0_CH2	RCON[30]	Configuration
53	PTE3	Out	BCFG11	I2C2_SDA	RCON[11]	Configuration
54	PTE2	Out	BCFG16	SPI1_CLK	RCON[16]	Configuration
55	PTG3	Out	BCFG19	SPI1_CS0#	RCON[19]	Configuration
56	PTG2	Out	BCFG21	SPI2_SOUT	RCON[21]	Configuration
57	PTG1	Out	BCFG28	FXT0_CH0	RCON[28]	Configuration
58	PTG0	Out	BCFG27	SPI3_CS0#	RCON[27]	Configuration
59	PTE1	Out	BCFG20	SPI2_CLK	RCON[20]	Configuration
60	PTE0	In	BOOT-SEL1			Boot Mode
61	PTC5	In	BOOT-SEL2			Boot Mode
62	PTC4	In	MCU-CLK			Programming Interface
63	PTA5	In	RSTIN#			Programming Interface
64	PTA4	IO	MCU-DIO			Programming Interface

6 MPX-Module

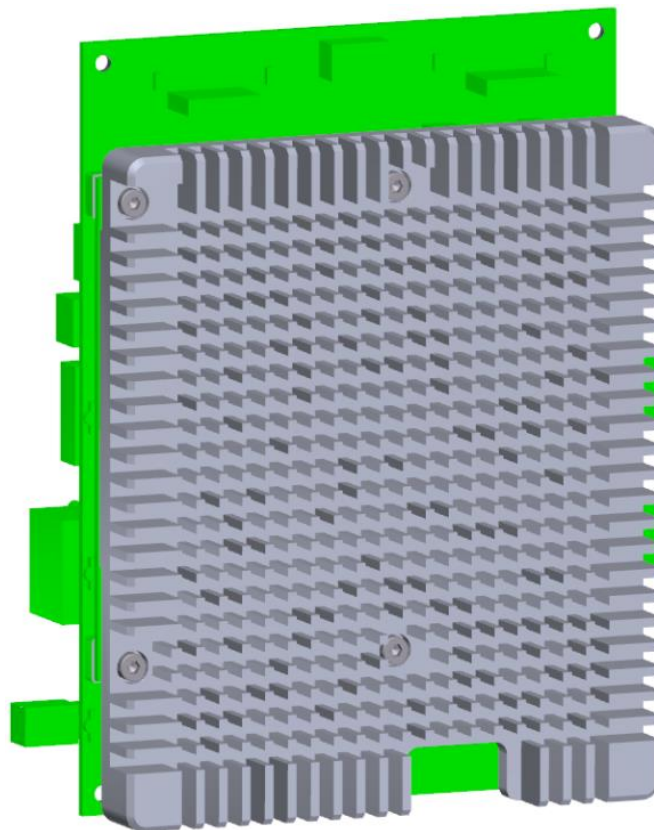
The MPX-S32V miriac module fits in the MXM connector of the CRX-S32V carrier board. It must be mounted with a heatsink and is fixed with 4 Torx screws M2.5x16.

The SBC-S32V is designed to stand in an upright position with the two MIPI camera connectors on top and the heatsink as vertical support.

The recess at the bottom of the heatsink allows for an access to the MCU programming port.

In case, an active cooling is desired, the top middle connector PWE2 provides +5.0V and +12V.

All other connections and controls are located on the left and right vertical side of the system.



6.1 Mounting/Unmounting

The mounting or unmounting of the module should only be made in a static free area with full ESD precautions, i.e. as a minimum, a grounded dissipative work surface of sufficient size and a grounded skin contact wrist strap are necessary. Make sure, that all parts, the carrier, the module and the heatsink are placed on the same static free area to avoid any discharges between them during assembly.

To mount the MPX-S32V module, make sure that the carrier is disconnected from any power or other IO interfaces. Both connector surfaces of the module must be clean as well as the carrier connector should be checked for bent or dirty contacts. Check the module and the carrier for foreign or loose parts, which do not belong to the boards. The screws should have clean threads and be tightened with a maximum torque of 30Ncm.

Insert or remove the MPX-S32V module always by an angle of about 25° like shown in the following figure.

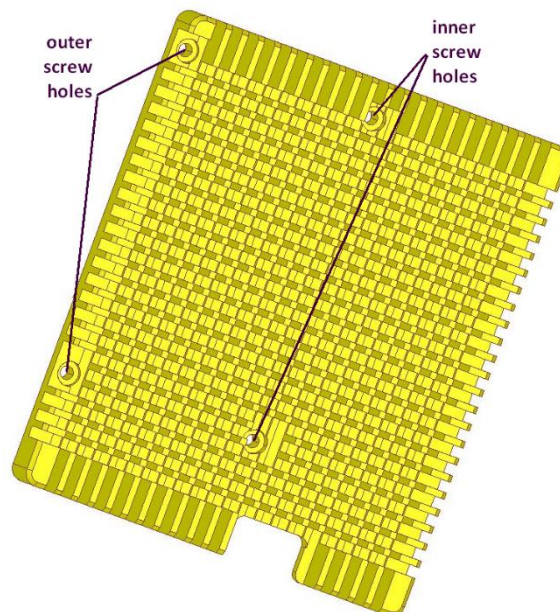


The thermal conduction between cooler and CPU is performed via a 1mm thick thermal pad. Make sure, that this thermal pad is placed over the CPU package before mounting the heatsink.

After the module has been pressed down, place the heatsink exactly over the mounting holes without scratching or touching any other parts on the PCB.



Insert the outer screws first and tighten them just a few turns. Then insert the two inner screws also with a few turns. Now check the gap between carrier and module for other parts than the CPU touching the heatsink. Check the thermal CPU pad for correct position. Tighten the four screws with no more than 30Ncm.



For the removal of the module, first unplug all connections to the system. Take off the inner screws, then the outer ones. The thermal pad may cause the heatsink sticking to the module, so take care, while pulling apart to avoid collisions with any part of the module. Lift the module to about 25° and remove it from the connector. Store the parts on a static free area.

6.2 DRAM

The module is fitted with two individual DDR3L memory blocks, each 32bits wide and with 1GByte capacity. The used parts are 4GBit devices organized in 256M x 16 bits with 15 row, 10 column and 3 bank addresses. The refresh rate depends on the operating temperature must be set according to the following table

Case Temperature	Refresh Cycle Time
T _c <85°C	7.8us
85°C<T _c <95°C	3.9us
95°C<T _c <105°C	1.95us

The DDR3L command bus is actively terminated and the routed in a fly by structure. The following table shows all trace lengths, in case write leveling should be adjusted. The used layer stack together with the FR4 material causes a signal run time of 6.8ps/mm.

DRAM	Signal Group	Trace Length		Description
Bank0	Command	J1->J2	54.0mm	CPU->DRAM
Bank0	Command	J2->J3	13.1mm	DRAM->DRAM
Bank0	Byte 0	J1->J2	25.7mm	CPU->DRAM
Bank0	Byte 1	J1->J2	22.7mm	CPU->DRAM
Bank0	Byte 2	J1->J3	23.1mm	CPU->DRAM
Bank0	Byte 3	J1->J3	18.3mm	CPU->DRAM
Bank1	Command	J1->J4	54.5mm	CPU->DRAM
Bank1	Command	J4->J5	13.9mm	DRAM->DRAM
Bank1	Byte 0	J1->J4	25.3mm	CPU->DRAM
Bank1	Byte 1	J1->J4	22.9mm	CPU->DRAM
Bank1	Byte 2	J1->J5	19.0mm	CPU->DRAM
Bank1	Byte 3	J1->J5	17.2mm	CPU->DRAM

6.3 eMMC

The local boot device of the MPX-S32V module is realized as an eMMC. The MTFC16GAKAENA-4M-IT from Micron uses the 8-bit wide data bus, provided by the μ SDHC module of the S32V234. This interface is shared between the external storage devices on the carrier board and the local eMMC. The selection can be either made by the setting of a CPU GPIO pin or via the MCU. Per default, the multiplexing is done through the MCU by the setting of the boot mode switch.

The reset input of the eMMC device is connected to port PTB7 of the MCU. In case this port is not configured, the FRSTI# signal is tied to +3.3V by a pullup resistor.

6.4 Leds

There are four LEDs onboard the MPX-S32V module. The user LEDs 1 and 2 can be controlled by two CPU GPIO pins, led 3 indicates state of the reset line and led 4 is connected to the MCU port PTC3.

Led	Color	ON	OFF	Description
LD1	green	CPU-PG5=high	CPU-PG5=low	LDG1 installed / LDG3 not installed
LD2	green	CPU-PG6=high	CPU-PG6=low	LDG2 installed / LDG4 not installed
LD1	green	CPU-PB1=high	CPU-PB1=low	LDG3 installed / LDG1 not installed
LD2	green	CPU-PB2=high	CPU-PB2=low	LDG4 installed / LDG2 not installed
LD3	red	RESET#=low	RESET#=high	Reset state indicator
LD4	yellow	MCU-PTC3=high	MCU-PTC3=low	MCU status led

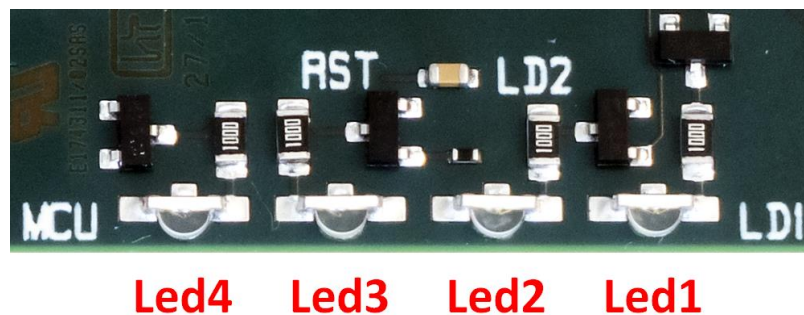


Figure 22: MPX-LEDs

6.5 Switches

The sliding switch GPU on the MPX-S32V module is used to disconnect the GPU power pins to reduce power consumption, in case the GPU is not used. The other sliding switch BMD is used to select between RCON controlled and serial boot mode. Both switches are located at the PCB edge on the bottom of the MPX-S32V module.

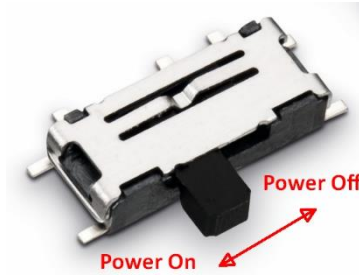


Figure 23: GPU switch



Figure 25: GPU Power On (default)



Figure 24: GPU Power Off



Figure 26: BMD Switch



Any handling of these switches must be done exclusively using nonconductive tools to avoid short circuits between carrier board and module.

6.6 Module Connector

The carrier board CRX-S32V provides a connector “MXM” which accepts only compatible CPU modules from the MicroSys MPX-S32V-family.

Manufacturer:	JAE
Type:	MM70-314-310-B1-1-R300
Used with:	MicroSys MPX-S32V module family

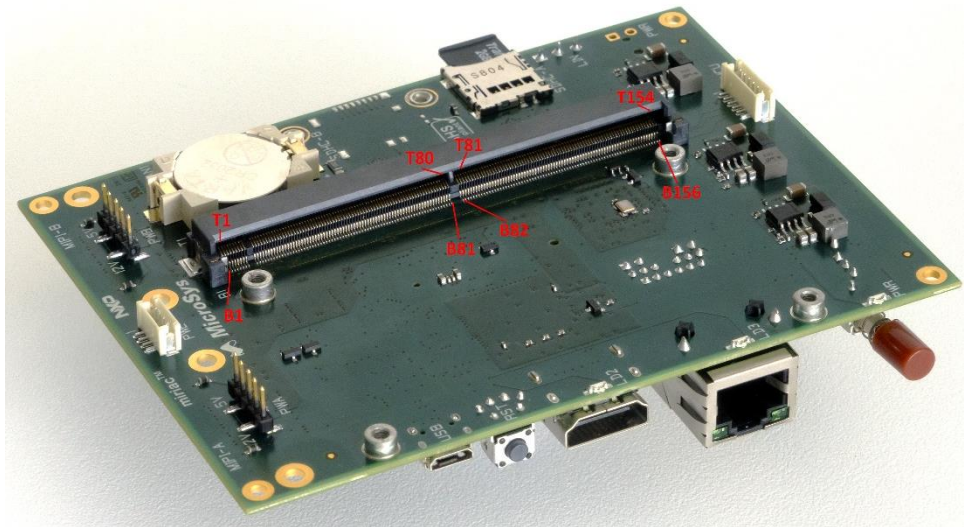


Figure 27: MXM-Connector

6.7 Module/Carrier Connections

MPX-S32V		IO	CRX-S32V	
Pin	Signal	Voltage	Pin	Signal
B1	IIC1-SDA	3.3V	B1	CSI1-SDA (MIPIB)
T1	GND		T1	GND
B2	GND		B2	GND
T2	CAN-FD0-TX	3.3V	T2	CAN-FD0-TX (CAN0)
B3	IIC1-SCL	3.3V	B3	CSI1-SCL (MIPIB)
T3	CAN-FD0-RX	3.3V	T3	CAN-FD0-RX (CAN0)
B4	JTAG-TCK	3.3V	B4	JTAG-TCK (JTAG)
T4	GND		T4	GND
B5	JTAG-TDI	3.3V	B5	JTAG-TDI (JTAG)
T5	CAN-FD1-TX	3.3V	T5	CAN-FD1-TX (CAN1)
B6	JTAG-TRST#	3.3V	B6	JTAG-TRST# (JTAG)
T6	CAN-FD1-RX	3.3V	T6	CAN-FD1-RX (CAN1)
B7	JTAG-TMS	3.3V	B7	JTAG-TMS (JTAG)
T7	GND		T7	GND
B8	GND		B8	GND
T8	CSI1-DT0+	1.0V	T8	CSI1-DT0+ (MIPIB)
B9	JTAG-TDO	3.3V	B9	JTAG-TDO (JTAG)
T9	CSI1-DT0-	1.0V	T9	CSI1-DT0- (MIPIB)
B10	FLXR-TENB	3.3V	B10	FLXR-TENB (CAN1)
T10	GND		T10	GND
B11	FLXR-TENA	3.3V	B11	FLXR-TENA (CAN0)
T11	CSI1-DT1-	1.0V	T11	CSI1-DT1- (MIPIB)
B12	FLXR-TXD	3.3V	B12	FLXR-TXD (LED2)
T12	CSI1-DT1+	1.0V	T12	CSI1-DT1+ (MIPIB)
B13	FLXR-RXD	3.3V	B13	FLXR-RXD (LED3)
T13	GND		T13	GND
B14	GND		B14	GND
T14	CSI1-DT2+	1.0V	T14	CSI1-DT2+ (MIPIB)
B15	3.3V rail output		B15	+3V3
T15	CSI1-DT2-	1.0V	T15	CSI1-DT2- (MIPIB)
B16	1.8V rail output		B16	+1V8
T16	GND		T16	GND
B17	GND		B17	GND
T17	CSI1-DT3-	1.0V	T17	CSI1-DT3- (MIPIB)
B18	CSI0-CLK+	1.0V	B18	CSI0-CLK+ (MIPIA)
T18	CSI1-DT3+	1.0V	T18	CSI1-DT3+ (MIPIB)
B19	CSI0-CLK-	1.0V	B19	CSI0-CLK- (MIPIA)
T19	GND		T19	GND
B20	GND		B20	GND

T20	CSI0-DT0+	1.0V	T20	CSI0-DT0+ (MIPIA)
B21	CSI1-CLK+	1.0V	B21	CSI1-CLK+ (MIPIB)
T21	CSI0-DT0-	1.0V	T21	CSI0-DT0- (MIPIA)
B22	CSI1-CLK-	1.0V	B22	CSI1-CLK- (MIPIB)
T22	GND		T22	GND
B23	GND		B23	GND
T23	CSI0-DT1-	1.0V	T23	CSI0-DT1- (MIPIA)
B24	CSI0-DT2+	1.0V	B24	CSI0-DT2+ (MIPIA)
T24	CSI0-DT1+	1.0V	T24	CSI0-DT1+ (MIPIA)
B25	CSI0-DT2-	1.0V	B25	CSI0-DT2- (MIPIA)
T25	GND		T25	GND
B26	CSI0-DT3-	1.0V	B26	CSI0-DT3- (MIPIA)
T26	VIU0-D17	3.3V/1.8V	T26	
B27	CSI0-DT3+	1.0V	B27	CSI0-DT3+ (MIPIA)
T27	VIU0-D18	3.3V/1.8V	T27	
B28	GND		B28	GND
T28	GND		T28	GND
B29	VIU0-D08	3.3V/1.8V	B29	
T29	VIU0-D19	3.3V/1.8V	T29	
B30	VIU0-D09	3.3V/1.8V	B30	
T30	VIU0-D20	3.3V/1.8V	T30	
B31	GND		B31	GND
T31	GND		T31	GND
B32	VIU0-D10	3.3V/1.8V	B32	
T32	VIU0-D21	3.3V/1.8V	T32	
B33	VIU0-D11	3.3V/1.8V	B33	
T33	VIU0-D22	3.3V/1.8V	T33	
B34	VIU0-D12	3.3V/1.8V	B34	
T34	GND		T34	GND
B35	VIU0-D13	3.3V/1.8V	B35	
T35	VIU0-D23	3.3V/1.8V	T35	
B36	GND		B36	GND
T36	VIU0-PCLK	3.3V/1.8V	T36	
B37	VIU0-D14	3.3V/1.8V	B37	
T37	GND		T37	GND
B38	VIU0-D15	3.3V/1.8V	B38	
T38	VIU0-VSYNC	3.3V/1.8V	T38	
B39	VIU0-D16	3.3V/1.8V	B39	
T39	VIU0-HSYNC	3.3V/1.8V	T39	
B40	VIU1-D08	3.3V/1.8V	B40	VIU1-D08 (SDHC-B)
T40	GND		T40	GND
B41	GND		B41	GND
T41	DCU-B0	1.8V	T41	DCU-B0 (HDMI)
B42	VIU1-D09	3.3V/1.8V	B42	VIU1-D09 (SDHC-B)
T42	DCU-B1	1.8V	T42	DCU-B1 (HDMI)
B43	VIU1-D10	3.3V/1.8V	B43	VIU1-D10 (SDHC-B)

T43	GND		T43	GND
B44	VIU1-D11	3.3V/1.8V	B44	VIU1-D11 (SDHC-B)
T44	DCU-B2	1.8V	T44	DCU-B2 (HDMI)
B45	VIU1-D12	3.3V/1.8V	B45	
T45	DCU-B3	1.8V	T45	DCU-B3 (HDMI)
B46	VIU1-D13	3.3V/1.8V	B46	
T46	GND		T46	GND
B47	VIU1-D14	3.3V/1.8V	B47	
T47	DCU-B4	1.8V	T47	DCU-B4 (HDMI)
B48	VIU1-D15	3.3V/1.8V	B48	
T48	DCU-B5	1.8V	T48	DCU-B5 (HDMI)
B49	VIU1-D16	3.3V/1.8V	B49	
T49	GND		T49	GND
B50	GND		B50	GND
T50	DCU-B6	1.8V	T50	DCU-B6 (HDMI)
B51	VIU1-D17	3.3V/1.8V	B51	
T51	DCU-B7	1.8V	T51	DCU-B7 (HDMI)
B52	VIU1-D18	3.3V/1.8V	B52	
T52	GND		T52	GND
B53	VIU1-D19	3.3V/1.8V	B53	
T53	DCU-DE	1.8V	T53	DCU-DE (HDMI)
B54	VIU1-D20	3.3V/1.8V	B54	
T54	DCU-PCLK	1.8V	T54	DCU-PCLK (HDMI)
B55	GND		B55	GND
T55	GND		T55	GND
B56	VIU1-D21	3.3V/1.8V	B56	
T56	DCU-HSYNC	1.8V	T56	DCU-HSYNC (HDMI)
B57	VIU1-D22	3.3V/1.8V	B57	
T57	DCU-VSYNC	1.8V	T57	DCU-VSYNC (HDMI)
B58	VIU1-D23	3.3V/1.8V	B58	
T58	GND		T58	GND
B59	VIU1-PCLK	3.3V/1.8V	B59	VIU1-PCLK (SDHC-B)
T59	DCU-TAG	1.8V	T59	DCU-TAG (HDMI-EN)
B60	VIU1-HSYNC	3.3V/1.8V	B60	VIU1-HSYNC (SDHC-B)
T60	DCU-G0	1.8V	T60	DCU-G0 (HDMI)
B61	VIU1-VSYNC	3.3V/1.8V	B61	VIU1-VSYNC (SDHC-B)
T61	GND		T61	GND
B62	DCU-R0	1.8V	B62	DCU-R0 (HDMI)
T62	DCU-G1	1.8V	T62	DCU-G1 (HDMI)
B63	DCU-R1	1.8V	B63	DCU-R1 (HDMI)
T63	DCU-G2	1.8V	T63	DCU-G2 (HDMI)
B64	DCU-R2	1.8V	B64	DCU-R2 (HDMI)
T64	GND		T64	GND
B65	DCU-R3	1.8V	B65	DCU-R3 (HDMI)
T65	DCU-G3	1.8V	T65	DCU-G3 (HDMI)
B66	DCU-R4	1.8V	B66	DCU-R4 (HDMI)

T66	DCU-G4	1.8V	T66	DCU-G4 (HDMI)
B67	DCU-R5	1.8V	B67	DCU-R5 (HDMI)
T67	GND		T67	GND
B68	GND		B68	GND
T68	DCU-G5	1.8V	T68	DCU-G5 (HDMI)
B69	DCU-R6	1.8V	B69	DCU-R6 (HDMI)
T69	DCU-G6	1.8V	T69	DCU-G6 (HDMI)
B70	DCU-R7	1.8V	B70	DCU-R7 (HDMI)
T70	GND		T70	GND
B71	SDHC-D7	3.3V	B71	
T71	DCU-G7	1.8V	T71	DCU-G7 (HDMI)
B72	SDHC-D6	3.3V	B72	
T72			T72	
B73	GND		B73	GND
T73	GND		T73	GND
B74	SDHC-D5	3.3V	B74	
T74	SDHC-D4	3.3V	T74	
B75	SDHC-CMD	3.3V	B75	SDHC-CMD (SDHC-A)
T75	SDHC-D3	3.3V	T75	SDHC-D3 (SDHC-A)
B76	GND		B76	GND
T76	GND		T76	GND
B77	SDHC-CLK	3.3V	B77	SDHC-CLK (SDHC-A)
T77	SDHC-D2	3.3V	T77	SDHC-D2 (SDHC-A)
B78	SDHC-WP	3.3V	B78	SDHC-WP (SDHC-A)
T78	SDHC-D1	3.3V	T78	SDHC-D1 (SDHC-A)
B79	GND		B79	GND
T79	GND		T79	GND
B80	SDHC-RST	3.3V	B80	
T80	SDHC-D0	3.3V	T80	SDHC-D0 (SDHC-A)
B81	SDHC-VSEL	3.3V	B81	
T81	GND		T81	GND
B82	GND		B82	GND
T82	PCIE-TX-	1.0V	T82	PCIE-TX- (mPCIe)
B83	UART1-TXD	1.8V	B83	UART1-TXD (LIN)
T83	PCIE-TX+	1.0V	T83	PCIE-TX+ (mPCIe)
B84	UART1-RXD	1.8V	B84	UART1-RXD (LIN)
T84	GND		T84	GND
B85	GND		B85	GND
T85	PCIE-RX-	1.0V	T85	PCIE-RX- (mPCIe)
B86	UART0-TXD	3.3V	B86	UART0-TXD (USB)
T86	PCIE-RX+	1.0V	T86	PCIE-RX+ (mPCIe)
B87	UART0-RXD	3.3V	B87	UART0-RXD (USB)
T87	GND		T87	GND
B88	GND		B88	GND
T88	PCIE-CLK+	1.0V	T88	PCIE-CLK+ (mPCIe)
B89	I2C2-SDA	1.8V	B89	I2C2-SDA (mPCIe,HDMI)

T89	PCIE-CLK-	1.0V	T89	PCIE-CLK- (mPCIe)
B90	I2C2-SCL	1.8V	B90	I2C2-SCL (mPCIe,HDMI)
T90	GND		T90	GND
B91	SPI3-CS0#	1.8V	B91	
T91	LFAST-TX-	1.6V	T91	
B92	SPI3-SCK	1.8V	B92	
T92	LFAST-TX+	1.6V	T92	
B93	SPI3-SIN	1.8V	B93	
T93	GND		T93	GND
B94	SPI3-SOUT	1.8V	B94	
T94	LFAST-RX-	1.6V	T94	
B95	SPI0-CS0#	1.8V	B95	
T95	LFAST-RX+	1.6V	T95	
B96	SPI0-SCK	1.8V	B96	
T96	GND		T96	GND
B97	SPI0-SIN	1.8V	B97	
T97	EMI-MDC	1.8V	T97	EMI-MDC (LAN)
B98	SPI0-SOUT	1.8V	B98	
T98	EMI-MDIO	1.8V	T98	EMI-MDIO (LAN)
B99	SPI1-SIN	1.8V	B99	CSIO-SYN (MIPIA)
T99	GND		T99	GND
B100	SPI1-SOUT	1.8V	B100	CSI1-SYN (MIPIB)
T100	EC-COL	1.8V	T100	EC-COL (LAN)
B101	GND		B101	GND
T101	EC-TXCK	1.8V	T101	EC-TXCK (LAN)
B102	SPI1-SCK	1.8V	B102	
T102	GND		T102	GND
B103	SPI1-CS0#	1.8V	B103	
T103	EC-TXD3	1.8V	T103	EC-TXD3 (LAN)
B104	FXT0-CH0	1.8V	B104	
T104	EC-RXDV	1.8V	T104	EC-RXDV (LAN)
B105	FXT0-CH1	1.8V	B105	CSIO-RST# (MIPIA)
T105	GND		T105	GND
B106	FXT0-CH2	1.8V	B106	
T106	EC-RXD1	1.8V	T106	EC-RXD1 (LAN)
B107	GND		B107	GND
T107	EC-TXD2	1.8V	T107	EC-TXD2 (LAN)
B108	FXT0-CH3	1.8V	B108	
T108	GND		T108	GND
B109	FXT1-CH0	1.8V	B109	FXT1-CH0 (MIPIA/B)
T109	EC-RXD0	1.8V	T109	EC-RXD0 (LAN)
B110	FXT1-CH1	1.8V	B110	FXT1-CH1 (MIPIA/B)
T110	EC-CRS	1.8V	T110	EC-CRS (LAN)
B111	SPI2-SOUT	1.8V	B111	
T111	GND		T111	GND
B112	GND		B112	GND

T112	EC-RXER	1.8V	T112	
B113	SPI2-SCK	1.8V	B113	
T113	EC-TXER	1.8V	T113	
B114	SPI2-SIN	1.8V	B114	CSI1-RST# (MIPIB)
T114	GND		T114	GND
B115	GND		B115	GND
T115	EC-RXD3	1.8V	T115	EC-RXD3 (LAN)
B116	SPI2-CS0#	1.8V	B116	
T116	EC-TXEN	1.8V	T116	EC-TXEN (LAN)
B117	ENET-T0	1.8V	B117	CSI0-SDA (MIPIA)
T117	GND		T117	GND
B118	ENET-T1	1.8V	B118	CSI0-SCL (MIPIA)
T118	EC-RXD2	1.8V	T118	EC-RXD2 (LAN)
B119	ENET-T2	3.3V	B119	
T119	EC-TXD0	1.8V	T119	EC-TXD0 (LAN)
B120	TRACE-D00	1.8V	B120	
T120	GND		T120	GND
B121	TRACE-D02	1.8V	B121	
T121	EC-RXCK	1.8V	T121	EC-RXCK (LAN)
B122	TRACE-D04	1.8V	B122	
T122	EC-TXD1	1.8V	T122	EC-TXD1 (LAN)
B123	TRACE-D06	1.8V	B123	
T123	GND		T123	GND
B124	GND		B124	GND
T124	TRACE-CLK	1.8V	T124	
B125	TRACE-D08	1.8V	B125	
T125	TRACE-D01	1.8V	T125	
B126	TRACE-D10	1.8V	B126	
T126	GND		T126	GND
B127	TRACE-D12	1.8V	B127	
T127	TRACE-D03	1.8V	T127	
B128	TRACE-D14	1.8V	B128	
T128	TRACE-D05	1.8V	T128	
B129	GND		B129	GND
T129	GND		T129	GND
B130	BOOT-SEL1	3.3V	B130	BOOT-SEL1 (MCU)
T130	TRACE-D07	1.8V	T130	
B131	BOOT-SEL2	3.3V	B131	BOOT-SEL2 (MCU)
T131	TRACE-D09	1.8V	T131	
B132	RSTIN#	3.3V	B132	RSTIN# (MCU)
T132	GND		T132	GND
B133	VRTC	3.3V	B133	VRTC (RTC)
T133	TRACE-D11	1.8V	T133	
B134	GND		B134	GND
T134	TRACE-D13	1.8V	T134	
B135	I2C0-SCL	3.3V	B135	

T135	TRACE-D15	1.8V	T135	
B136	I2C0-SDA	3.3V	B136	
T136	RSTOUT#	3.3V	T136	RSTOUT# (MCU)
B137	MCU-DIO	3.3V	B137	MCU-DIO (MCU)
T137	GND		T137	GND
B138	MCU-CLK	3.3V	B138	MCU-CLK (MCU)
T138	GND		T138	GND
B139	GND		B139	GND
T139	GND		T139	GND
B140	GND		B140	GND
T140	GND		T140	GND
B141	GND		B141	GND
T141	GND		T141	GND
B142	GND		B142	GND
T142	GND		T142	GND
B143	GND		B143	GND
T143	GND		T143	GND
B144	GND		B144	GND
T144	GND		T144	GND
B145	GND		B145	GND
T145	GND		T145	GND
B146	GND		B146	GND
T146	+VIN		T146	+12V
B147	GND		B147	GND
T147	+VIN		T147	+12V
B148	+VIN		B148	+12V
T148	+VIN		T148	+12V
B149	+VIN		B149	+12V
T149	+VIN		T149	+12V
B150	+VIN		B150	+12V
T150	+VIN		T150	+12V
B151	+VIN		B151	+12V
T151	+VIN		T151	+12V
B152	+VIN		B152	+12V
T152	+VIN		T152	+12V
B153	+VIN		B153	+12V
T153	+VIN		T153	+12V
B154	+VIN		B154	+12V
T154	+VIN		T154	+12V
B155	+VIN		B155	+12V
B156	+VIN		B156	+12V

Table 4: MXM Connector

7 JTAG Chain

7.1.1 JTAG Devices

The JTAG chain of the SBC-S32V includes the S32V234 processor only. The JTAG port is directly connected to the connector “JTAG”.

7.1.2 JTAG Connector

The JTAG connector provides all standard JTAG signals for an ARM interface on a 2x5 pin header. Pin 7 of this header usually connects the return clock RTCK and is not used on the CRX-S32V. For boundary scan purposes, it can be used to control the TRST# signal. As this feature is not standard due to the 10 pin ARM interface, it can be disconnected by the header JRS. The header JRS is located directly behind the reset push button.

Manufacturer:	SAMTEC
Type:	2x5 Pin Header, 1.27mm Pitch
Mates with:	SAMTEC FFSD-05-01-N

Table 5 JTAG Header

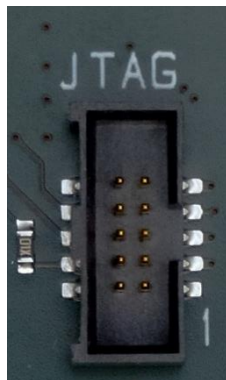


Figure 28: JTAG Connector



Figure 29: TRST Connect



7.1.3 JTAG Connector Pinout

JTAG		S32V234		I/O Level	Description		
Pin	Signal	Pin	Name		Direction	Function	Termination
1	+3,3V				Output	Reference voltage	
2	TMS	→ D9	TMS	LVTTTL	Input	Test mode select	4k7 pullup to +3,3V
3	GND			LVTTTL		Ground	
4	TCK	→ B9	TCK	LVTTTL	Input	Clock	4k7 pullup to +3,3V
5	GND			LVTTTL		Ground	
6	TDO	← E10	TDO	LVTTTL	Output	Data out	4k7 pullup to +3,3V
7	Option	→ C9	TRST#	LVTTTL	Input	Test Reset	4k7 pullup to +3,3V
8	TDI	→ A18	TDI	LVTTTL	Input	Data in	4k7 pullup to +3,3V
9	GND			LVTTTL		Ground	
10	RSTIN#	→		LVTTTL	Input	System Reset	4k7 pullup to +3,3V

8 I²C Structure

The SBC-S32V operates on three different I²C busses.

I²C Bus 0 is only connected to the MIPI-CSI port A, while I²C Bus 1 covers the MIPI-CSI port B.

I²C Bus 2 controls all other devices on the module and carrier as well as the miniPCIe slot and the HDMI connected devices.

Due to the unpredictable access address of HDMI and miniPCIe slot devices, care must be taken to avoid double addressing with the other I²C devices on this bus.

8.1.1 Bus Map

I²C Bus 0:

Address	Reference	Device	Function
0x00-0x7F	---	MIPIA	External devices

Table 6 I²C0 bus map

I²C Bus 1:

Address	Reference	Device	Function
0x00-0x7F	---	MIPIB	External devices

Table 7 I²C1 bus map

I²C Bus 2:

Address	Reference	Device	Function
0x51	J25 [module]	PCF85263A	Real Time Clock
0x3F	J6 [carrier]	TFP410P	HDMI Transmitter
0x00-0x7F	HDMI-A [carrier]	HDMI Connector	DDC
0x00-0x7F	PCIE-A [carrier]	miniPCIe Slot	External devices

Table 8 I²C2 bus map

8.1.2 I²C Devices

8.1.2.1 RTC

The RTC PCF85263A provides year, month, day, weekday, hours, minutes, seconds and 100th seconds. It can be protected against data loss by the backup batterie located on the CRX-S32V carrier.

It is accessible via I²C Bus 2 at the 7bit address 0x51. It offers a time stamp input and an interrupt output, which are both connected to the MCU.

8.1.2.2 RTC Backup Battery

The battery holder is designed for CR2032 batteries. The battery type should have a nominal voltage of 3.0V. The backup battery is necessary to keep time and date of the real-time clock on the MPX-S32V module.

Manufacturer:	Würth
Type:	79527141
Used with:	CR2032 batteries, 3V



Figure 30: Battery Holder & Battery

8.1.3 Digital Visual Interface

The CRX-S32V uses a TFP410PAP as a digital display driver for its HDMI interface. The device is accessible via I²C bus 2 at the 7bit address 0x3F. The HDMI port contains a DDC interface which is also connected to the I²C bus 2. This DDC interface is disabled after RESET and must be enabled by a low output state of the CPU port PH11, i.e. GPIO[123] or DCU_TAG. Care must be taken due to the fact, that access addresses of unknown external devices may collide with other devices located on the I²C bus 2

9 Peripherals

9.1 HDMI

The video output of the SBC-S32V is realized with a TFP410 DVI/HDMI interface.

It can be used with a standard type A plug and supports DDC via the I²C bus 2. The DDC function can be enabled or disabled via the state of port pin PH11 of the S32V234. Therefore the port PH11 must be configured as general-purpose output.

The hot plug detect feature of the HDMI interface is supported by the TFP410 transmitter through its I²C CTL_2_MODE register. The TFP410 responds on the I²C bus 2 at the address 0x3F.

The CEC feature on pin 13 of the HDMI connector is not supported.



Care must be taken to avoid collisions with other I²C devices on bus 2!

9.1.1 DDC Function

PH11/GPIO[123]/DCU-TAG	Pin State	Function
Output	low	DDC enabled
Output	high	DDC disabled
Input	high	DDC disabled
Reset	high	DDC disabled

Table 9 DDC Function

9.1.2 HDMI Connector

Manufacturer:	Würth Elektronik
Type:	685119134923
Mates with:	HDMI Type A

Figure 31: HDMI Type A



Pin	Signal	Description
1	TMDS D2+	Data Pair 2
2	TMDS Shield	Data Pair 2 Shield
3	TMDS D2-	Data Pair 2
4	TMDS D1+	Data Pair 1
5	TMDS Shield	Data Pair 1 Shield
6	TMDS D1-	Data Pair 1
7	TMDS D0+	Data Pair 0
8	TMDS Shield	Data Pair 0 Shield
9	TMDS D0-	Data Pair 0
10	TMDS Clock+	Clock Pair
11	TMDS Shield	Clock Pair Shield
12	TMDS Clock-	Clock Pair
13	CEC	not connected
14	reserved.	not connected
15	DDC-SCL	Display Data Channel Clock
16	DDC-SDA	Display Data Channel Data
17	GND	Reference Ground
18	+5V	Supply for external DDC
19	HPLG	Hot Plug Detect

9.2 LAN Connection

The SBC-S32V system contains a Gigabit LAN interface with 10/100/1000BaseT capability based on the KSZ9031RNX netphy. It works with a RGMII connection and responds on the management address 0x01. The LAN jack contains two LEDs to indicated the actual link and transmit status.

The following picture shows the front view of the connector and its LEDs.

Manufacturer:	Würth Elektronik
Type:	749 911 1221A
Mates with:	RJ45 patch cable, category depending on speed

Figure 32: LAN-Jack



Led	Activity
Led1	Transmit / Receive
Led2	Link

9.3 PCIe Interface

The SBC-S32V system offers a single lanes x1 miniPCIe slot. The slot is supplied with +3.3V and +1.5V. Additional voltages, like +5.0V or +12V, are accessible by the power connector PWE1 located between power switch and LAN connector. The power rating for this connector is max.1A per pin.

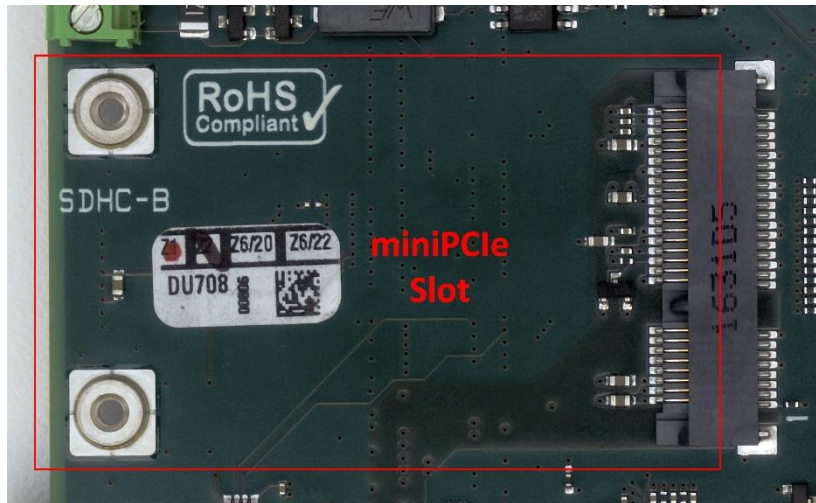


Figure 33: miniPCIe Slot

9.3.1 Power Connector PWE1

Manufacturer:	Würth
Type:	679304124022
mates with:	648004113322

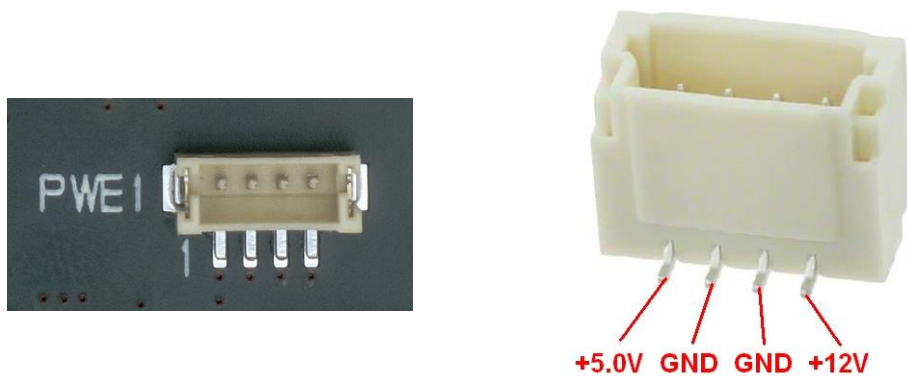


Figure 35: Power Connector PWE1

9.3.2 The Mini-PCIe Slot

Manufacturer:	Tyco
Type:	2041119-1
Used with:	Full size mini PCIe cards

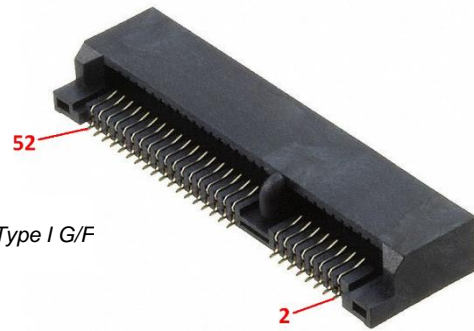


Figure 36: mini PCI-E 4H Type I G/F

Pin:			Pin:
1	WAKE#	+3.3V	2
3	COEX1	GND	4
5	COEX2	+1.5V	6
7	CLKREQ#	UIM-PWR	8
9	GND	UIM-DAT	10
11	REFCLK-	UIM-CLK	12
13	REFCLK+	UIM-RST	14
15	GND	UIM-VPP	16
MECHANICAL KEY			
17	Reserved	GND	18
19	Reserved	WDIS#	20
21	GND	PERST#	22
23	PER0+	+3.3V	24
25	PER0-	GND	26
27	GND	+1.5V	28
29	GND	I ² C-SCL	30
31	PET0+	I ² C-DAT	32
33	PET0-	GND	34
35	GND	USB-D-	36
37	GND	USB-D+	38
39	+3.3V	GND	40
41	+3.3V	LED-WWAN#	42
43	GND	LED_WLAN#	44
45	Reserved	LED_WPAN#	46
47	Reserved	+1.5V	48
49	Reserved	GND	50
51	Reserved	+3.3V	52

Table 10 miniPCIe Slot pinout

9.4 MIPI CSI Interface

The SBC-S32V offers two serial camera interfaces via the connectors MIPIA and MIPIB (Samtec QSE-020-01-F-D). Each connector contains a four-lane physical layer, compliant with the MIPI Alliance Standard and a clock lane. It also supports multiple cameras using Maxim deserializers.

Both interfaces are supplied with 5.0V and can be configured also for a 12V supply via the two headers PWA and PWB. For more information about the power setting for MIPIA and MIPIB please refer to **4.15.7 MIPI Power**.



Only a single link per header must be set at a time. More than one link installed may cause permanent damage to the board!

MIPIA is controlled by I²C Bus 0 while MIPIB is handled by I²C Bus 1.

Each slot can be controlled by several digital IO lines according to following diagram.

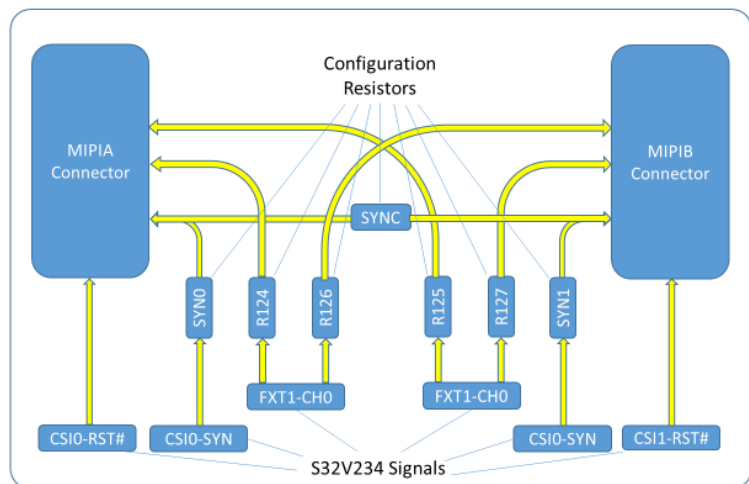
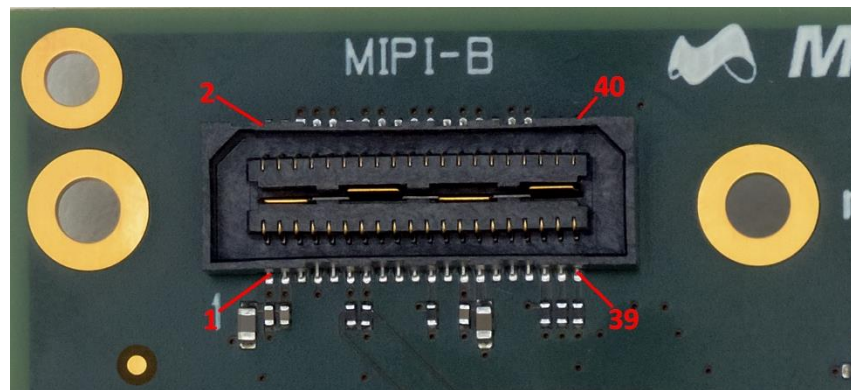
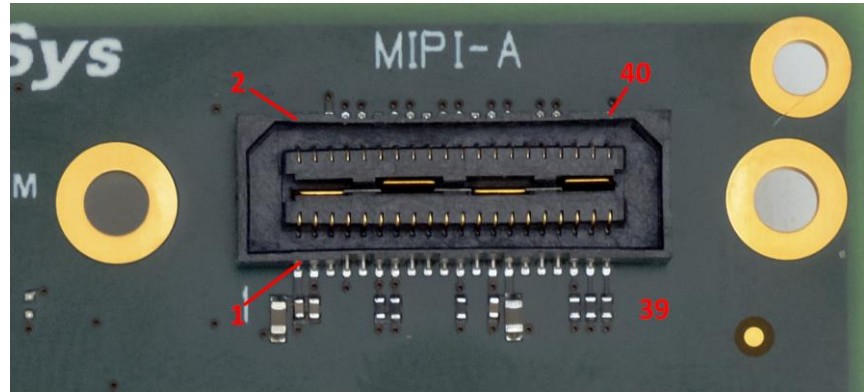


Figure 37: MIPI Configuration

9.4.1 MIPI Connectors

Manufacturer:	Samtec
Type:	QSE-020-01-F-D
mates with:	QTE-020-01-F-D



9.4.2 MIPIA Connector

MIPIA		IO	Description	S32V234
Pin	Signal	Voltage		Port
1	+5.0V		Supply	
2	n.c.			
3	+5.0V		Supply	
4	n.c.			
5	GND		Reference Ground	
6	GND		Reference Ground	
7	CSIO-CLK	1.0V	27MHz Clock	
8	CSIO-DT2+	1.0V	MIPI Lane 2	
9	GND		Reference Ground	
10	CSIO-DT2-	1.0V	MIPI Lane 2	
11	CSIO-SDA	1.8V	I ² C Bus 0	PG3
12	GND		Reference Ground	
13	CSIO-SCL	1.8V	I ² C Bus 0	PG4
14	CSIO-DT0+	1.0V	MIPI Lane 0	
15	n.c.			
16	CSIO-DT0-	1.0V	MIPI Lane 0	
17	n.c.			
18	GND		Reference Ground	
19	n.c.			
20	CSIO-CLK+	1.0V	MIPI Clock	
21	CSIO-RST#	1.8V	Reset Line	PC6
22	CSIO-CLK-	1.0V	MIPI Clock	
23	GND		Reference Ground	
24	GND		Reference Ground	
25	+5V/+12V		Supply via PWA	
26	CSIO-DT1+	1.0V	MIPI Lane 1	
27	+5V/+12V		Supply via PWA	
28	CSIO-DT1-	1.0V	MIPI Lane 1	
29	GND		Reference Ground	
30	GND		Reference Ground	
31	n.c.			
32	CSIO-DT3+	1.0V	MIPI Lane 3	
33	n.c.			
34	CSIO-DT3-	1.0V	MIPI Lane 3	
35	CSIO-SYN	1.8V	Sync Line	PB10
36	n.c.			
37	FXT1-CH0	1.8V	t.b.d.	PC9
38	n.c.			
39	FXT1-CH1	1.8V	t.b.d.	PC10
40	n.c.			

9.4.3 MIPIB Connector

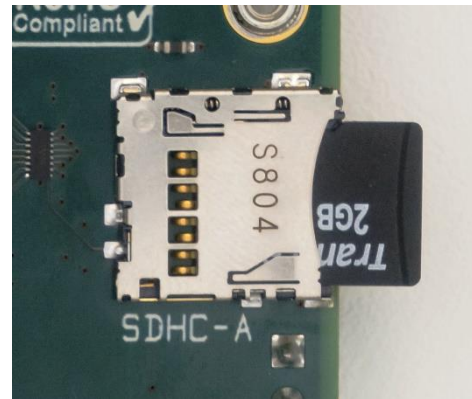
MIPIB		IO	Description	S32V234
Pin	Signal	Voltage		Port
1	+5.0V		Supply	
2	n.c.			
3	+5.0V		Supply	
4	n.c.			
5	GND		Reference Ground	
6	GND		Reference Ground	
7	CSI1-CLK	1.0V	27MHz Clock	
8	CSI1-DT2+	1.0V	MIPI Lane 2	
9	GND		Reference Ground	
10	CSI1-DT2-	1.0V	MIPI Lane 2	
11	CSI1-SDA	1.8V	I ² C Bus 1	PG5
12	GND		Reference Ground	
13	CSI1-SCL	1.8V	I ² C Bus 1	PG6
14	CSI1-DT0+	1.0V	MIPI Lane 0	
15	n.c.			
16	CSI1-DT0-	1.0V	MIPI Lane 0	
17	n.c.			
18	GND		Reference Ground	
19	n.c.			
20	CSI1-CLK+	1.0V	MIPI Clock	
21	CSI1-RST#	1.8V	Reset Line	PB15
22	CSI1-CLK-	1.0V	MIPI Clock	
23	GND		Reference Ground	
24	GND		Reference Ground	
25	+5V/+12V		Supply via PWB	
26	CSI1-DT1+	1.0V	MIPI Lane 1	
27	+5V/+12V		Supply via PWB	
28	CSI1-DT1-	1.0V	MIPI Lane 1	
29	GND		Reference Ground	
30	GND		Reference Ground	
31	n.c.			
32	CSI1-DT3+	1.0V	MIPI Lane 3	
33	n.c.			
34	CSI1-DT3-	1.0V	MIPI Lane 3	
35	CSI1-SYN	1.8V	Sync Line	PB11
36	n.c.			
37	FXT1-CH0	1.8V	t.b.d.	PC9
38	n.c.			
39	FXT1-CH1	1.8V	t.b.d.	PC10
40	n.c.			

9.5 MicroSD Card Slot

The SBC-S32V system offers two microSD Card interfaces. The microSD card A can also be configured as a boot device. Both SD cards work with 3.3V operation voltage. SD card slot B is a mounting option and not installed in the standard version.

Manufacturer:	Yamaichi
Type:	PJS-008-2130-0
Used with:	microSD cards

Figure 38: micro SD-Card A



microSD card slot A interconnection:

I/O Range	SDHCA			S32V234		
	Pin	Name		Pin	Signal	Port
LVTTTL	1	DAT2	↔	V21	SD_DAT2	PK10
LVTTTL	2	CD/DAT3	↔	V22	SD_DAT3	PK11
LVTTTL	3	CMD	←	U22	SD_CMD	PK7
	4	Vdd				
LVTTTL	5	CLK	←	V25	SD_CLK	PK6
	6	Vss				
LVTTTL	7	DAT0	↔	V23	SD_DAT0	PK8
LVTTTL	8	DAT1	↔	U23	SD_DAT1	PK9
LVTTTL	9	SW1	→	U25	SD_WP	PK5

Table 11 microSD card slot pin assignment

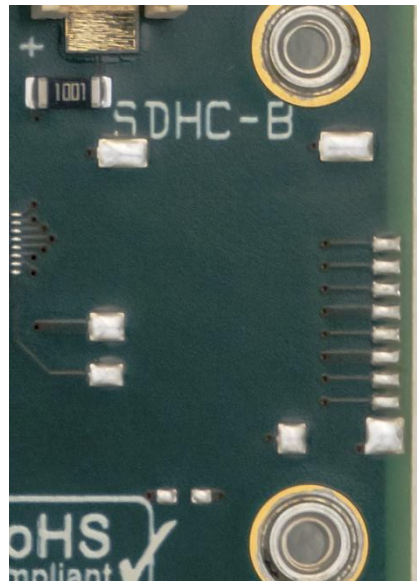


Figure 39: not fitted SDHC-B connector

microSD card slot B interconnection:

I/O Range	SDHCA			S32V234		
	Pin	Name		Pin	Signal	Port
LVTTTL	1	DAT2	↔	N20	SD_DAT2	PF5
LVTTTL	2	CD/DAT3	↔	N25	SD_DAT3	PF6
LVTTTL	3	CMD	←	P22	SD_CMD	PF2
	4	Vdd				
LVTTTL	5	CLK	←	P21	SD_CLK	PF1
	6	Vss				
LVTTTL	7	DAT0	↔	M20	SD_DAT0	PF3
LVTTTL	8	DAT1	↔	N23	SD_DAT1	PF4
LVTTTL	9	SW1	→	P23	SD_WP	PF0

Table 12 microSD card slot pin assignment

9.6 UART

The SBC-S32V system is provided with two serial UART interfaces.

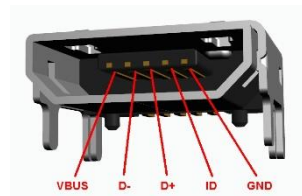
UART1 is converted to USB 2.0 for easy console port connection with a PC.

UART2 is converted to the LIN 2.1 standard and available on a three-terminal wire connector.

9.6.1 UART1

Manufacturer:	Würth Elektronik
Type:	629 105 150 521
Mates with:	Standard Micro USB plug

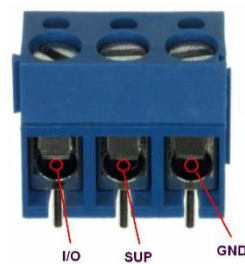
Figure 40 micro USB



9.6.2 UART2

Manufacturer:	Würth Elektronik
Type:	691 214 110 003
Mates with:	0.2-1.5mm ² wire

Figure 41 LIN Connector



9.7 CAN

The SBC-S32V system offers two CAN-FD interfaces. CAN0 and CAN1 are accessible via two 2-terminal wire connectors. The necessary 120 ohms end-point termination can be activated by two dip switches

9.7.1 CAN0

Manufacturer:	Würth Elektronik
Type:	691 214 110 002
Mates with:	0.2-1.5mm ² wire

Figure 42: CAN0 Terminal Block



9.7.2 CAN1

Manufacturer:	Würth Elektronik
Type:	691 214 110 002
Mates with:	0.2-1.5mm ² wire

Figure 43: CAN1 Terminal Block

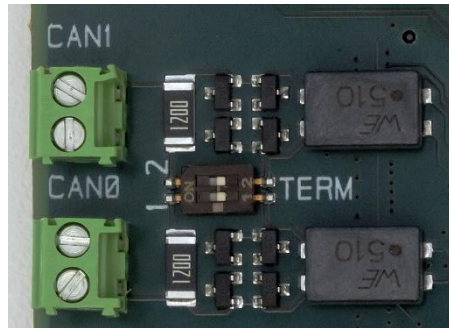


9.7.3 Termination

The termination is located in the middle behind the terminal blocks. It is activated if the according dip switch is set to ON.

Manufacturer:	Würth Elektronik
Type:	416131160802

Figure 44: CAN Termination Switch



Setting	TERM-1	TERM-2	CAN0	CAN1
	OFF	OFF	no termination	no termination
	ON	OFF	120R termination	no termination
	OFF	ON	no termination	120R termination
	ON	ON	120R termination	120R termination

9.8 LEDs

The CRX-S32V carrier contains 5 LEDs. There is one power led, two user LEDs and two ethernet traffic indicators. The green power led located underneath the power switch indicates the supply of +12V. The yellow user led, located under the HDMI connector, is connected to the CPU port PA8 and the red user led directly under the LAN jack uses CPU port PA9. The ethernet LEDs are integrated into the RJ45 jack and indicate link status and traffic.



Figure 45: Carrier LEDs

Led	Color	ON	OFF	Description
LD1	green	Power Switch On	Power Switch Off	+12V applied
LD2	yellow	CPU-PA8=high	CPU-PA8=low	Uses FLXR-TXD signal
LD3	red	CPU-PA9=high	CPU-PA9=low	Uses FLXR-RXD signal
LAN-B	yellow	Receive / Transmit	no traffic	KSZ9031 LED1 Control
LAN-C	yellow	Link active	no link	KSZ9031 LED2 Control

9.9 Switches

The SBC-S32V contains five switches, three of them are located on the carrier and two on the module. The main power switch PWR, the boot mode switches BOOT and BMD, the CAN termination switch TERM and the GPU power enable switch.

The power switch is an alternate action pushbutton switch to enable or disable power on all power rails for the whole system. For more information refer to **4.15.3 Input Power Switch**.



The boot mode switch is used to select between 4 possible boot configurations, implemented in the MCU. For more information refer to **5.3 Boot Mode Switch** and **5.2 Power Up Configuration**



The CAN termination switch is used to enable or disable a 120R termination resistor for each CAN line. For more information refer to **9.7.3 Termination**



The GPU power enable switch is used to reduce power consumption, in case the GPU is not used. For more information refer to chapter **6.5 Switches**



9.10 Jumpers

There are three jumper blocks onboard the SBC-S32V.

Two 5 pin headers for MIPI power selection

Figure 46: MIPI-A Power Selection

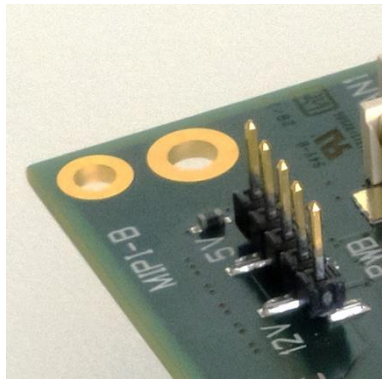
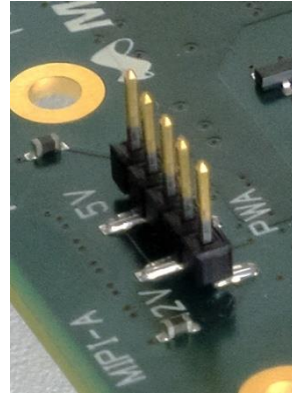


Figure 47: MIPI-B Power Selection



Anyway, only a single link per header must be set at a time. More than one link installed may cause permanent damage to the board!

One 2 pin header for the JTAG configuration

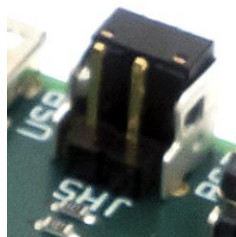


Figure 48: JRS Link

10 Appendix

10.1 Acronyms

These acronyms are being used within the document; note that this list does not claim to be complete or exhaustive:

ADAS.....	Advanced Driver Assistance Systems
ARM.....	Advanced RISC Machine
BaseT.....	Ethernet over twisted pair technologies
BIST.....	Built In Self-Test
CAN-FD.....	Controller Area Network with flexible Data rate
CEC.....	Consumer Electronics Control
Cortex-M4.....	ARMv7E-M architecture
CPU.....	Central Processing Unit
CR2032.....	IEC standard button cell
CSI.....	Camera Serial Interface
DDC.....	Display Data Channel
eMMC.....	embedded Multimedia Card
ESD.....	Electrostatic Discharge
FR4.....	flame retardant 4
GND.....	Ground
GPIO.....	General Purpose IO
GPL.....	General Public License
GPU.....	Graphic Processing Unit
HDMI.....	High-Definition Multimedia Interface
I ² C.....	Inter-Integrated Circuit
JTAG.....	Joint Test Action Group
Kinetis.....	ARM® Cortex-M0+ core
LAN.....	Local Area Network
LED.....	Light Emitting Diode
LIN.....	Local Interconnect Network
MCU.....	Microcontroller Unit
MIPI.....	Mobile Industry Processor Interface
MPX.....	MicroSys miriac Module
MXM.....	Mobile PCI Express Module
POL.....	Point Of Load
PPTC.....	Polymeric Positive Temperature Coefficient
RCON.....	Reset Configuration
RJ45.....	Registered Jack 45
RTC.....	Real Time Clock
SBC.....	Single Board Computer
SOM.....	System On Module
TFTP.....	Trivial File Transfer Protocol
TVS.....	Transient Voltage Suppressor
UART.....	Universal Asynchronous Receiver Transmitter
U-Boot.....	The Universal Boot Loader
USB.....	Universal Serial Bus

10.2 Table of Figures

Figure 1 Boot Switch	10
Figure 2: BMD Switch	10
Figure 3: GPU Switch.....	10
Figure 4 USB Connector	10
Figure 5 Power Switch Off.....	11
Figure 6 Power Jack	11
Figure 7 Power Switch ON.....	11
Figure 8 Mechanical Dimensions	17
Figure 9: Module Side connectors (carrier CRX-S32V).....	19
Figure 10 Non-Module Side connectors (carrier CRX-S32V).....	20
Figure 11:PN12SHSA03QE	27
Figure 12: G003-Series.....	27
Figure 13 Power supply structure.....	28
Figure 14: Connector PWE1 & PWE2.....	29
Figure 15: Header PWA & PWB.....	30
Figure 16: BMD Switch	34
Figure 17: Position BTM0=low	34
Figure 18: Position BTM1=low	34
Figure 19: Boot Mode Switch	35
Figure 20: Module MCU Connector.....	37
Figure 21: Carrier MCU Connector	38
Figure 22: MPX-Leds	45
Figure 23: GPU switch	46
Figure 24: GPU Power Off	46
Figure 25: GPU Power On	46
Figure 26: BMD Switch	46
Figure 27: MXM-Connector.....	47
Figure 28: JTAG Connector	55
Figure 29: TRST Connect	55
Figure 30: Battery Holder & Battery	58
Figure 31: HDMI Type A	60
Figure 32: LAN-Jack	61
Figure 33: miniPCIe Slot	62
Figure 34: mini PCIe Slot	62
Figure 35:Power Conector PWE1	62
Figure 36: mini PCI-E 4H Type I G/F	63
Figure 37: MIPI Configuration	64
Figure 38: micro SD-Card A.....	68
Figure 39: not fitted SDHC-B connector.....	69
Figure 40 micro USB.....	70
Figure 41 LIN Connector.....	70
Figure 42: CAN0 Terminal Block.....	71
Figure 43:CAN1 Terminal Block.....	71
Figure 44: CAN Termination Switch	72

Figure 45: Carrier Leds	73
Figure 46: MIPI-A Power Selection	76
Figure 47: MIPI-B Power Selection	76
Figure 48: JRS Link.....	76

10.3 Table of Tables

Table 1 Symbols	6
Table 2 Conventions	6
Table 3 Safety and Handling Precautions	7
Table 4: MXM Connector	54
Table 5 JTAG Header	55
Table 6 I ² C0 bus map.....	57
Table 7 I ² C1 bus map.....	57
Table 8 I ² C2 bus map.....	57
Table 9 DDC Function.....	59
Table 10 miniPCIe Slot pinout.....	63
Table 11 microSD card slot pin assignment.....	68
Table 12 microSD card slot pin assignment.....	69
Table 13 Document history	81

