

# Three Phase Half Controlled Rectifier Bridge, B6HK

$$I_{dAVM} = 110/167 \text{ A}$$

$$V_{RRM} = 1200-1600 \text{ V}$$

$V_{RSM}$ $V_{DSM}$ V	$V_{RRM}$ $V_{DRM}$ V	Type
1300	1200	VVZ 110-12io7
1700	1600	VVZ 175-12io7 VVZ 175-16io7

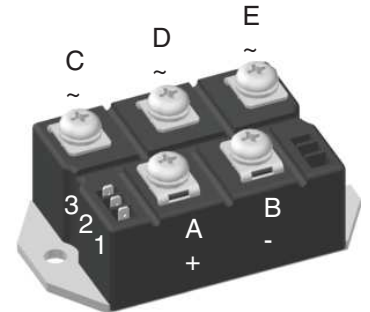
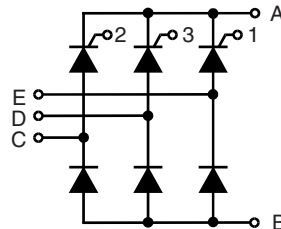

Symbol	Test Conditions	Maximum Ratings			
		VVZ 110	VVZ 175		
$I_{dAV}$	$T_C = 85^\circ\text{C}$ ; module per leg	110	167	A	
$I_{FRMS}, I_{TRMS}$		58	89	A	
$I_{FSM}, I_{TSM}$	$T_{VJ} = 45^\circ\text{C}$ ; $V_R = 0$	$t = 10 \text{ ms}$ (50 Hz), sine	1150	1500	A
		$t = 8.3 \text{ ms}$ (60 Hz), sine	1230	1600	A
$I^2t$	$T_{VJ} = T_{VJM}$ ; $V_R = 0$	$t = 10 \text{ ms}$ (50 Hz), sine	1000	1350	A
		$t = 8.3 \text{ ms}$ (60 Hz), sine	1070	1450	A
$(di/dt)_{cr}$	$T_{VJ} = 45^\circ\text{C}$ ; $V_R = 0$	$t = 10 \text{ ms}$ (50 Hz), sine	6600	11200	A <sup>2</sup> s
		$t = 8.3 \text{ ms}$ (60 Hz), sine	6280	10750	A <sup>2</sup> s
$(dv/dt)_{cr}$	$T_{VJ} = T_{VJM}$ ; $V_{DR} = 2/3 V_{DRM}$	$t = 10 \text{ ms}$ (50 Hz), sine	5000	9100	A <sup>2</sup> s
		$t = 8.3 \text{ ms}$ (60 Hz), sine	4750	8830	A <sup>2</sup> s
$(di/dt)_{cr}$	$T_{VJ} = T_{VJM}$ repetitive, $I_T = 50 \text{ A}$ $f = 400 \text{ Hz}$ , $t_p = 200 \mu\text{s}$ $V_D = 2/3 V_{DRM}$		150		A/ $\mu\text{s}$
	$I_G = 0.3 \text{ A}$ , non repetitive, $di_G/dt = 0.3 \text{ A}/\mu\text{s}$ , $I_T = 1/3 \cdot I_{dAV}$		500		A/ $\mu\text{s}$
$(dv/dt)_{cr}$	$T_{VJ} = T_{VJM}$ ; $V_{DR} = 2/3 V_{DRM}$ $R_{GK} = \infty$ ; method 1 (linear voltage rise)		1000		V/ $\mu\text{s}$
$V_{RGM}$			10		V
$P_{GM}$	$T_{VJ} = T_{VJM}$	$t_p = 30 \mu\text{s}$	$\leq 10$		W
	$I_T = I_{TAVM}$	$t_p = 500 \mu\text{s}$	$\leq 5$		W
		$t_p = 10 \text{ ms}$	$\leq 1$		W
$P_{GAVM}$			0.5		W
$T_{VJ}$			-40...+125		$^\circ\text{C}$
$T_{VJM}$			125		$^\circ\text{C}$
$T_{stg}$			-40...+125		$^\circ\text{C}$
$V_{ISOL}$	50/60 Hz, RMS $t = 1 \text{ min}$		2500		V~
	$I_{ISOL} \leq 1 \text{ mA}$ $t = 1 \text{ s}$		3000		V~
$M_d$	Mounting torque (M6)		5±15 %		Nm
	Terminal connection torque (M6)		5±15 %		Nm
Weight	typ.		300		g

## Features

- Package with screw terminals
- Isolation voltage 3000 V~
- Planar passivated chips
- UL registered E72873

## Applications

- Input rectifier for PWM converter
- Input rectifier for switch mode power supplies (SMPS)
- Softstart capacitor charging

## Advantages

- Easy to mount with two screws
- Space and weight savings
- Improved temperature and power cycling

Data according to IEC 60747 and refer to a single thyristor/diode unless otherwise stated.

## Disclaimer Notice

Information furnished is believed to be accurate and reliable. However, users should independently evaluate the suitability of and test each product selected for their own applications. Littelfuse products are not designed for, and may not be used in, all applications. Read complete Disclaimer Notice Disclaimer Notice at [www.littelfuse.com/disclaimer-electronics](http://www.littelfuse.com/disclaimer-electronics).

IXYS reserves the right to change limits, test conditions and dimensions.

20200117c

Symbol	Test Conditions	Characteristic Values		
		VVZ 110	VVZ 175	
$I_{R'} I_D$	$V_R = V_{RRM}; V_D = V_{DRM}$	$T_{VJ} = T_{VJM}$	≤ 5	mA
		$T_{VJ} = 25^\circ\text{C}$	≤ 0.3	mA
$V_F V_T$	$I_F I_T = 200 \text{ A}, T_{VJ} = 25^\circ\text{C}$	≤ 1.75	1.57	V
$V_{T0}$	For power-loss calculations only	0.85	0.85	V
$r_T$	( $T_{VJ} = 125^\circ\text{C}$ )	6	3.5	mΩ
$V_{GT}$	$V_D = 6 \text{ V};$	$T_{VJ} = 25^\circ\text{C}$	≤ 1.5	V
		$T_{VJ} = -40^\circ\text{C}$	≤ 1.6	V
$I_{GT}$	$V_D = 6 \text{ V};$	$T_{VJ} = 25^\circ\text{C}$	≤ 100	mA
		$T_{VJ} = -40^\circ\text{C}$	≤ 200	mA
$V_{GD}$	$T_{VJ} = T_{VJM}; V_D = \frac{2}{3} V_{DRM}$	≤ 0.2	0.2	V
$I_{GD}$	$T_{VJ} = T_{VJM}; V_D = \frac{2}{3} V_{DRM}$	≤ 5	5	mA
$I_L$	$I_G = 0.3 \text{ A}; t_G = 30 \mu\text{s}; T_{VJ} = 25^\circ\text{C}$ $di_G/dt = 0.3 \text{ A}/\mu\text{s}$	≤ 450	450	mA
$I_H$	$T_{VJ} = 25^\circ\text{C}; V_D = 6 \text{ V}; R_{GK} = \infty$	≤ 200	200	mA
$t_{gd}$	$T_{VJ} = 25^\circ\text{C}; V_D = \frac{1}{2} V_{DRM}$ $I_G = 0.3 \text{ A}; di_G/dt = 0.3 \text{ A}/\mu\text{s}$	≤ 2	2	μs
$R_{thJC}$	per thyristor (diode); DC current per module	0.65	0.46	K/W
		0.108	0.077	K/W
$R_{thJH}$	per thyristor (diode); DC current per module	0.8	0.55	K/W
		0.133	0.092	K/W
$d_s$	Creeping distance on surface	10	10	mm
$d_A$	Creepage distance in air	9.4	9.4	mm
$a$	Max. allowable acceleration	50	50	m/s <sup>2</sup>

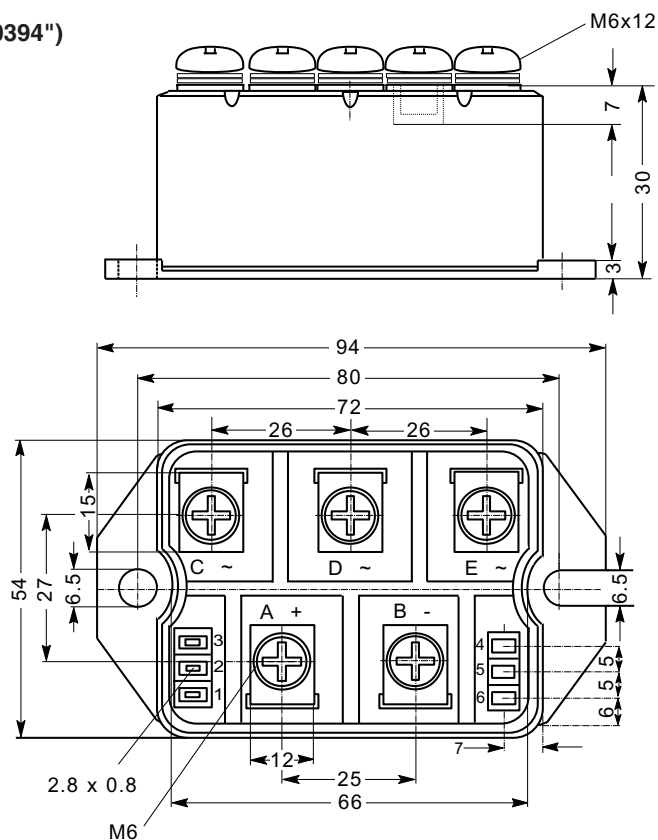
**Dimensions in mm (1 mm = 0.0394")**

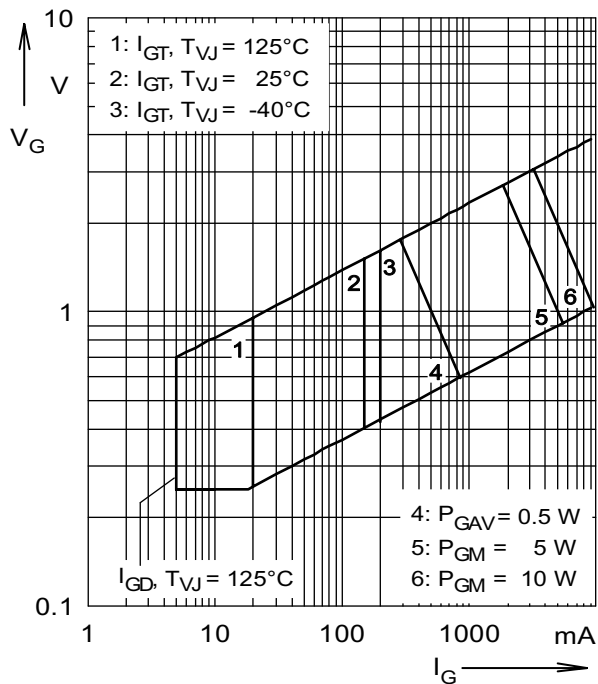

Fig. 1 Gate trigger characteristics

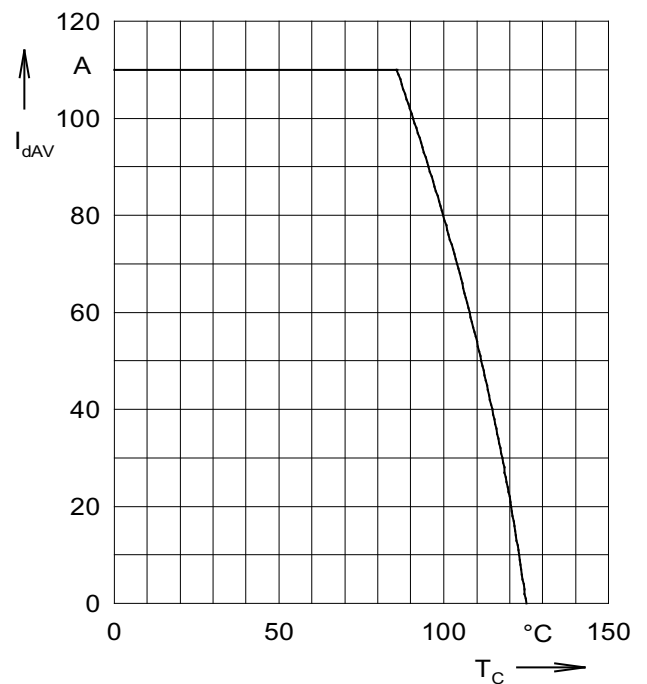

Fig. 2 DC output current at case temperature

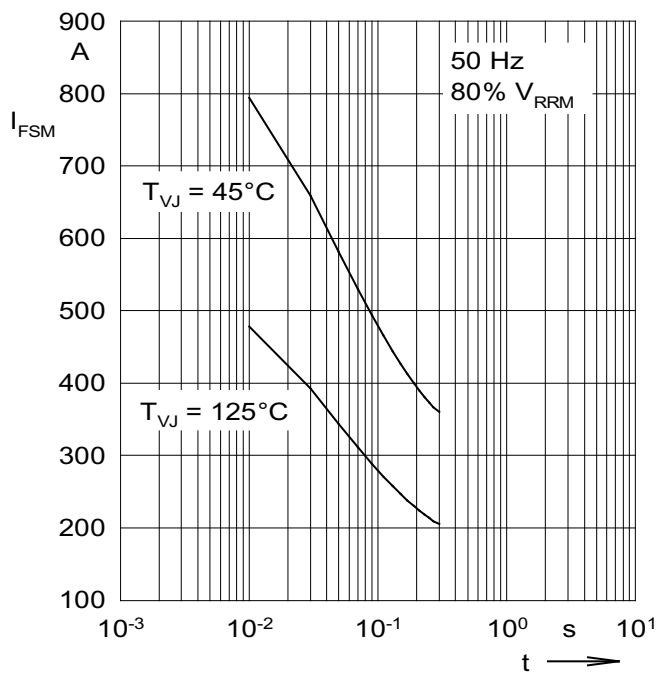

Fig. 3 Surge overload current  
 $I_{FSM}$ : Crest value,  $t$ : duration

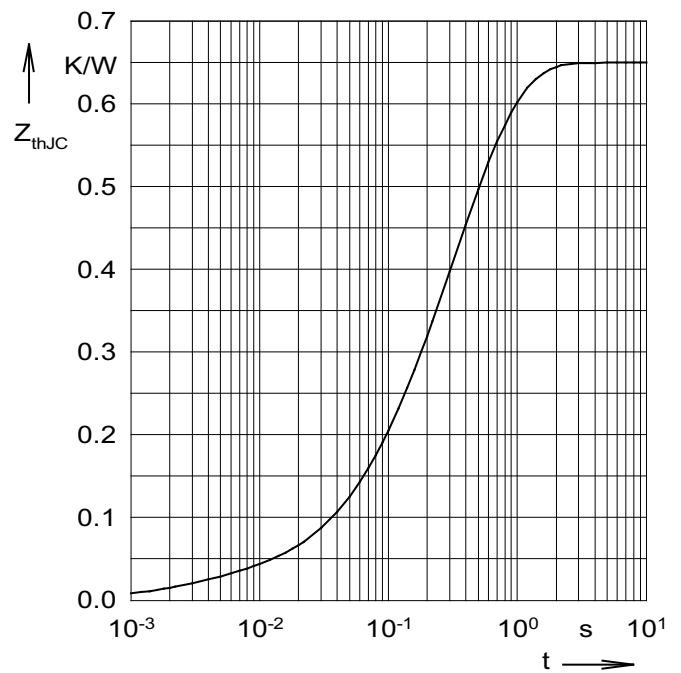

Fig. 4 Transient thermal impedance  
junction to case (per leg)