

- Low-loss RF SAW Filter
- 3.0 x 3.0 x 1.4 mm Surface-mount Case
- No Matching Required for 50 Ω Operation
- Complies with Directive 2002/95/EC (RoHS)

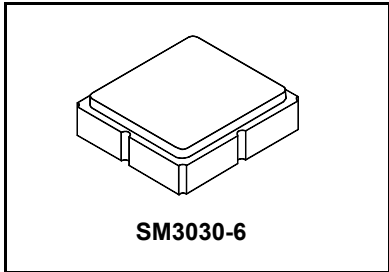

SF2252E

**1590 MHz
SAW Filter**



Absolute Maximum Ratings

Rating	Value	Units
Incident Power in Passband	+10	dBm
DC Voltage on any Non-ground Terminal	3	VDC
Operating Temperature Range	-55 to +85	°C
Storage Temperature Range in Tape and Reel	-40 to +85	°C
Maximum Soldering Profile, 5 cycles/ 10 seconds maximum	265	°C

Electrical Characteristics

Characteristic	Sym	Notes	Min	Typ	Max	Units
Center Frequency	f_C			1590		MHz
Minimum Insertion Loss	IL			2.3	4.0	dB
Amplitude Ripple				1.0	1.8	dB _{P-P}
1.2 dB Bandwidth	BW _{1.2}		55	59	65	MHz
20 dB Bandwidth	BW ₂₀			97	125	MHz
Ultimate Rejection				50		dB
Terminating Source impedance	Z _L			50		Ω
Terminating Load impedance	Z _L			50		Ω
Single Ended Input / Output Impedance match	No matching network required for operation at 50 ohms					
Case Style	SM3030-6					
Lid Symbolization	993					



CAUTION: Electrostatic Sensitive Device. Observe precautions for handling.

NOTES:

1. US and international patents may apply.
2. Murata, stylized Murata logo, and Murata N.A., Inc. are registered trademarks of Murata Manufacturing Co., Ltd.

Matching Circuit

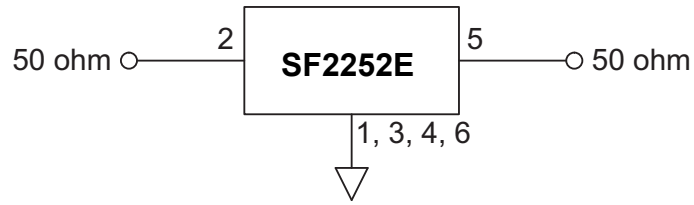

Frequency Response Plots

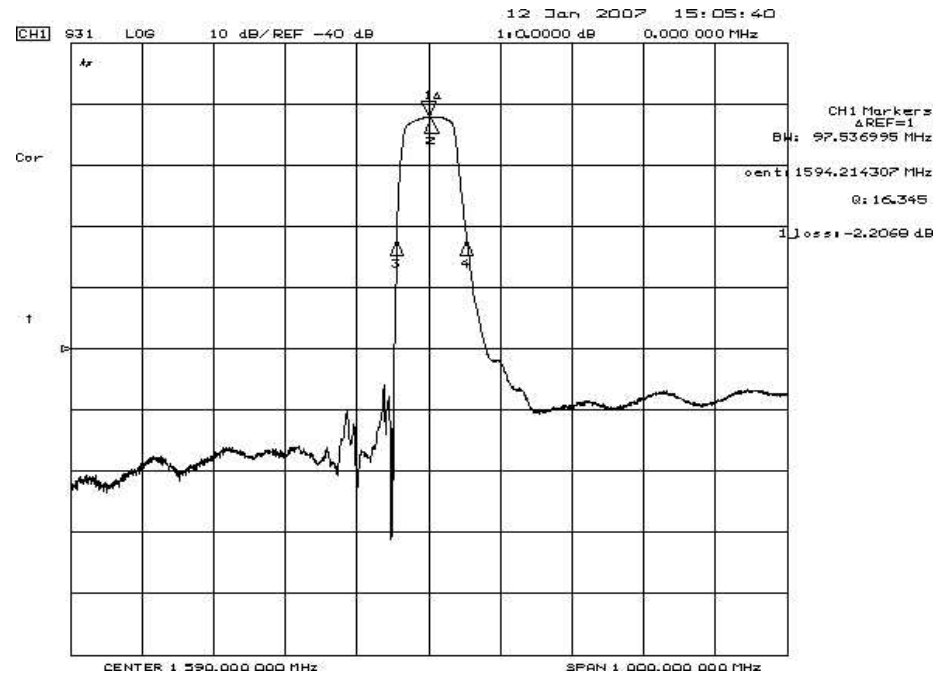
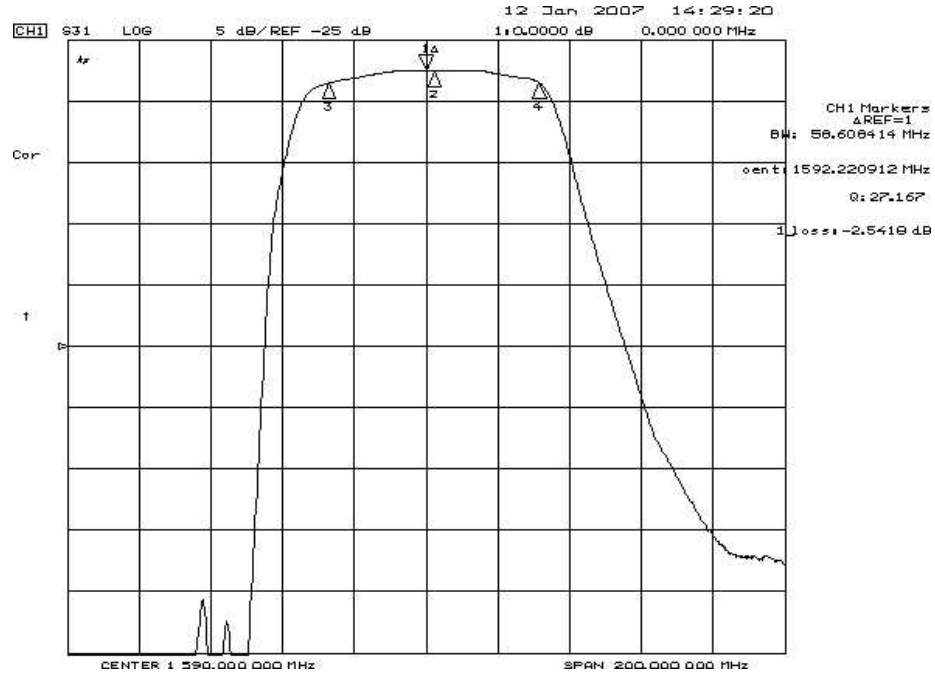

VSWR Plots

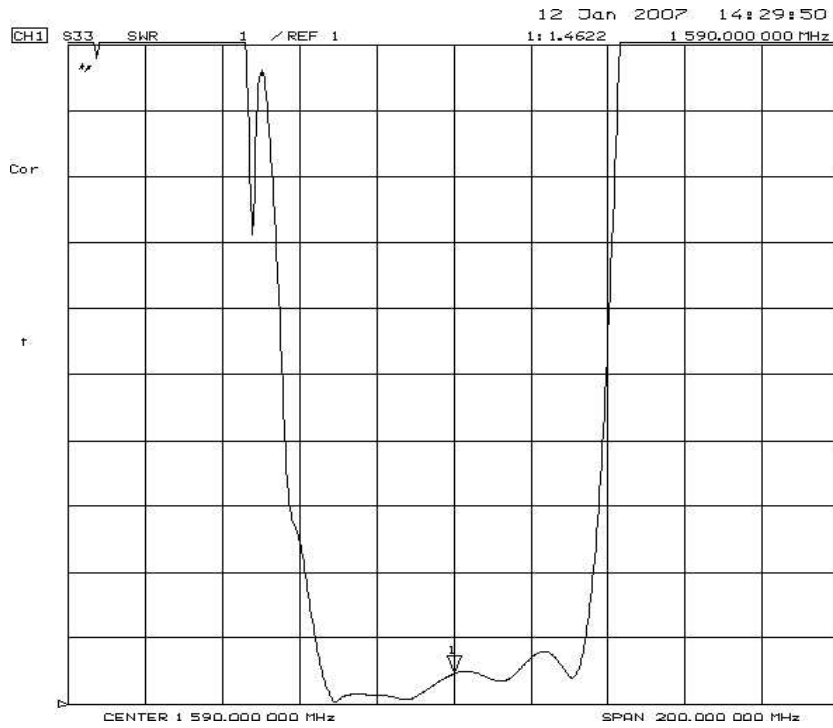
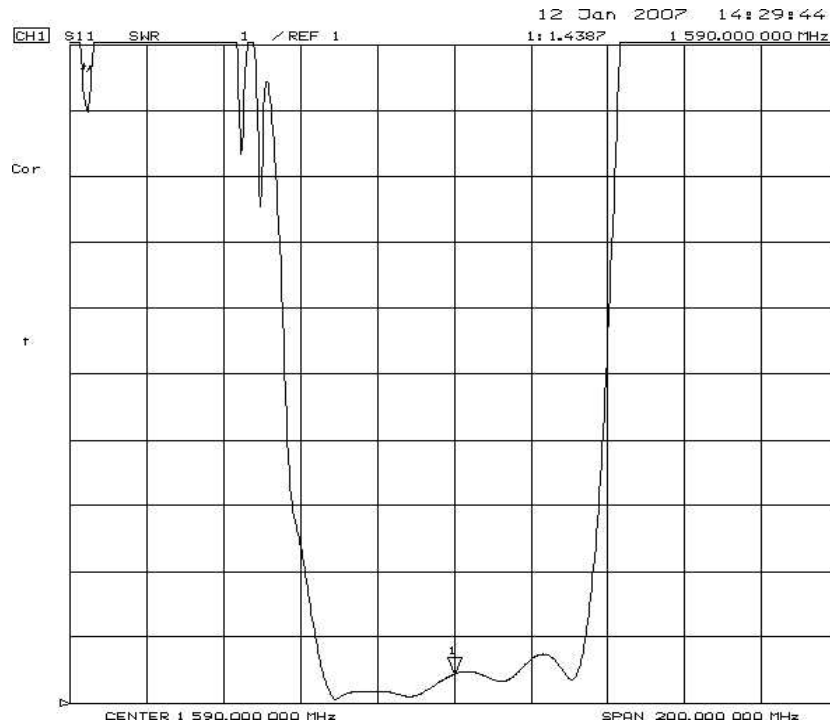

6-Terminal Ceramic Surface-Mount Case 3.0 X 3.0 mm Nominal Footprint

Case and PCB Footprint Dimensions

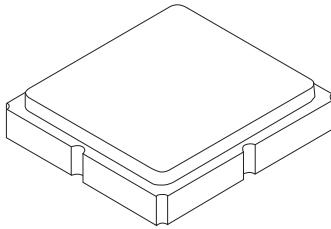

PCB Footprint Top View

Dimension	mm			Inches		
	Min	Nom	Max	Min	Nom	Max
A	2.87	3.00	3.13	0.113	0.118	0.123
B	2.87	3.00	3.13	0.113	0.118	0.123
C	1.12	1.25	1.38	0.044	0.049	0.054
D	0.77	0.90	1.03	0.030	0.035	0.040
E	2.67	2.80	2.93	0.105	0.110	0.115
F	1.47	1.60	1.73	0.058	0.063	0.068
G	0.72	0.85	0.98	0.028	0.033	0.038
H	1.37	1.50	1.63	0.054	0.059	0.064
I	0.47	0.60	0.73	0.019	0.024	0.029
J	1.17	1.30	1.43	0.046	0.051	0.056
K		3.20			0.126	
L		1.70			0.067	
M		1.05			0.041	
N		0.81			0.032	
O		0.38			0.015	

Case Materials

Materials	
Solder Pad Plating	0.3 to 1.0 μm Gold over 1.27 to 8.89 μm Nickel
Lid Plating	2.0 to 3.0 μm Nickel
Body	Al_2O_3 Ceramic
Pb Free	

TOP VIEW

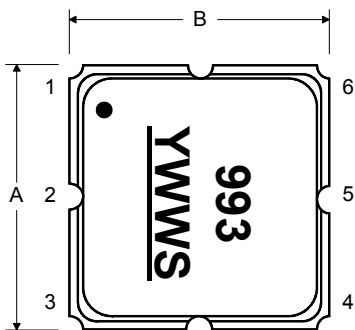

BOTTOM VIEW

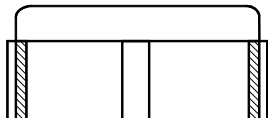
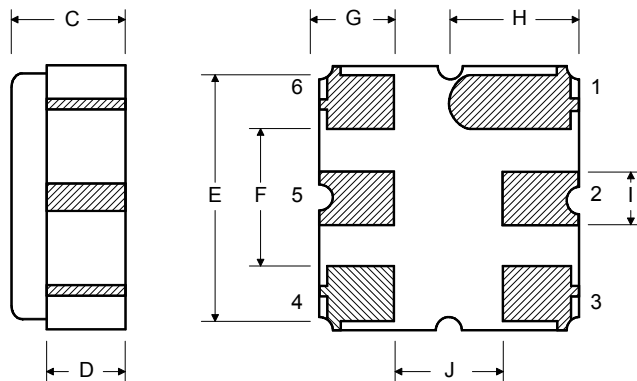

Tape and Reel Specifications

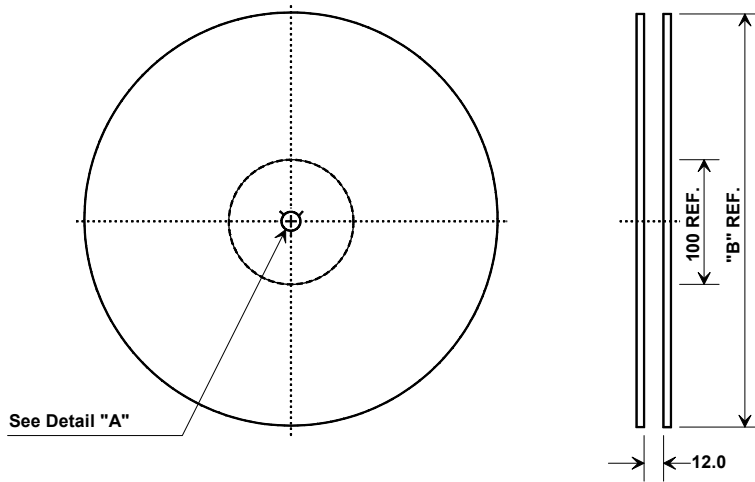

"B"		Quantity Per Reel
Inches	millimeters	
7	178	500
13	330	3000

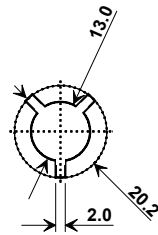

COMPONENT ORIENTATION and DIMENSIONS

Carrier Tape Dimensions	
Ao	3.35 mm
Bo	3.35 mm
Ko	1.40 mm
Pitch	8.0 mm
W	12.0 mm

