

Precision 300MHz to 7GHz RF Detector with Gain and Offset Adjustment

FEATURES

- Temperature Compensated Internal Schottky Diode RF Detector
- Wide Input Frequency Range: 300MHz to 7GHz*
- Wide Input Power Range: -32dBm to 10dBm
- Buffered Detector Output with External Gain Control
- Precision V_{OUT} Offset Control
- Low Starting Voltage: 120mV \pm 35mV for Gain = 2x
- Wide V_{CC} Range of 2.7V to 6V
- Low Operating Current: 500 μ A
- Available in a Low Profile (1mm) SOT-23 Package and Tiny 6-Lead (2mm \times 2mm) DFN Package

APPLICATIONS

- 802.11a, 802.11b, 802.11g, 802.15
- Multimode Mobile Phone Products
- Optical Data Links
- Wireless Data Modems
- Wireless and Cable Infrastructure
- RF Power Alarm
- Envelope Detector

DESCRIPTION

The LTC[®]5532 is an RF power detector for RF applications operating in the 300MHz to 7GHz range. A temperature compensated Schottky diode peak detector and buffer amplifier are combined in a small ThinSOT[™] or (2mm \times 2mm) DFN package. The supply voltage range is optimized for operation from a single lithium-ion cell or 3 \times NiMH.

The RF input voltage is peak detected using an on-chip Schottky diode. The detected voltage is buffered and supplied to the V_{OUT} pin.

The LTC5532 output buffer gain is set via external resistors. The initial starting voltage of 120mV \pm 35mV can be precisely adjusted using the V_{OS} pin.

The LTC5532 operates with RF input power levels from -32dBm to 10dBm.

LT, LTC and LT are registered trademarks of Linear Technology Corporation. ThinSOT is a trademark of Linear Technology Corporation.

*Higher frequency operation is achievable with reduced performance. Consult factory for more information.

TYPICAL APPLICATION

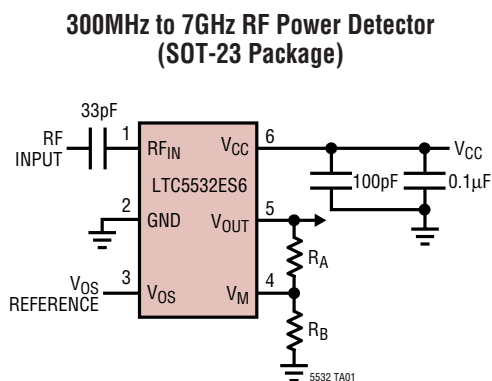

**Output Voltage vs RF Input Power
(SOT-23 Package)**

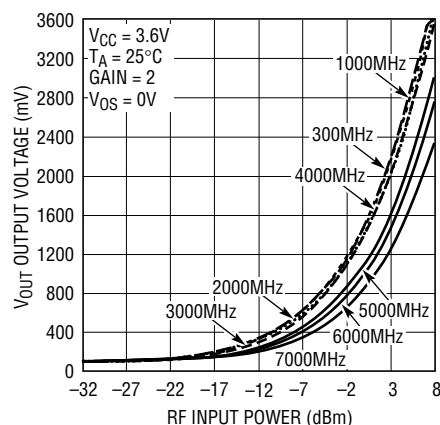

5532 TA02

ABSOLUTE MAXIMUM RATINGS (Note 1)

V_{CC} , V_{OUT} , V_M , V_{OS}	-0.3V to 6.5V	Maximum Junction Temperature	125°C
R_{FIN} Voltage	($V_{CC} \pm 1.5V$) to 7V	Storage Temperature Range	-65°C to 125°C
R_{FIN} Power (RMS)	12dBm	Lead Temperature (Soldering, 10 sec)	
I_{VOUT}	5mA	SOT-23 Only	300°C
Operating Temperature Range (Note 2) ..	-40°C to 85°C		

PACKAGE/ORDER INFORMATION

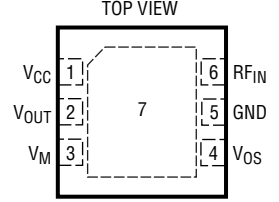
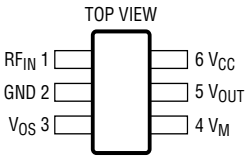
 <p>DC6 PACKAGE 6-LEAD (2mm x 2mm) PLASTIC DFN $T_{JMAX} = 125^{\circ}C$, $\theta_{JA} = 85^{\circ}C/W$ EXPOSED PAD (PIN 7) IS GND, MUST BE SOLDERED TO PCB</p>	ORDER PART NUMBER	 <p>S6 PACKAGE 6-LEAD PLASTIC TSOT-23 $T_{JMAX} = 125^{\circ}C$, $\theta_{JA} = 250^{\circ}C/W$</p>	ORDER PART NUMBER
	LTC5532EDC		LTC5532ES6
	DC6 PART MARKING		S6 PART MARKING
	LAFR		LTAFS

Consult LTC Marketing for parts specified with wider operating temperature ranges.

ELECTRICAL CHARACTERISTICS

The ● denotes the specifications which apply over the full operating temperature range, otherwise specifications are at $T_A = 25^{\circ}C$. $V_{CC} = 3.6V$, RF Input Signal is Off, $R_A = R_B = 1k$, $V_{OS} = 0V$ unless otherwise noted (Note 2).

PARAMETER	CONDITIONS	MIN	TYP	MAX	UNITS
V_{CC} Operating Voltage		● 2.7		6	V
I_{VCC} Operating Current	$I_{VOUT} = 0mA$	●	0.5	0.7	mA
V_{OUT} V_{OL} (No RF Input)	$R_{LOAD} = 2k$, $V_{OS} = 0V$	● 85	100 to 140	155	mV
V_{OUT} Output Current	$V_{OUT} = 1.75V$, $V_{CC} = 2.7V$, $\Delta V_{OUT} < 10mV$	● 2	4		mA
V_{OUT} Bandwidth	$C_{LOAD} = 33pF$, $R_{LOAD} = 2k$ (Note 4)		2		MHz
V_{OUT} Load Capacitance	(Note 6)	●		33	pF
V_{OUT} Slew Rate	$V_{RFIN} = 1V$ Step, $C_{LOAD} = 33pF$, Total $R_{LOAD} = 2k$ (Note 3)		3		V/ μs
V_{OUT} Noise	$V_{CC} = 3V$, Noise BW = 1.5MHz, 50 Ω RF Input Termination, 50 Ω AC Output Termination		1		mV _{p-p}
V_{OS} Voltage Range		● 0		1	V
V_{OS} Input Current	$V_{OS} = 1V$	● -0.5		0.5	μA
V_M Voltage Range		● 0		$V_{CC} - 1.8$	V
V_M Input Current	$V_M = 3.6V$	● -0.5		0.5	μA
R_{FIN} Input Frequency Range	(Note 7)		300 to 7000		MHz
R_{FIN} Input Power Range	RF Frequency = 300MHz to 7GHz (Note 5, 6) $V_{CC} = 2.7V$ to 6V		-32 to 10		dBm
R_{FIN} AC Input Resistance	$F = 1000MHz$, $Pin = -25dBm$		220		Ω
R_{FIN} Input Shunt Capacitance	$F = 1000MHz$, $Pin = -25dBm$		0.65		pF

Note 1: Absolute Maximum Ratings are those values beyond which the life of a device may be impaired.

Note 2: Specifications over the -40°C to 85°C operating temperature range are assured by design, characterization and correlation with statistical process controls.

Note 3: The rise time at V_{OUT} is measured between 1.3V and 2.3V.

Note 4: Bandwidth is calculated based on the 10% to 90% rise time equation: $BW = 0.35/\text{rise time}$.

Note 5: RF performance is tested at 1800MHz

Note 6: Guaranteed by design.

Note 7: Higher frequency operation is achievable with reduced performance. Consult factory for more information.

TYPICAL PERFORMANCE CHARACTERISTICS ($R_{LOAD} = 20k$) Characteristics are for both packages unless otherwise indicated.

Output Voltage vs Supply Voltage (RF Input Signal Off)

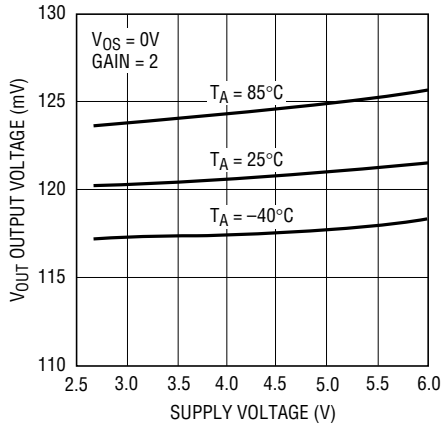

5532 G01

Supply Current vs Supply Voltage (RF Input Signal Off)

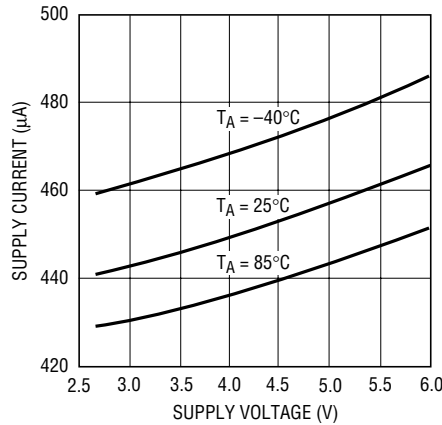

5532 G02

Output Delay vs RF Input Power

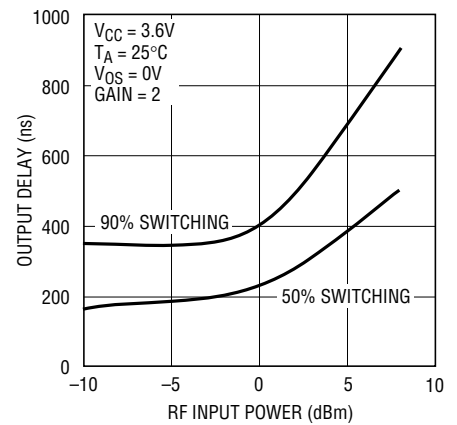

5532 G03

Typical Detector Characteristics, 300MHz, Gain = 2, VOS = 0V

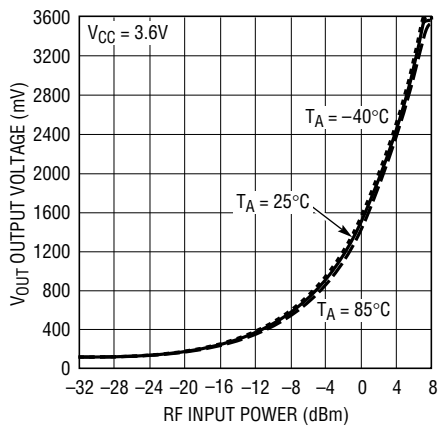

5532 G04

Typical Detector Characteristics, 1000MHz, Gain = 2, VOS = 0V

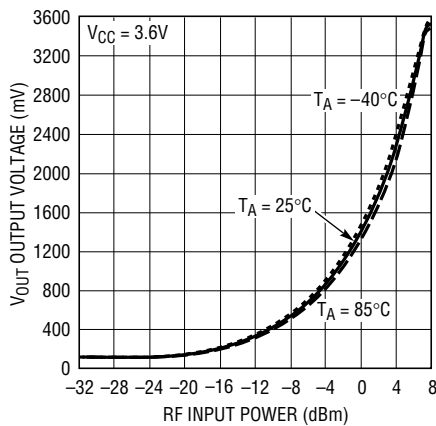

5532 G05

Typical Detector Characteristics, 2000MHz, Gain = 2, VOS = 0V

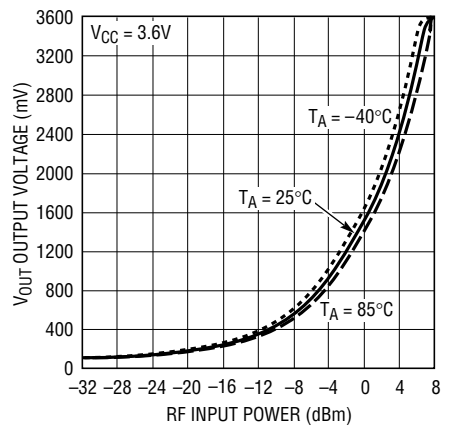

5532 G06

Typical Detector Characteristics, 3000MHz, Gain = 2, VOS = 0V

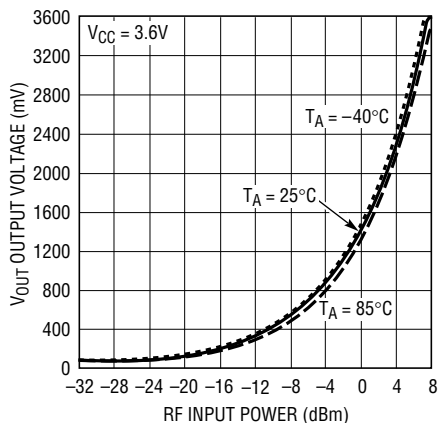

5532 G07

Typical Detector Characteristics, 4000MHz, Gain = 2, VOS = 0V

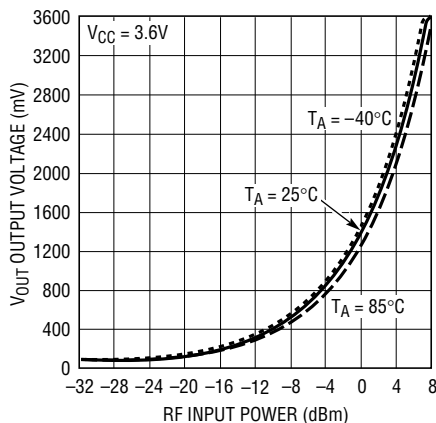

5532 G08

Typical Detector Characteristics, 5000MHz, Gain = 2, VOS = 0V (SOT-23 Package)

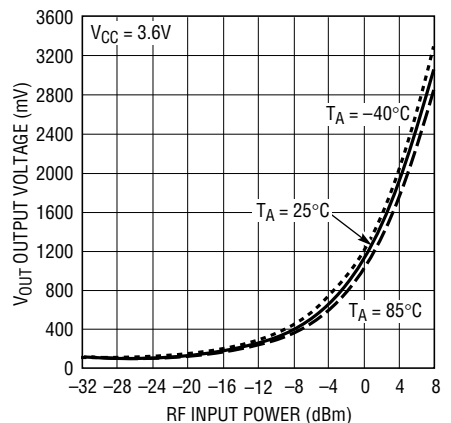

5532 G09

5532f

TYPICAL PERFORMANCE CHARACTERISTICS ($R_{LOAD} = 20k$) Characteristics are for both packages unless otherwise indicated.

Typical Detector Characteristics, 6000MHz, Gain = 2, $V_{OS} = 0V$ (SOT-23 Package)

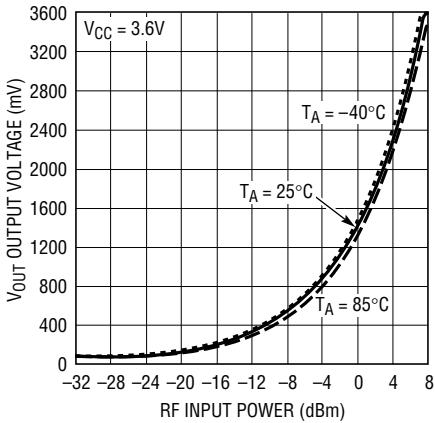

5532 G07

Typical Detector Characteristics, 7000MHz, Gain = 2, $V_{OS} = 0V$ (SOT-23 Package)

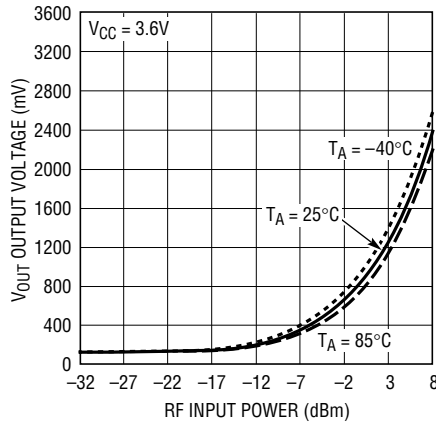

5532 G11

Typical Detector Characteristics, 300MHz, Gain = 4, $V_{OS} = 0V$

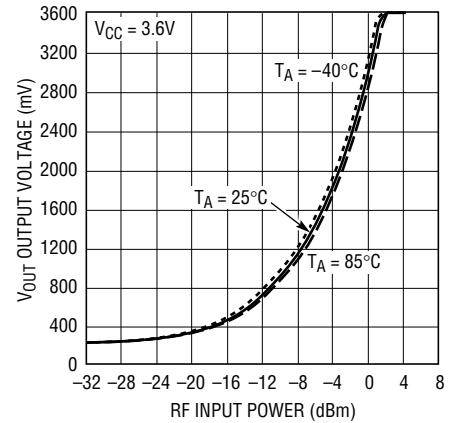

5532 G12

Typical Detector Characteristics, 1000MHz, Gain = 4, $V_{OS} = 0V$

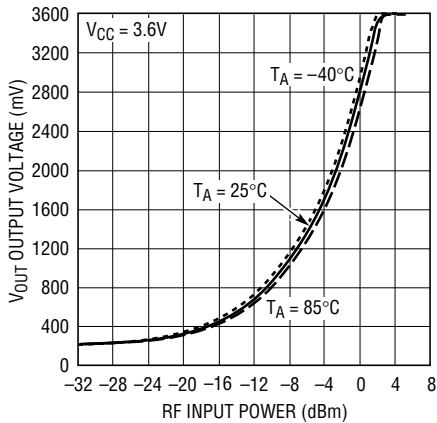

5532 G13

V_{OUT} vs RF Input Power and V_{OS} , 300MHz, Gain = 2

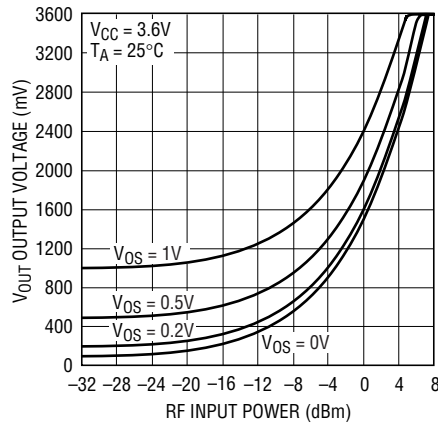

5532 G14

V_{OUT} vs RF Input Power and V_{OS} , 1000MHz, Gain = 2

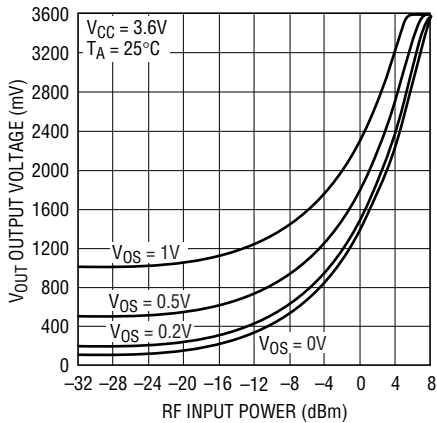

5532 G15

V_{OUT} vs RF Input Power, 300MHz and 1000MHz, Gain = 2 and 4, $V_{OS} = 0V$

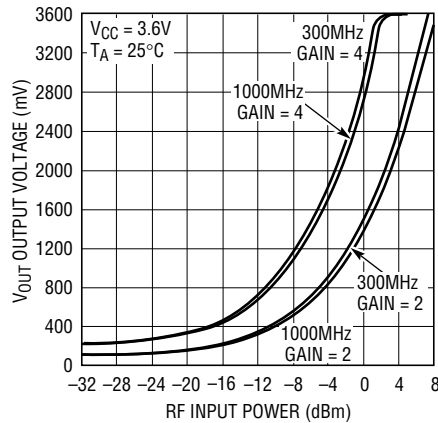

5532 G16

TYPICAL PERFORMANCE CHARACTERISTICS ($R_{LOAD} = 20k$) Characteristics are for both packages unless otherwise indicated.

V_{OUT} Slope vs RF Input Power at 300MHz

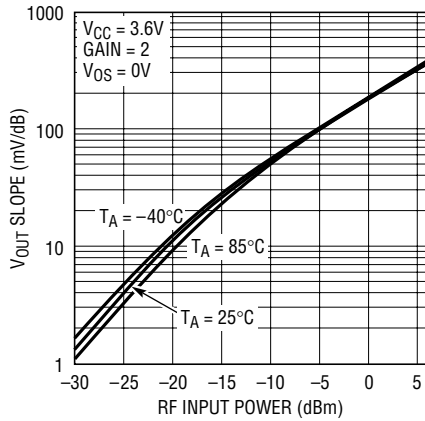

V_{OUT} Slope vs RF Input Power at 1000MHz

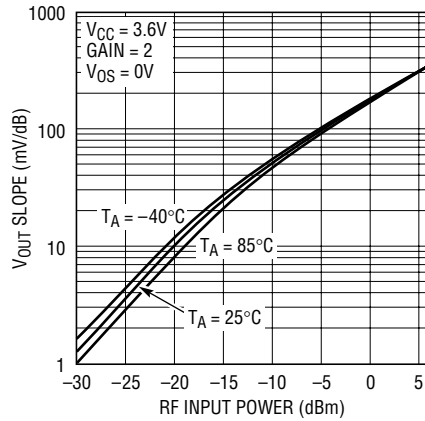

V_{OUT} Slope vs RF Input Power at 2000MHz

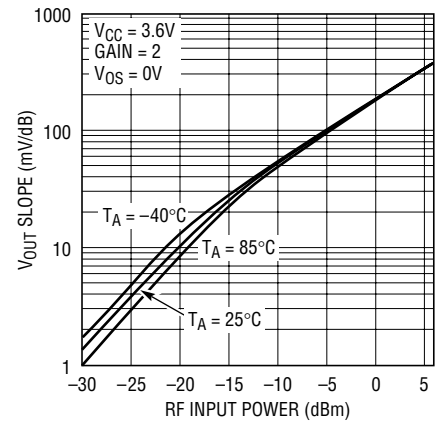

V_{OUT} Slope vs RF Input Power at 3000MHz

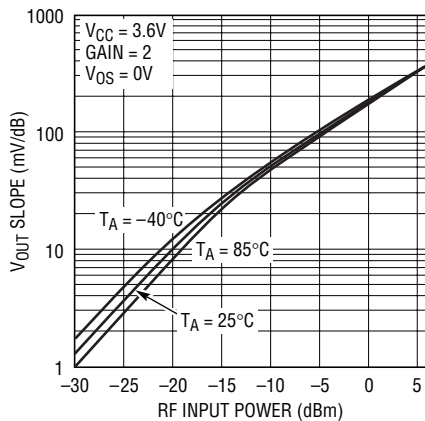

V_{OUT} Slope vs RF Input Power at 4000MHz

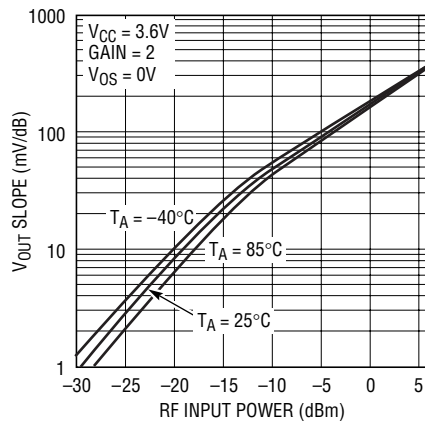

V_{OUT} Slope vs RF Input Power at 5000MHz (SOT-23 Package)

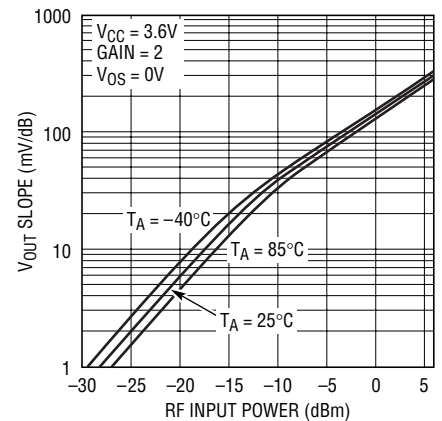

V_{OUT} Slope vs RF Input Power at 6000MHz (SOT-23 Package)

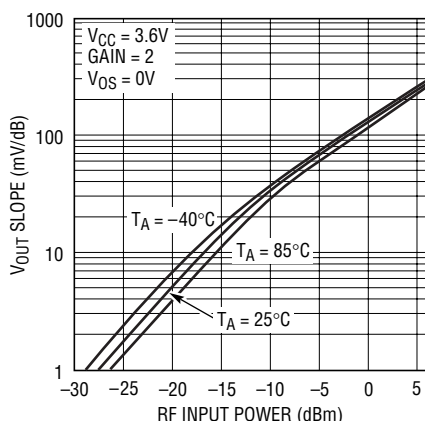

V_{OUT} Slope vs RF Input Power at 7000MHz (SOT-23 Package)

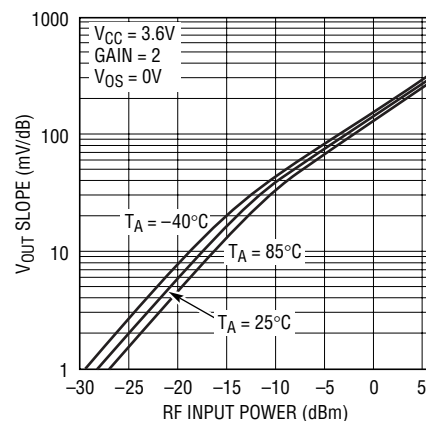

TYPICAL PERFORMANCE CHARACTERISTICS (DFN package, $R_{LOAD} = 20k$)

Typical Detector Characteristics
5000MHz, Gain = 2, $V_{OS} = 0V$
(DFN Package)

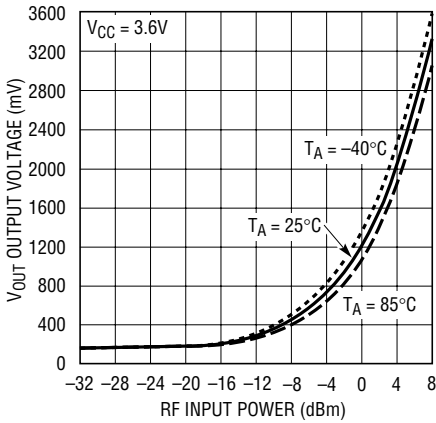

5532 G25

Typical Detector Characteristics
6000MHz, Gain = 2, $V_{OS} = 0V$
(DFN Package)

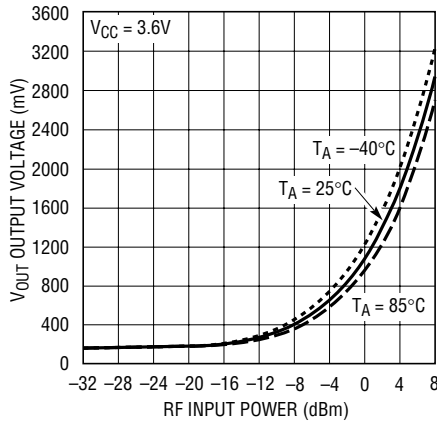

5532 G26

Typical Detector Characteristics
7000MHz, Gain = 2, $V_{OS} = 0V$
(DFN Package)

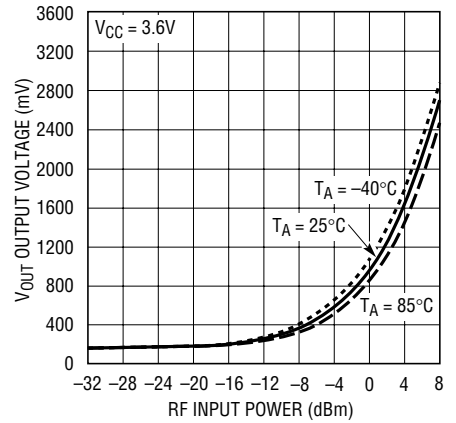

5532 G27

Output Voltage vs RF Input Power
(DFN Package)

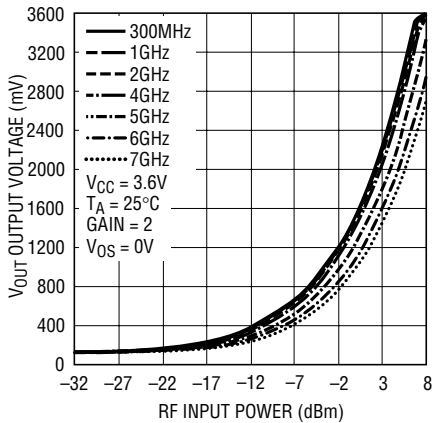

5532 G28

V_{OUT} Slope vs RF Input Power
at 5000MHz (DFN Package)

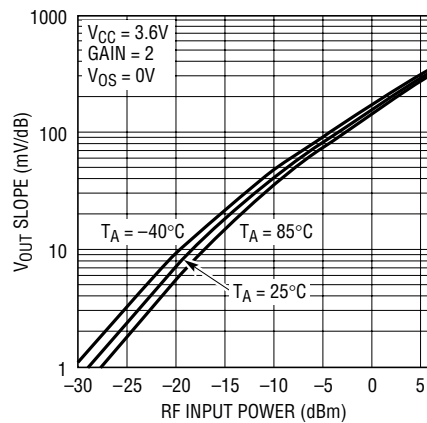

5532 G29

V_{OUT} Slope vs RF Input Power
at 6000MHz (DFN Package)

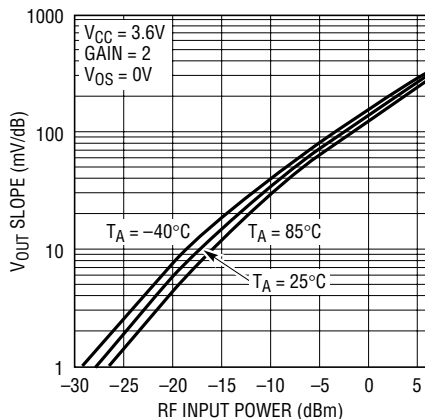

5532 G30

V_{OUT} Slope vs RF Input Power
at 7000MHz (DFN Package)

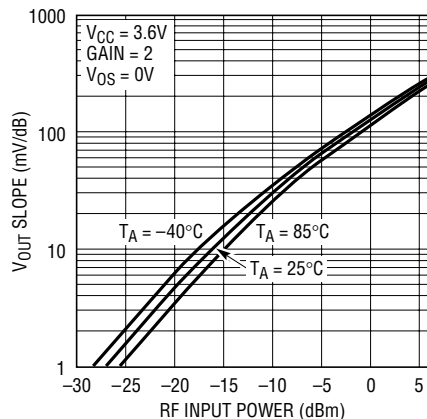

5532 G31

TYPICAL PERFORMANCE CHARACTERISTICS (SOT-23 Package)

RF_{IN} Input Impedance (Pin = 0dBm, V_{CC} = 3.6V, T_A = 25°C)

FREQUENCY (GHz)	RESISTANCE (Ω)	REACTANCE (Ω)
0.30	290.45	-136.22
0.50	234.41	-162.54
0.70	178.25	-170.53
0.90	137.31	-159.89
1.10	109.17	-147.57
1.30	86.30	-136.18
1.50	68.65	-121.74
1.70	57.48	-107.60
1.90	49.79	-96.72
2.10	43.56	-86.70
2.30	38.67	-77.91
2.50	34.82	-70.13
2.70	31.68	-62.86
2.90	29.13	-56.01
3.10	27.17	-49.83
3.30	25.73	-44.24
3.50	24.56	-39.74
3.70	23.18	-35.35
3.90	22.31	-30.62
4.10	20.73	-26.88
4.30	19.88	-22.31
4.50	19.40	-18.23
4.70	19.05	-14.25
4.90	19.08	-10.21
5.10	19.55	-6.30
5.30	20.85	-2.84
5.50	21.94	-1.49
5.70	20.60	-0.07
5.90	19.29	2.99
6.10	18.69	6.61
6.30	18.53	10.39
6.50	18.74	14.35
6.70	19.79	17.91
6.90	19.75	20.77
7.00	19.99	22.47

S11 Forward Reflection
Impedance

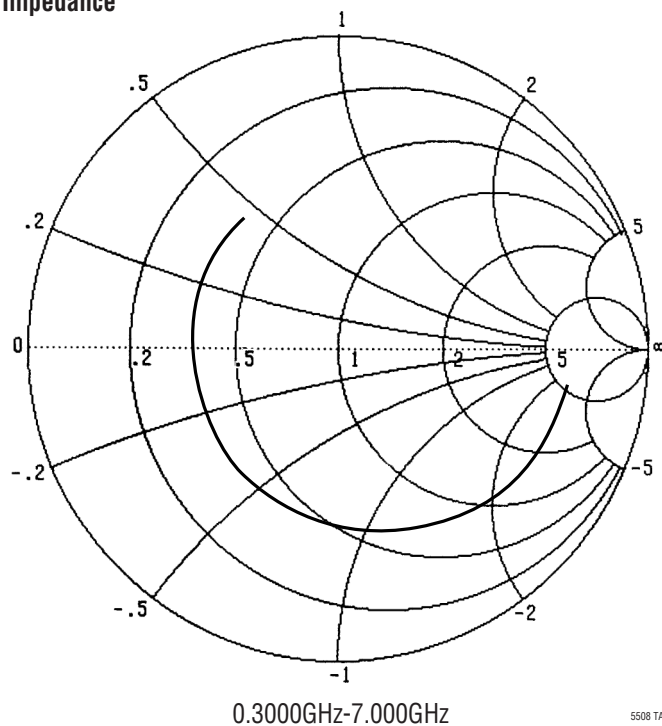

5508 TA03

TYPICAL PERFORMANCE CHARACTERISTICS (SOT-23 Package)

RF_{IN} Input Impedance (P_{in} = -25dBm, V_{CC} = 3.6V, T_A = 25°C)

FREQUENCY (GHz)	RESISTANCE (Ω)	REACTANCE (Ω)
0.30	216.45	-76.47
0.50	190.63	-98.28
0.70	161.98	-112.03
0.90	133.17	-111.53
1.10	113.08	-109.05
1.30	94.55	-107.08
1.50	75.33	-98.50
1.70	63.52	-88.19
1.90	55.19	-80.05
2.10	48.64	-72.23
2.30	43.73	-64.81
2.50	39.71	-58.31
2.70	36.47	-52.27
2.90	33.69	-46.77
3.10	31.61	-41.25
3.30	29.78	-36.61
3.50	28.27	-32.39
3.70	26.63	-28.12
3.90	26.12	-23.97
4.10	24.20	-20.75
4.30	23.28	-16.69
4.50	22.60	-12.77
4.70	22.21	-9.08
4.90	22.15	-5.24
5.10	22.61	-1.58
5.30	23.90	1.53
5.50	24.97	2.62
5.70	23.51	4.00
5.90	22.25	6.94
6.10	21.57	10.62
6.30	21.43	14.02
6.50	21.69	17.77
6.70	22.68	21.24
6.90	22.81	24.21
7.00	23.07	25.56

S11 Forward Reflection Impedance

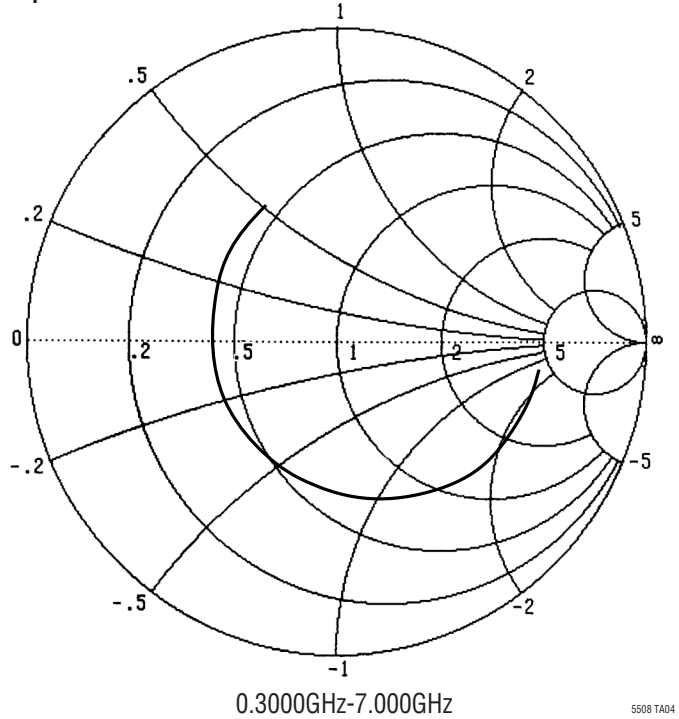

5508 TA04

TYPICAL PERFORMANCE CHARACTERISTICS (DFN Package)

RF_{IN} Input Impedance (P_{in} = 0dBm, V_{CC} = 3.6V, T_A = 25°C)

FREQUENCY (GHz)	RESISTANCE (Ω)	REACTANCE (Ω)
0.30	305.23	-144.87
0.50	238.58	-173.62
0.70	185.32	-177.82
0.90	142.06	-167.59
1.10	111.93	-152.80
1.30	90.59	-139.47
1.50	75.22	-126.45
1.70	63.37	-114.14
1.90	53.84	-103.83
2.10	47.11	-94.33
2.30	41.34	-85.18
2.50	37.00	-76.93
2.70	33.60	-69.47
2.90	30.96	-62.66
3.10	28.55	-56.74
3.30	26.36	-51.02
3.50	24.52	-45.95
3.70	23.12	-40.97
3.90	22.01	-36.25
4.10	21.13	-31.82
4.30	20.44	-27.51
4.50	19.85	-23.69
4.70	19.42	-20.18
4.90	19.03	-16.54
5.10	18.78	-12.88
5.30	18.69	-9.21
5.50	18.80	-5.72
5.70	19.09	-2.32
5.90	19.68	0.85
6.10	20.05	3.49
6.30	20.18	6.37
6.50	20.35	9.23
6.70	19.84	12.37
6.90	19.81	15.97
7.00	19.95	17.83

S11 Forward Reflection Impedance

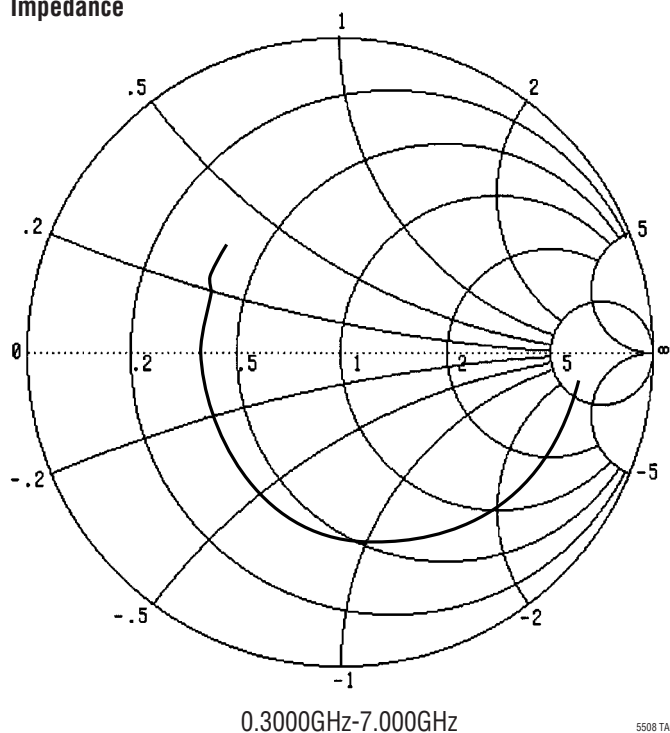

TYPICAL PERFORMANCE CHARACTERISTICS (DFN Package)

RF_{IN} Input Impedance (P_{in} = -25dBm, V_{CC} = 3.6V, T_A = 25°C)

FREQUENCY (GHz)	RESISTANCE (Ω)	REACTANCE (Ω)
0.30	225.19	-79.32
0.50	196.59	-105.44
0.70	166.23	-114.07
0.90	137.24	-115.88
1.10	114.69	-111.94
1.31	96.83	-106.10
1.50	83.12	-99.28
1.70	72.11	-92.73
1.90	61.69	-85.98
2.10	53.76	-78.71
2.31	47.46	-71.16
2.51	42.60	-64.52
2.70	39.04	-58.61
2.90	36.25	-53.23
3.10	33.41	-48.13
3.30	30.78	-43.37
3.50	28.85	-38.83
3.70	27.28	-34.09
3.90	26.08	-29.73
4.10	24.97	-25.80
4.30	24.18	-21.94
4.50	23.43	-18.27
4.70	22.88	-15.04
4.90	22.41	-11.56
5.10	22.09	-8.08
5.30	21.82	-4.34
5.50	21.91	-1.29
5.70	22.08	2.15
5.90	22.84	5.32
6.10	23.75	7.51
6.30	23.32	9.47
6.50	22.57	12.41
6.70	22.17	15.79
6.90	22.20	19.34
7.00	22.27	21.21

S11 Forward Reflection Impedance

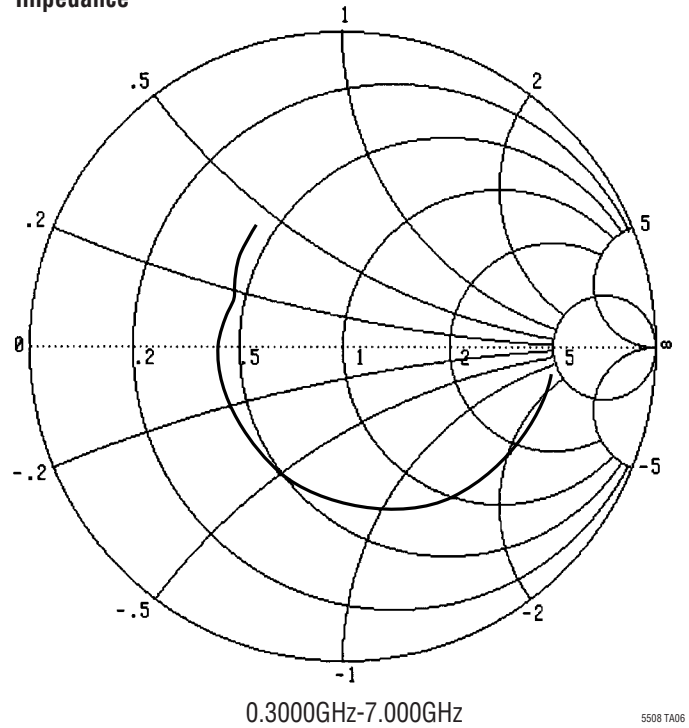

5508 TA06

PIN FUNCTIONS (SOT-23/DFN)

RF_{IN} (Pin 1/Pin 6): RF Input Voltage. Referenced to V_{CC}. A coupling capacitor must be used to connect to the RF signal source. The frequency range is 300MHz to 7GHz. This pin has an internal 500Ω termination, an internal Schottky diode detector and a peak detector capacitor. Operation at higher frequencies is achievable, consult factory for more information.

GND (Pin 2/Pin 5): Ground.

V_{OS} (Pin 3/Pin 4): V_{OUT} Offset Voltage Adjustment. From 0V to 120mV, V_{OUT} does not change. Above 120mV, V_{OUT} will track V_{OS}.

V_M (Pin 4/Pin 3): Inverting Input to Buffer Amplifier.

V_{OUT} (Pin 5/Pin 2): Detector Output.

V_{CC} (Pin 6/Pin 1): Power Supply Voltage, 2.7V to 6V. V_{CC} should be bypassed appropriately with ceramic capacitors.

Exposed Pad (NA/Pin 7): Exposed Pad is GND. Must be soldered to PCB.

BLOCK DIAGRAM

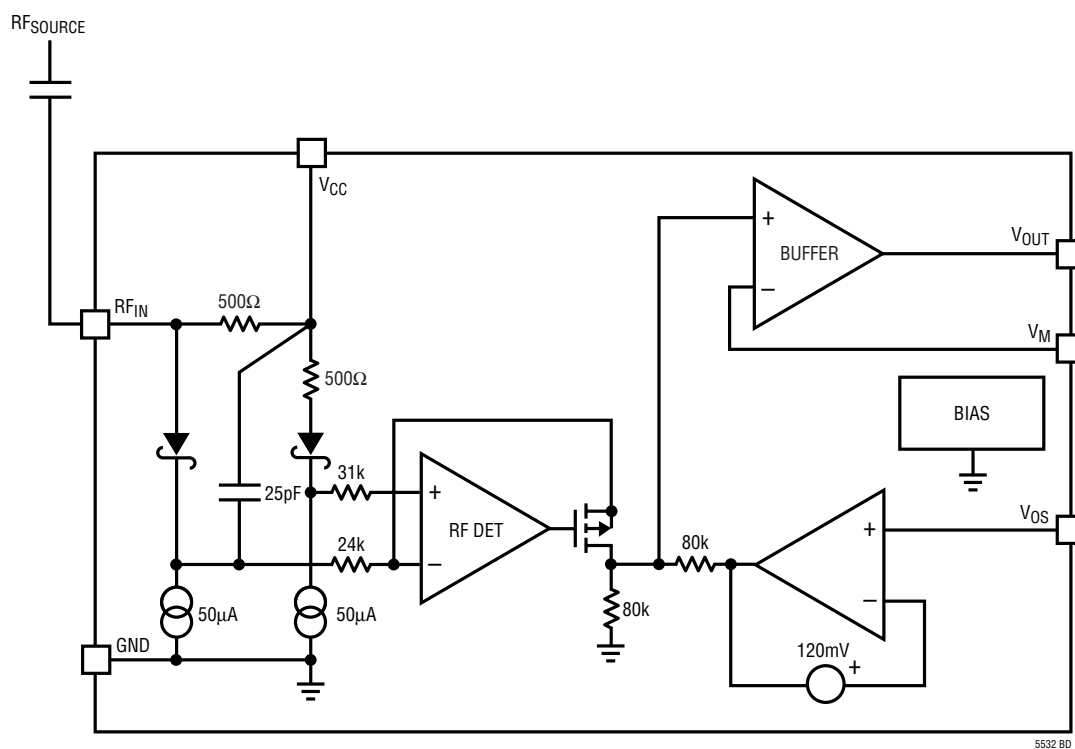

APPLICATIONS INFORMATION

Operation

The LTC5532 RF detector integrates several functions to provide RF power detection over frequencies ranging from 300MHz to 7GHz. These functions include an internal frequency compensated buffer amplifier, an RF Schottky diode peak detector and a level shift amplifier to convert the RF input signal to DC. The LTC5532 has both gain setting and voltage offset adjustment capabilities.

Buffer Amplifier

The output buffer amplifier is capable of supplying typically 4mA into a load. The negative terminal V_M is brought out to a pin for gain selection. External resistors connected between V_{OUT} and V_M (R_A) and V_M to ground (R_B) will set the gain of this amplifier.

$$\text{Gain} = 1 + R_A/R_B$$

The amplifier is unity gain stable; however a minimum gain of two is recommended to improve low output voltage accuracy. The amplifier has a bandwidth of 2MHz with a gain of 2. For increased gain applications, the bandwidth is reduced according to the formula:

$$\text{Bandwidth} = 4\text{MHz}/(\text{Gain}) = 4\text{MHz} \cdot R_B/(R_A + R_B)$$

A capacitor can be placed across the feedback resistor R_A to shape the frequency response. In addition, the amplifier can be used as a comparator. V_M can be connected to a reference voltage. When the internal detector output

voltage (which is connected to the positive input of the buffer amplifier) exceeds the external voltage on V_M , V_{OUT} will switch high.

The V_{OS} input controls the DC input voltage to the buffer amplifier. V_{OS} must be connected to ground if the DC starting voltage is not to be changed. The buffer is initially trimmed nominally to 120mV (Gain = 2x) with V_{OS} connected to ground.

The V_{OS} pin is used to change the initial V_{OUT} starting voltage. This function, in combination with gain adjustment enables the LTC5532 output to span the input range of a variety of analog-to-digital converters. V_{OUT} will not change until V_{OS} exceeds 120mV. The starting voltage at V_{OUT} for $V_{OS} > 120\text{mV}$ is:

$$V_{OUT} = 0.5 \cdot V_{OS} \cdot \text{Gain}$$

where gain is the output buffer gain. For a buffer gain of 2x, V_{OUT} will exactly track V_{OS} above 120mV.

RF Detector

The internal RF Schottky diode peak detector and level shift amplifier convert the RF input signal to a low frequency signal. The detector demonstrates excellent efficiency and linearity over a wide range of input power. The Schottky diode is biased at about 55 μA and drives a 25pF internal peak detector capacitor.

Demo Board Schematic

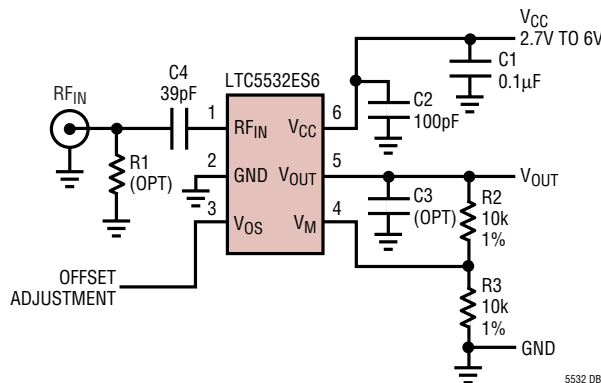

APPLICATIONS INFORMATION

Applications

The LTC5532 can be used as a self-standing signal strength measuring receiver for a wide range of input signals from -32dBm to 10dBm for frequencies from 300MHz to 7GHz . Operation at higher frequencies, to 12GHz or above, is achievable with reduced performance. The smaller DFN package version is recommended for these applications because of its lower parasitics. Figure 1 plots the output voltage as a function of RF power of a 12GHz CW input signal.

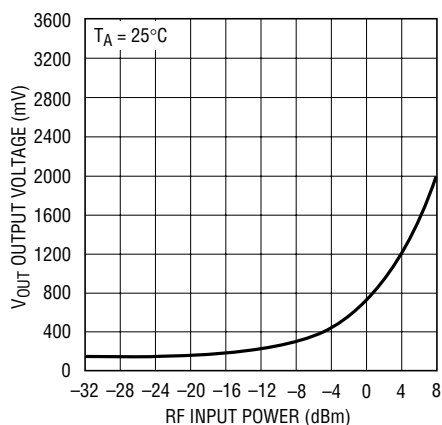

Figure 1. Typical Detector Characteristics, 12GHz , Gain = 2, $V_{OS} = 0\text{V}$ (DFN Package)

The LTC5532 can be used as a demodulator for AM and ASK modulated signals with data rates up to 2MHz . Depending on specific application needs, the RSSI output can be split between two branches, providing AC-coupled data (or audio) output and DC-coupled RSSI output for signal strength measurements and AGC.

The LTC5532 can be used for RF power detection and control. Figure 2 is an example of a transmitter power controller, using the LTC5532 with a capacitive tap to the power amplifier. A 0.5pF capacitor ($C1$) followed by a 200Ω resistor ($R1$) form a coupling circuit with about 20dB loss at 900MHz referenced to the LTC5532 RF input pin. In the actual product implementation, component values for the capacitive tap may be different depending on parts placement, PCB parasitics and parameters of the antenna.

The LTC5532 can be configured as a comparator for RF power detection and RF power alarms. The characterization data includes a plot of the LTC5532 output delay in response to a positive input step of varying RF level.

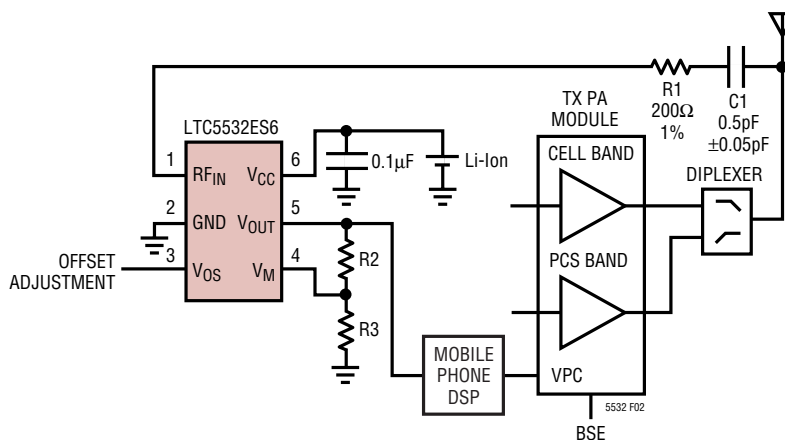
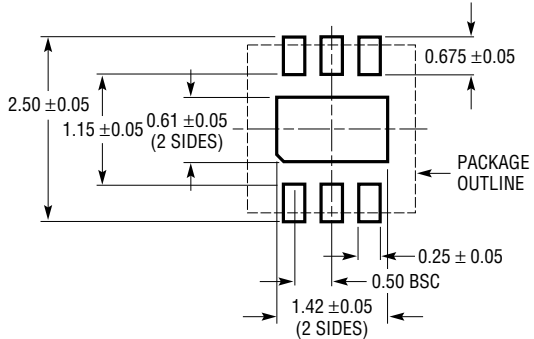

Figure 2. Mobile Phone Tx Power Control Application Diagram with a Capacitive Tap

PACKAGE DESCRIPTION

DC Package
6-Lead Plastic DFN (2mm × 2mm)
 (Reference LTC DWG # 05-08-1703)



RECOMMENDED SOLDER PAD PITCH AND DIMENSIONS

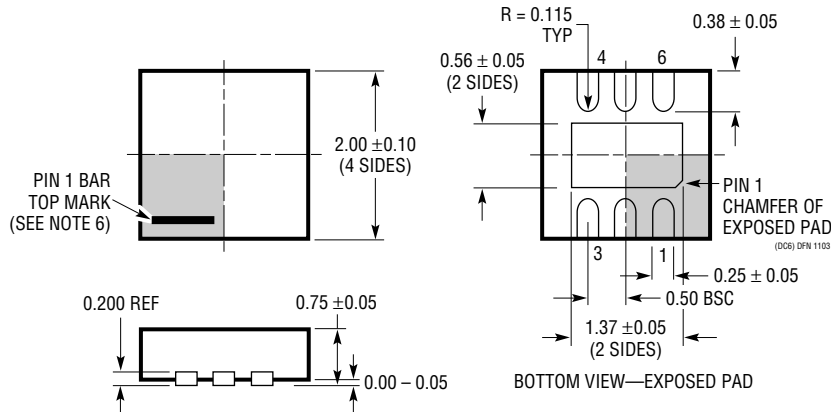

- NOTE:
1. DRAWING TO BE MADE A JEDEC PACKAGE OUTLINE M0-229 VARIATION OF (WCCD-2)
 2. DRAWING NOT TO SCALE
 3. ALL DIMENSIONS ARE IN MILLIMETERS
 4. DIMENSIONS OF EXPOSED PAD ON BOTTOM OF PACKAGE DO NOT INCLUDE MOLD FLASH. MOLD FLASH, IF PRESENT, SHALL NOT EXCEED 0.15mm ON ANY SIDE
 5. EXPOSED PAD SHALL BE SOLDER PLATED
 6. SHADED AREA IS ONLY A REFERENCE FOR PIN 1 LOCATION ON THE TOP AND BOTTOM OF PACKAGE

PACKAGE DESCRIPTION

S6 Package
6-Lead Plastic TSOT-23
 (Reference LTC DWG # 05-08-1636)

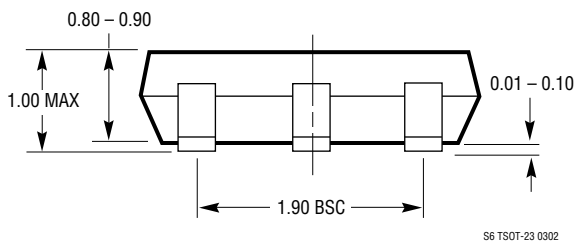
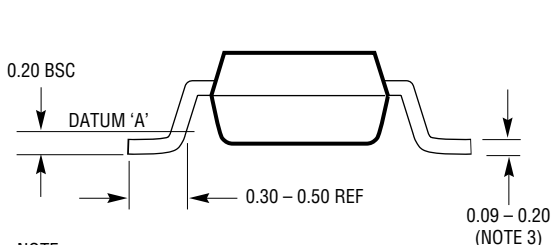
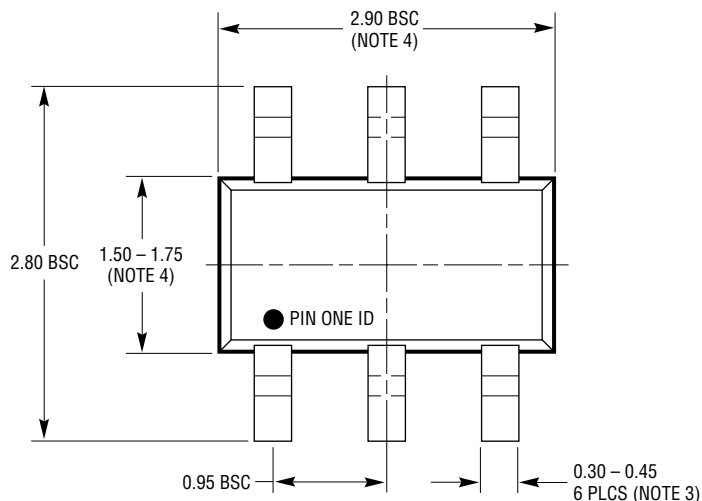
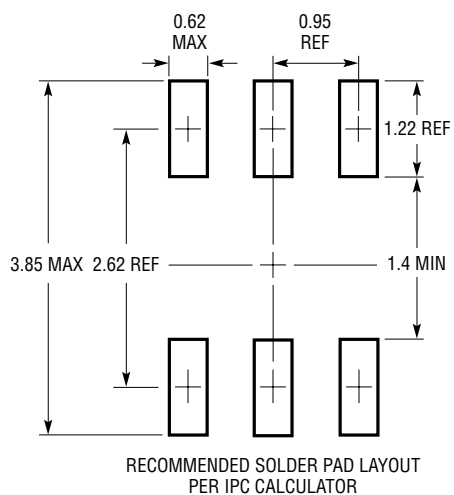

- NOTE:
1. DIMENSIONS ARE IN MILLIMETERS
 2. DRAWING NOT TO SCALE
 3. DIMENSIONS ARE INCLUSIVE OF PLATING
 4. DIMENSIONS ARE EXCLUSIVE OF MOLD FLASH AND METAL BURR
 5. MOLD FLASH SHALL NOT EXCEED 0.254mm
 6. JEDEC PACKAGE REFERENCE IS MO-193

RELATED PARTS

PART NUMBER	DESCRIPTION	COMMENTS
Infrastructure		
LT5511	High Linearity Upconverting Mixer	RF Output to 3GHz, 17dBm IIP3, Integrated LO Buffer
LT5512	DC-3GHz High Signal Level Downconverting Mixer	DC to 3GHz, 21dBm IIP3, Integrated LO Buffer
LT5515	1.5GHz to 2.5GHz Direct Conversion Quadrature Demodulator	20dBm IIP3, Integrated LO Quadrature Generator
LT5516	0.8GHz to 1.5GHz Direct Conversion Quadrature Demodulator	21.5dBm IIP3, Integrated LO Quadrature Generator
LT5517	40MHz to 900MHz Direct Conversion Quadrature Demodulator	21dBm IIP3, Integrated LO Quadrature Generator
LT5519	0.7GHz to 1.4GHz High Linearity Upconverting Mixer	17.1dBm IIP3, 50Ω Single Ended RF and LO Ports
LT5520	1.3GHz to 2.3GHz High Linearity Upconverting Mixer	15.9dBm IIP3, 50Ω Single Ended RF and LO Ports
LT5522	600MHz to 2.7GHz High Linearity Downconverting Mixer	4.5V to 5.25V Supply, 25dBm IIP3 at 900MHz, NF = 12.5dB, 50Ω Single-Ended RF and LO Ports
RF Power Detectors		
LT5504	800MHz to 2.7GHz RF Measuring Receiver	80dB Dynamic Range, Temperature Compensated, 2.7V to 5.25V Supply
LTC®5505	300MHz to 3GHz RF Power Detectors	LTC5505-1: -28dBm to 18dBm Range, LTC5505-2: -32dBm to 12dBm Range, Temperature Compensated, 2.7V to 6V Supply
LTC5507	100kHz to 1000MHz RF Power Detector	-34dBm to 14dBm Range, Temperature Compensated, 2.7V to 6V Supply
LTC5508	300MHz to 7GHz RF Power Detector	-32dBm to 12dBm Range, Temperature Compensated, SC70 Package
LTC5509	300MHz to 3GHz RF Power Detector	36dB Dynamic Range, Temperature Compensated, SC70 Package
LTC5530	Precision RF Detector with Shutdown and Gain Adjustment	300MHz to 7GHz, -32dBm to 10dBm Range
LTC5531	Precision RF Detector with Shutdown and Offset Adjustment	300MHz to 7GHz, -32dBm to 10dBm Range
RF Building Blocks		
LT5500	1.8GHz to 2.7GHz Receiver Front End	1.8V to 5.25V Supply, Dual-Gain LNA, Mixer, LO Buffer
LT5502	400MHz Quadrature IF Demodulator with RSSI	1.8V to 5.25V Supply, 70MHz to 400MHz IF, 84dB Limiting Gain, 90dB RSSI Range
LT5503	1.2GHz to 2.7GHz Direct IQ Modulator and Upconverting Mixer	1.8V to 5.25V Supply, Four-Step RF Power Control, 120MHz Modulation Bandwidth
LT5506	500MHz Quadrature IF Demodulator with VGA	1.8V to 5.25V Supply, 40MHz to 500MHz IF, -4dB to 57dB Linear Power Gain, 8.8MHz Baseband Bandwidth
LT5546	500MHz Quadrature IF Demodulator with VGA and 17MHz Baseband Bandwidth	17MHz Baseband Bandwidth, 40MHz to 500MHz IF, 1.8V to 5.25V Supply, -7dB to 56dB Linear Power Gain
RF Power Controllers		
LTC1757A	RF Power Controller	Multiband GSM/DCS/GPRS Mobile Phones
LTC1758	RF Power Controller	Multiband GSM/DCS/GPRS Mobile Phones
LTC1957	RF Power Controller	Multiband GSM/DCS/GPRS Mobile Phones
LTC4400	SOT-23 RF PA Controller	Multiband GSM/DCS/GPRS Phones, 45dB Dynamic Range, 450kHz Loop BW
LTC4401	SOT-23 RF PA Controller	Multiband GSM/DCS/GPRS Phones, 45dB Dynamic Range, 250kHz Loop BW
LTC4402	RF Power Controller for EDGE/TDMA	Multiband GSM/GPRS/EDGE Mobile Phones, 450kHz Loop BW
LTC4403	RF Power Controller for EDGE/TDMA	Multiband GSM/GPRS/EDGE Mobile Phones, 250kHz Loop BW