

Current Sensor : F01P***S05L



Features:

- Backward compatible to F01PS05 series
- Anti-Surge current (4kAT, 8/20uS, single)
- Mounting area reduced ; pin compatible. Longitudinal dimension reduced
- Super precision & High Stability (low temperature, drift)
- Unipolar power voltage ; +5V
- Multi-range models
- F01P***S05L series are designed by the pin compatibility as high-end models of S22P***X05M2 series.

Comparison of the main features of F*****S05L series

Series	Features
F01P***S05L	No reference access
F02P***S05L	No reference access. Ref In/Out
F03P***S05L	No reference access. Ref In/Out. Higher creep age and clearance distance.

*** = Rated Current Symbol

Specification

	F01P***S05L
Maximum Peak Current	4kAT (2kAx2. Number of primary turns is two turns)
Rated Current If (***= rated current symbol)	6A(006) / 15A(015) / 25A(025) 50A(050)
Maximum Current	±20A(If=6A) / ±51A(If=15A) / ±85A(If=25A) / ±150A(If=50A)
Existence of reference access	0
Number of primary busbar	3 pcs
Clearance distance ; Primary ↔ Secondary	7.7 mm
Standards	UL508 (file#E243511) , EN501758, EN61010-1 , EN60950-1
Ambient Operating Temperature	-40°C ~ +105°C

Mounting Area



The mounting area has been reduced more than the F01P series. However, F01P***S05L series are 100% compatible with original footprint mounting.

The F02P/F03PxxxS05L series also similarly reduces the mounting area.

Current Sensor : F01P***S05L

Absolute Maximum Rating

	Symbol	Unit	Value	Notes
Supply Voltage	Vcc	V	7	
Primary Conductor Temperature	-	°C	110	
ESD (HBM: Human Body Model)	-	kV	4	C=100pF , R=1.5kΩ
Maximum Peak Current	-	kAT	4	Current Waveform : <ul style="list-style-type: none"> • Front time 8μs • Time to half value 20μs • Single

Isolation Characteristics

	Symbol	Unit	Value	Notes
Insulation Voltage	Vd	-	AC4200V for 1 min. (Sensing Current 0.5mA)	Primary↔Secondary
Insulation Resistance	Ris	-	≥500mΩ (@DC500V)	Primary↔Secondary
Clearance distance	dCi	-	7.7mm (TYP)	Primary↔Secondary
Creep age distance	dCp	-	7.7mm (TYP)	Primary↔Secondary
Case material	-	-	UL94 V-0	
Comparative Tracking Index (CTI)	CTI	V	600	
Application Example	-	-	300V , CAT III , PD2	Reinforced Isolation Non uniform field according to EN50178 , EN61010
	-	-	600V , CAT III , PD2	Simple isolation Non uniform field according to EN50178 , EN61010

Environmental and Mechanical Characteristics

	Symbol	Unit	Value		
			min	typ	max
Ambient Operating Temperature	Ta	°C	- 40		+ 105
Ambient Storage Temperature	Ts	°C	- 40		+105
Mass	-	g		12	

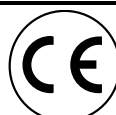

Current Sensor : F01P***S05L

Specification

(*1) = Offset voltage value is after removal of core hysteresis

		Symbol	Unit	Value			Notes
				min	typ	max	
Rated Current	F01P006S05L	If	A		6		
	F01P015S05L				15		
	F01P025S05L				25		
	F01P050S05L				50		
Maximum Current (@ Vcc : +5V , Ta : +105°C)	F01P006S05L	Ipmax	A	- 20		20	
	F01P015S05L			- 51		51	
	F01P025S05L			- 85		85	
	F01P050S05L			- 150		150	
Supply Voltage		Vcc	V	4.75	5.00	5.25	
Number of primary turns		Np	T	1,2,3			
Number of secondary turns	F01P006S05L	Ns	T		1816		
	F01P015S05L				1737		
	F01P025S05L				1764		
	F01P050S05L				1600		
Consumption current (at If)	F01P006S05L	Icc	mA		25		Icc=15+Ip(mA) / Ns
	F01P015S05L				30		
	F01P025S05L				35		
	F01P050S05L				55		
Output Voltage		Vo	V	0.375		4.625	
Output Voltage (Ip=0A)		Vo	V		2.5		
Electrical Offset Voltage (*1)	F01P006S05L	Voe	mV	- 10.40		10.40	
	F01P015S05L			- 7.10		7.10	
	F01P025S05L			- 6.25		6.25	
	F01P050S05L			- 5.80		5.80	
Electrical Offset Current referred to primary	F01P006S05L	loe	A	- 0.10		0.10	
	F01P015S05L			- 0.17		0.17	
	F01P025S05L			- 0.25		0.25	
	F01P050S05L			- 0.46		0.46	

Current Sensor : F01P***S05L

Specification

		Symbol	Unit	Value			Notes
				min	typ	max	
Temperature coefficient of Output voltage (@ Ip=0A)	F01P006S05L	TCVo	ppm/K		±10.0	±80.0	ppm/K of 2.5V (-40°C~+105°C)
	F01P015S05L				±7.5	±70.0	
	F01P025S05L				±6.5	±60.0	
	F01P050S05L				±6.0	±60.0	
Sensitivity (Theoretical value)	F01P006S05L	Gth	mV/A		104.2		625mV/If
	F01P015S05L				41.67		
	F01P025S05L				25		
	F01P050S05L				12.5		
Sensitivity Error		ϵ_G	%	- 0.7		0.7	
Temperature coefficient of Sensitivity (@Ta=-40°C~+105°C)		TCG	ppm/K			±40	
Output Linearity		ϵ_L	%	- 0.1		0.1	
Magnetic offset current referred to primary (@ 10xf)		Iom	A	- 0.1		0.1	
Output current noise referred to primary (@ 100Hz~100kHz)	F01P006S05L	Ino	$\mu\text{A}/(\text{Hz})^{1/2}$		36		RL=1k Ω
	F01P015S05L				90		
	F01P025S05L				150		
	F01P050S05L				300		
Peak to peak output ripple at oscillator frequency (f typ=450kHz)	F01P006S05L	-	mV		40	160	RL=1k Ω
	F01P015S05L				15	60	
	F01P025S05L				10	40	
	F01P050S05L				5	20	
Reaction time (@ 10% of If)	F01P006S05L	tra	μs			0.3	RL=1k Ω , di/dt=18A/ μs
	F01P015S05L					0.3	RL=1k Ω , di/dt=44A/ μs
	F01P025S05L					0.3	RL=1k Ω , di/dt=68A/ μs
	F01P050S05L					0.3	RL=1k Ω , di/dt=100/ μs
Response time (@90% of If)	F01P006S05L	tr	μs			0.3	RL=1k Ω , di/dt=18A/ μs
	F01P015S05L					0.3	RL=1k Ω , di/dt=44A/ μs
	F01P025S05L					0.3	RL=1k Ω , di/dt=68A/ μs
	F01P050S05L					0.3	RL=1k Ω , di/dt=100/ μs

Current Sensor : F01P***S05L

Specification

		Symbol	Unit	Value			Comment
				min	typ	max	
Response time 2 (@ 10% of I_f to 90% of V_o)		t_r	μs			0.6	$R_L=1k\Omega$
Frequency bandwidth ($\pm 1dB$)		BW	kHz	200			$R_L=1k\Omega$
Frequency bandwidth ($\pm 3dB$)		BW	kHz	300			$R_L=1k\Omega$
Output Voltage Accuracy (Overall)	F01P006S05L	X_G	%			2.5	$X_G=(100 \times V_{oe}/625)+\epsilon_G+\epsilon_L$
	F01P015S05L					1.9	
	F01P025S05L					1.8	
	F01P050S05L					1.7	

Standards

EN 50178; EN 61010-1 ; EN 60950-1 ; UL 508 (file no. E243511)

Characteristic Curve (TYP)



Figure 1: Linearity curve



Figure 2: Frequency response curve

ex) F01P025S05L

Measurement condition $T_a=+25^\circ C$, $R_L=1k\Omega$, $I_p=3A$, $V_{cc}=+5V$

Current Sensor : F01P***S05L

Maximum Continuous DC primary current

According to which the following conditions are true the maximum continuous DC primary current plot shows the boundary of the area.

1. $I_p < I_{pmax}$
2. Junction temperature $T_j < 125^\circ\text{C}$
3. Primary conductor temperature $< 110^\circ\text{C}$
4. Resistor power dissipation $< 0.5 \times \text{rated power}$

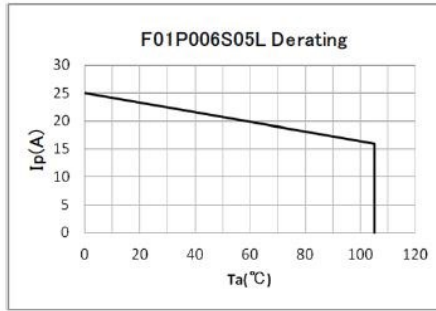

Figure 3: Ip vs Ta for F01P006S05L

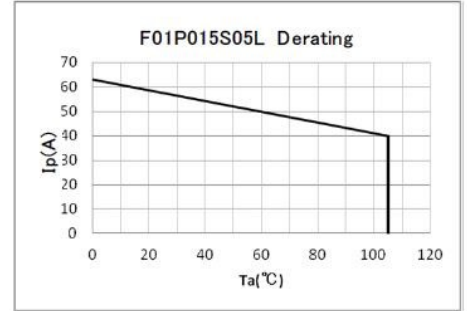

Figure 4: Ip vs Ta for F01P015S05L

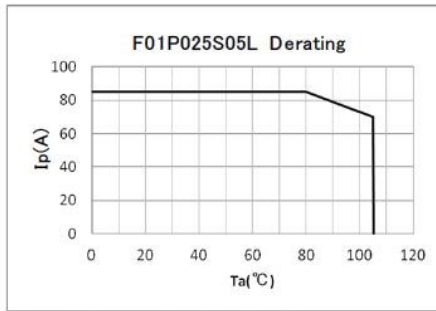

Figure 5: Ip vs Ta for F01P025S05L

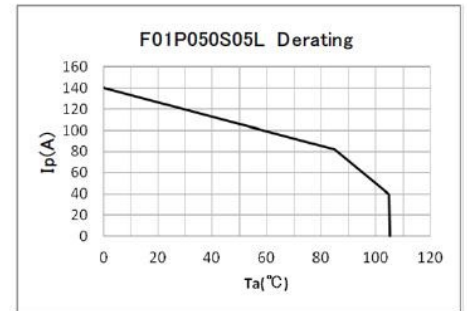

Figure 6: Ip vs Ta for F01P050S05L

Frequency Derating



Figure 7 : Maximum RMS AC primary current / maximum DC primary current vs frequency

Current Sensor : F01P***S05L

Connection



Dimension (mm)

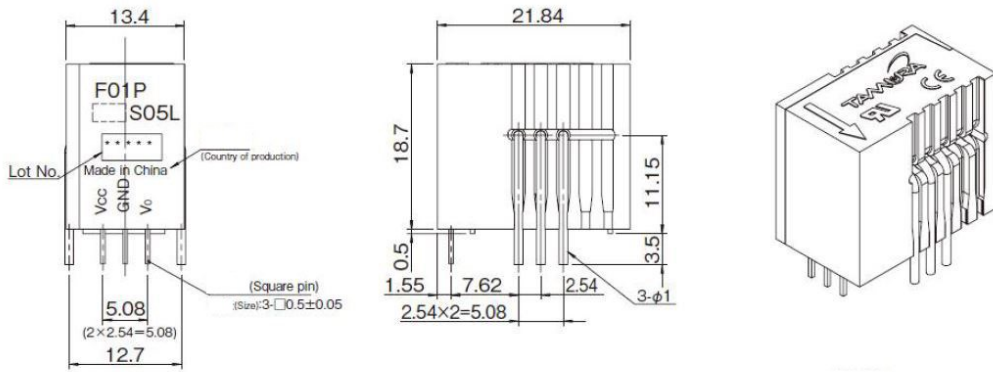

Terminal number	
① Input	⑧ Output
② Input	⑨ Output
③ Input	⑩ Output
④ -	⑪ V _o
⑤ -	⑫ GND
⑥ -	⑬ V _{cc}
⑦ -	

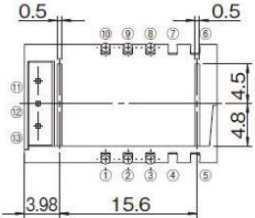

Note

1. Unless otherwise specified, tolerances shall be $\pm 0.25\text{mm}$
2. Unit is [mm]

Recommended Hole Diameter (mm)

