

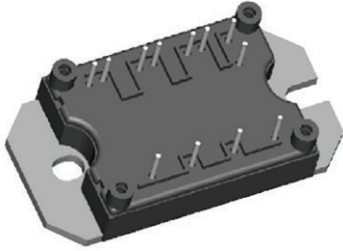

“Half Bridge” IGBT MTP (Warp 2 Speed IGBT), 70 A

MTP

RoHS
COMPLIANT

FEATURES

- NPT warp 2 speed IGBT technology with positive temperature coefficient
- HEXFRED® antiparallel diodes with ultrasoft reverse recovery
- SMD thermistor (NTC)
- Al₂O₃ BDC
- Very low stray inductance design for high speed operation
- UL pending
- Speed 60 kHz to 150 kHz
- UL approved file E78996 
- Designed and qualified for industrial level
- Material categorization: For definitions of compliance please see www.vishay.com/doc?99912

BENEFITS

- Optimized for welding, UPS and SMPS applications
- Lower conduction losses and switching losses
- Low EMI, requires less snubbing
- Direct mounting to heatsink
- PCB solderable terminals

PRODUCT SUMMARY	
V _{CES}	600 V
V _{CE(on)} typical at V _{GE} = 15 V	2.1 V
I _C at T _C = 78 °C	70 A
Package	MTP
Circuit	Half bridge

ABSOLUTE MAXIMUM RATINGS				
PARAMETER	SYMBOL	TEST CONDITIONS	MAX.	UNITS
Collector to emitter voltage	V _{CES}		600	V
Continuous collector current	I _C	T _C = 25 °C	100	A
		T _C = 78 °C	70	
Pulsed collector current	I _{CM}		300	
Peak switching current	I _{LM}		300	
Diode continuous forward current	I _F	T _C = 78 °C	53	
Peak diode forward current	I _{FM}		200	
Gate to emitter voltage	V _{GE}		± 20	V
RMS isolation voltage	V _{ISOL}	Any terminal to case, t = 1 min	2500	
Maximum power dissipation, IGBT	P _D	T _C = 25 °C	347	W
		T _C = 100 °C	139	



ELECTRICAL SPECIFICATIONS ($T_J = 25\text{ }^\circ\text{C}$ unless otherwise specified)						
PARAMETER	SYMBOL	TEST CONDITIONS	MIN.	TYP.	MAX.	UNITS
Collector to emitter breakdown voltage	$V_{(BR)CES}$	$V_{GE} = 0\text{ V}, I_C = 500\text{ }\mu\text{A}$	600	-	-	V
Collector to emitter voltage	$V_{CE(on)}$	$V_{GE} = 15\text{ V}, I_C = 70\text{ A}$	-	2.1	2.4	V
		$V_{GE} = 15\text{ V}, I_C = 140\text{ A}$	-	2.8	3.4	
		$V_{GE} = 15\text{ V}, I_C = 70\text{ A}, T_J = 150\text{ }^\circ\text{C}$	-	2.7	3	
Gate threshold voltage	$V_{GE(th)}$	$I_C = 0.5\text{ mA}$	3	-	6	
Collector to emitter leaking current	I_{CES}	$V_{GE} = 0\text{ V}, I_C = 600\text{ V}$	-	-	0.7	mA
		$V_{GE} = 0\text{ V}, I_C = 600\text{ V}, T_J = 150\text{ }^\circ\text{C}$	-	-	10	
Gate to emitter leakage current	I_{GES}	$V_{GE} = \pm 20\text{ V}$	-	-	± 250	nA

SWITCHING CHARACTERISTICS ($T_J = 25\text{ }^\circ\text{C}$ unless otherwise specified)						
PARAMETER	SYMBOL	TEST CONDITIONS	MIN.	TYP.	MAX.	UNITS
Total gate charge (turn-on)	Q_g	$I_C = 70\text{ A}$ $V_{CC} = 480\text{ V}$ $V_{GE} = 15\text{ V}$	-	460	690	nC
Gate to emitter charge (turn-on)	Q_{ge}		-	160	250	
Gate to collector charge (turn-on)	Q_{gc}		-	70	130	
Turn-on switching loss	E_{on}	$R_g = 10\text{ }\Omega$	-	1.1	-	mJ
Turn-off switching loss	E_{off}	$I_C = 70\text{ A}, V_{CC} = 480\text{ V}, V_{GE} = 15\text{ V}, L = 200\text{ }\mu\text{H}$ Energy losses include tail and diode reverse recovery, $T_J = 25\text{ }^\circ\text{C}$	-	0.9	-	
Total switching loss	E_{ts}	-	-	2	-	
Turn-on switching loss	E_{on}	$R_g = 10\text{ }\Omega$	-	1.27	-	
Turn-off switching loss	E_{off}	$I_C = 70\text{ A}, V_{CC} = 480\text{ V}, V_{GE} = 15\text{ V}, L = 200\text{ }\mu\text{H}$ Energy losses include tail and diode reverse recovery, $T_J = 150\text{ }^\circ\text{C}$	-	1.13	-	
Total switching loss	E_{ts}	-	-	2.4	-	
Turn-on delay time	td_{on}	$R_g = 10\text{ }\Omega$ $I_C = 70\text{ A}, V_{CC} = 480\text{ V}, V_{GE} = 15\text{ V}, L = 200\text{ }\mu\text{H}$ Energy losses include tail and diode reverse recovery	-	314	-	ns
Rise time	t_r		-	49	-	
Turn-off delay time	td_{off}		-	308	-	
Fail time	t_f		-	68	-	
Turn-on delay time	td_{on}	$R_g = 10\text{ }\Omega$ $I_C = 70\text{ A}, V_{CC} = 480\text{ V}, V_{GE} = 15\text{ V}, L = 200\text{ }\mu\text{H}$ Energy losses include tail and diode reverse recovery, $T_J = 150\text{ }^\circ\text{C}$	-	312	-	ns
Rise time	t_r		-	50	-	
Turn-off delay time	td_{off}		-	320	-	
Fail time	t_f		-	78	-	
Input capacitance	C_{ies}	$V_{GE} = 0\text{ V}$ $V_{CC} = 30\text{ V}$ $f = 1.0\text{ MHz}$	-	8000	-	pF
Output capacitance	C_{oes}		-	790	-	
Reverse transfer capacitance	C_{res}		-	110	-	
Reverse BIAS safe operating area	RBSOA	$T_J = 150\text{ }^\circ\text{C}, I_C = 300\text{ A}$ $V_{CC} = 400\text{ V}, V_P = 600\text{ V}$ $R_g = 22\text{ }\Omega, V_{GE} = +15\text{ V to }0\text{ V}$	Fullsquare			



THERMISTOR SPECIFICATIONS						
PARAMETER	SYMBOL	TEST CONDITIONS	MIN.	TYP.	MAX.	UNITS
Resistance	R_0 ⁽¹⁾	$T_0 = 25\text{ }^\circ\text{C}$	-	30	-	$k\Omega$
Sensitivity index of the thermistor material	β ⁽¹⁾⁽²⁾	$T_0 = 25\text{ }^\circ\text{C}$ $T_1 = 85\text{ }^\circ\text{C}$	-	4000	-	K

Notes

(1) T_0, T_1 are thermistor's temperatures

(2) $\frac{R_0}{R_1} = \exp\left[\beta\left(\frac{1}{T_0} - \frac{1}{T_1}\right)\right]$, temperature in Kelvin

DIODE SPECIFICATIONS ($T_J = 25\text{ }^\circ\text{C}$ unless otherwise specified)						
PARAMETER	SYMBOL	TEST CONDITIONS	MIN.	TYP.	MAX.	UNITS
Diode forward voltage drop	V_{FM}	$I_C = 70\text{ A}, V_{GE} = 0\text{ V}$	-	1.64	2.1	V
		$I_C = 140\text{ A}, V_{GE} = 0\text{ V}$	-	2.1	2.4	
		$I_C = 70\text{ A}, V_{GE} = 0\text{ V}, T_J = 150\text{ }^\circ\text{C}$	-	1.69	1.9	
Diode reverse recovery time	t_{rr}	$V_{CC} = 200\text{ V}, I_C = 70\text{ A}$ $di/dt = 200\text{ A}/\mu\text{s}$	-	96	126	ns
Diode peak reverse current	I_{rr}		-	9.4	12.8	A
Diode recovery charge	Q_{rr}		-	440	750	nC
Diode reverse recovery time	t_{rr}	$V_{CC} = 200\text{ V}, I_C = 70\text{ A}$ $di/dt = 200\text{ A}/\mu\text{s}$ $T_J = 125\text{ }^\circ\text{C}$	-	140	194	ns
Diode peak reverse current	I_{rr}		-	14	19	A
Diode recovery charge	Q_{rr}		-	950	1700	nC

THERMAL AND MECHANICAL SPECIFICATIONS						
PARAMETER	SYMBOL	TEST CONDITIONS	MIN.	TYP.	MAX.	UNITS
Operating junction temperature range	IGBT, Diode	T_J	- 40	-	150	$^\circ\text{C}$
	Thermistor		- 40	-	125	
Storage temperature range	T_{Stg}		- 40	-	125	
Junction to case	IGBT	R_{thJC}	-	-	0.36	$^\circ\text{C}/\text{W}$
	Diode		-	-	0.8	
Case to sink per module	R_{thCS}	Heatsink compound thermal conductivity = 1 W/mK	-	0.06	-	
Mounting torque to heatsink		A mounting compound is recommended and the torque should be checked after 3 hours to allow for the spread of the compound. Lubricated threads.	3 ± 10 %			Nm
Weight			66			g

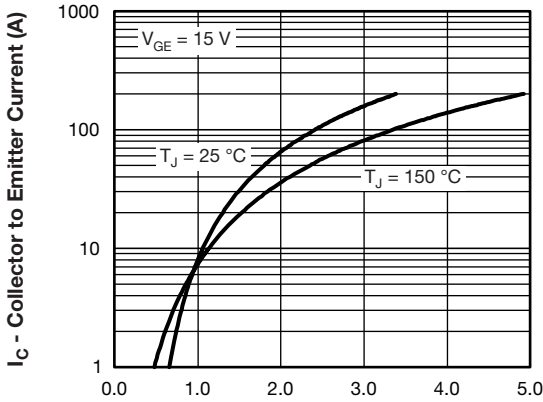

94469_01 **V_{CE} - Collector to Emitter Voltage (V)**
Fig. 1 - Typical Output Characteristics

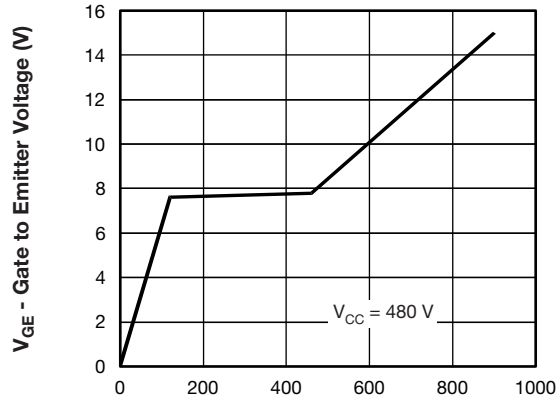

94469_04 **O_G - Total Gate Charge (nC)**
Fig. 4 - Typical Gate Charge vs. Gate to Emitter Voltage

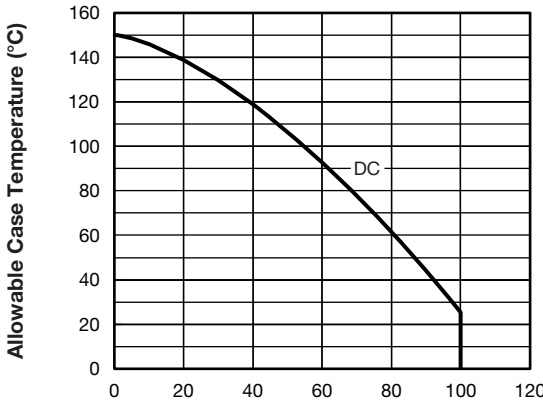

94469_02 **Maximum DC Collector Current (A)**
Fig. 2 - Maximum Collector Current vs. Case Temperature

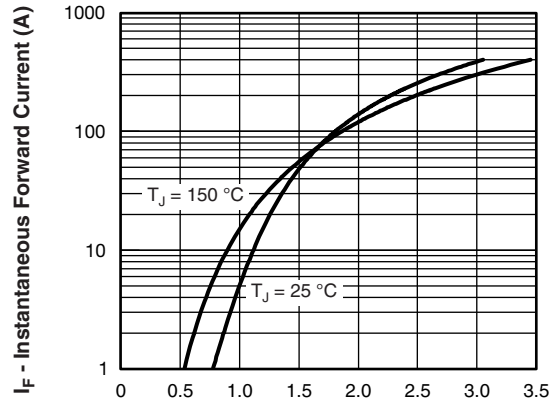

94469_05 **V_{FM} - Forward Voltage Drop (V)**
Fig. 5 - Maximum Forward Voltage Drop vs. Instantaneous Forward Current

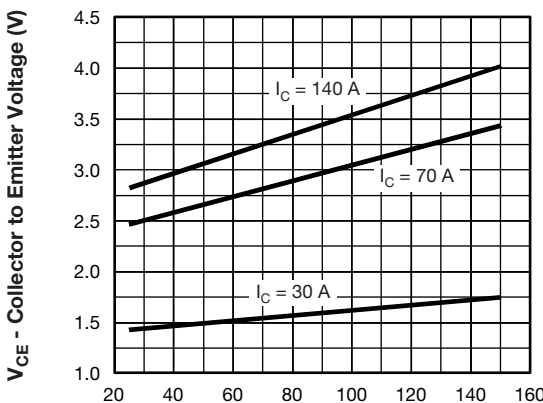

94469_03 **T_J - Junction Temperature (°C)**
Fig. 3 - Typical Collector to Emitter Voltage vs. Junction Temperature

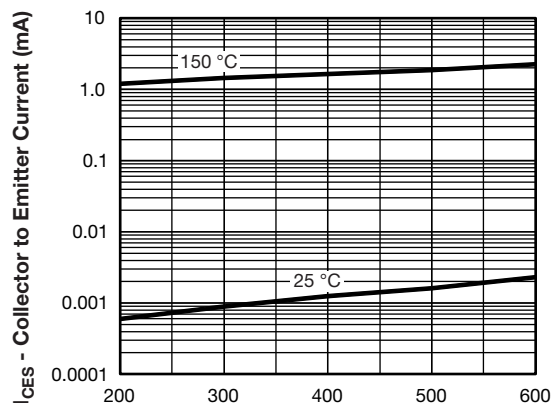

94469_06 **V_{CES} - Collector to Emitter Voltage (V)**
Fig. 6 - Typical Zero Gate Voltage Collector Current

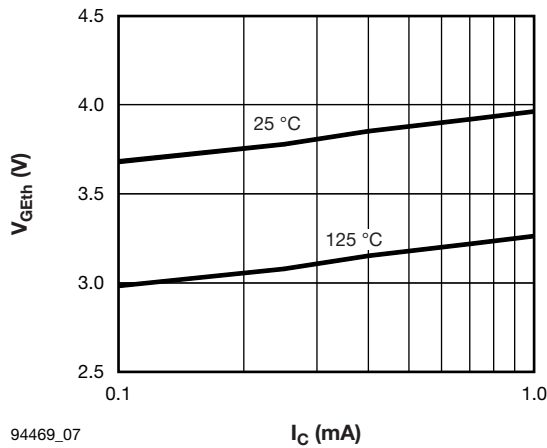

94469_07

Fig. 7 - Typical Gate Threshold Voltage

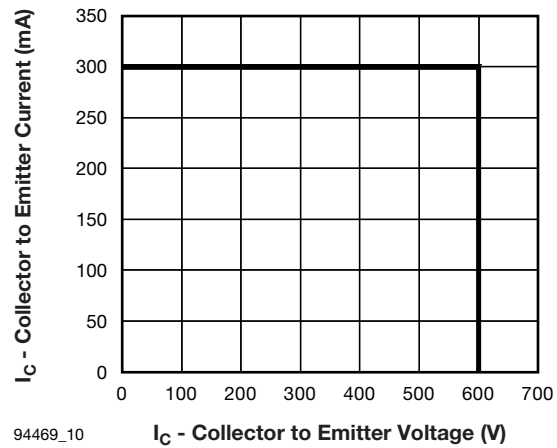

94469_10

Fig. 10 - Reverse BIAS SOA, $T_J = 150\text{ °C}$

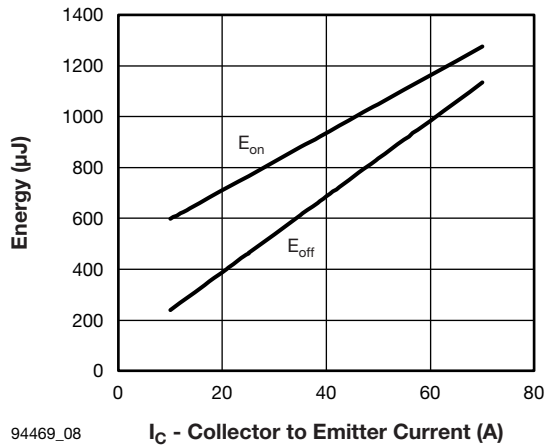

94469_08

Fig. 8 - Typical Energy Losses vs. I_C ($T_J = 150\text{ °C}$)

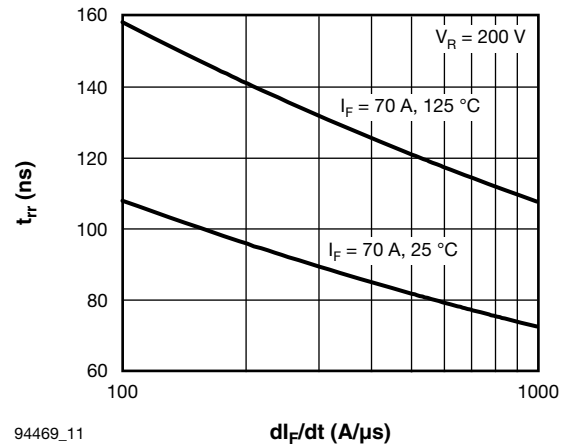

94469_11

Fig. 11 - Typical Reverse Recovery Time vs. di_F/dt

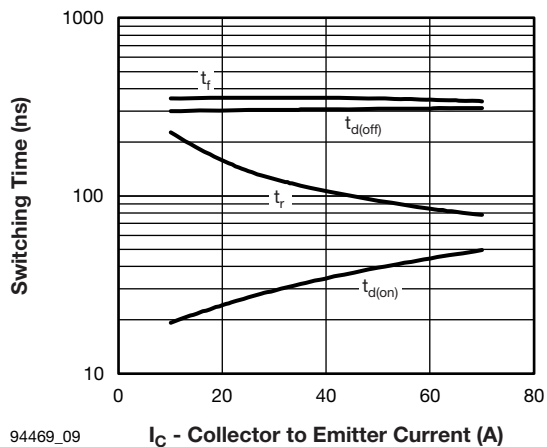

94469_09

Fig. 9 - Switching Time vs. I_C

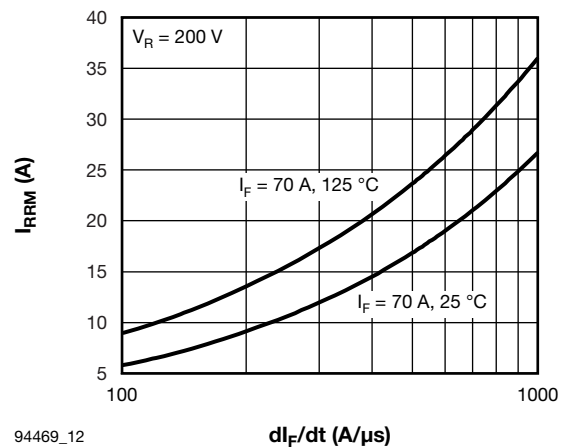

94469_12

Fig. 12 - Typical Reverse Recovery Current vs. di_F/dt

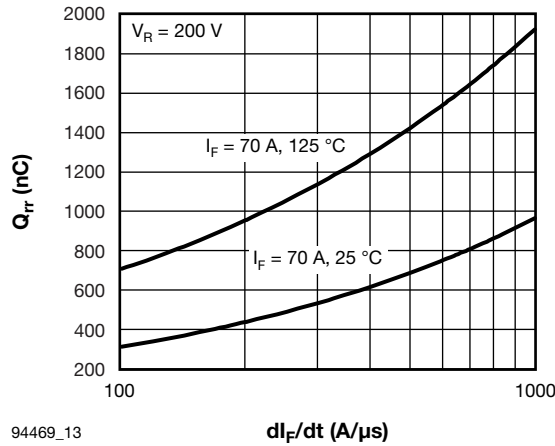

94469_13

Fig. 13 - Typical Stored Charge vs. di_F/dt

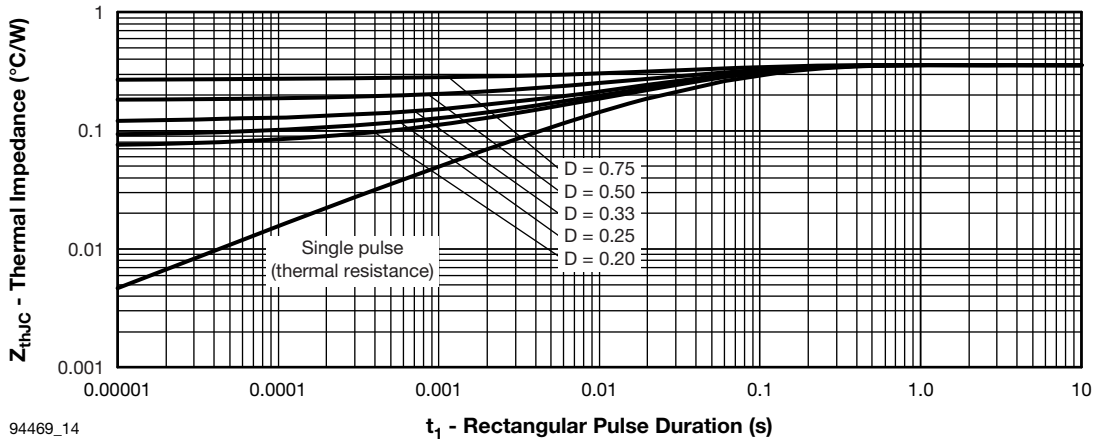

94469_14

Fig. 14 - Maximum Thermal Impedance Z_{thJC} Characteristics (IGBT)

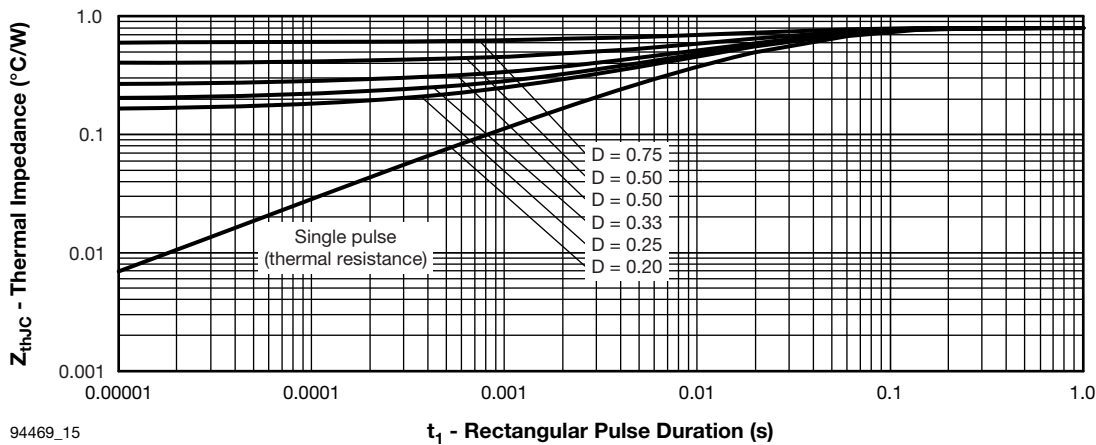

94469_15

Fig. 15 - Maximum Thermal Impedance Z_{thJC} Characteristics (Diode)

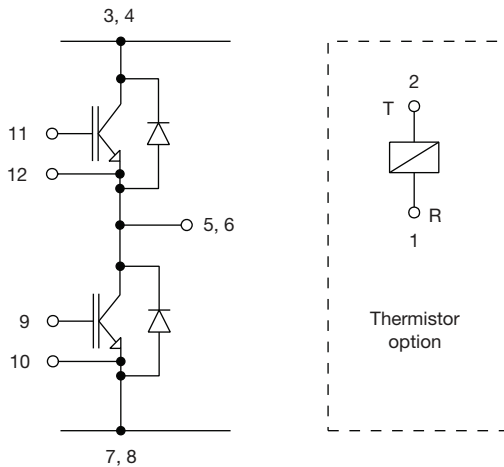

Fig. 16 - Electrical Diagram

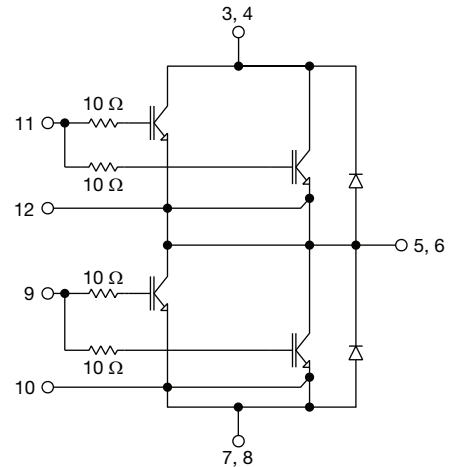
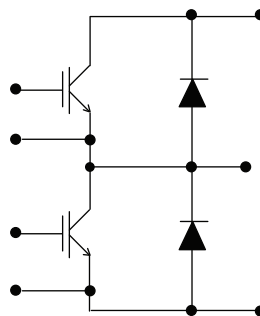

Fig. 17 - Functional Diagram

ORDERING INFORMATION TABLE

Device code	VS-	70	MT	060	W	H	T	A	PbF
	①	②	③	④	⑤	⑥	⑦	⑧	⑨
1	-	2	-	3	-	4	-	5	-
2	-	70	-	60	-	H	-	A	-
3	-		-	060	-	T	-		-
4	-		-		-		-		-
5	-		-		-		-		-
6	-		-		-		-		-
7	-		-		-		-		-
8	-		-		-		-		-
9	-		-		-		-		-

- 1** - Vishay Semiconductors product
- 2** - Current rating (70 = 70 A)
- 3** - Essential part number
- 4** - Voltage rating (060 = 600 V)
- 5** - Speed/type (W = Warp IGBT)
- 6** - Circuit configuration (H = Half bridge)
- 7** - T = Thermistor
- 8** - A = Al₂O₃ DBC substrate
- 9** - Lead (Pb)-free

CIRCUIT CONFIGURATION

LINKS TO RELATED DOCUMENTS	
Dimensions	www.vishay.com/doc?95175

MTP

DIMENSIONS in millimeters

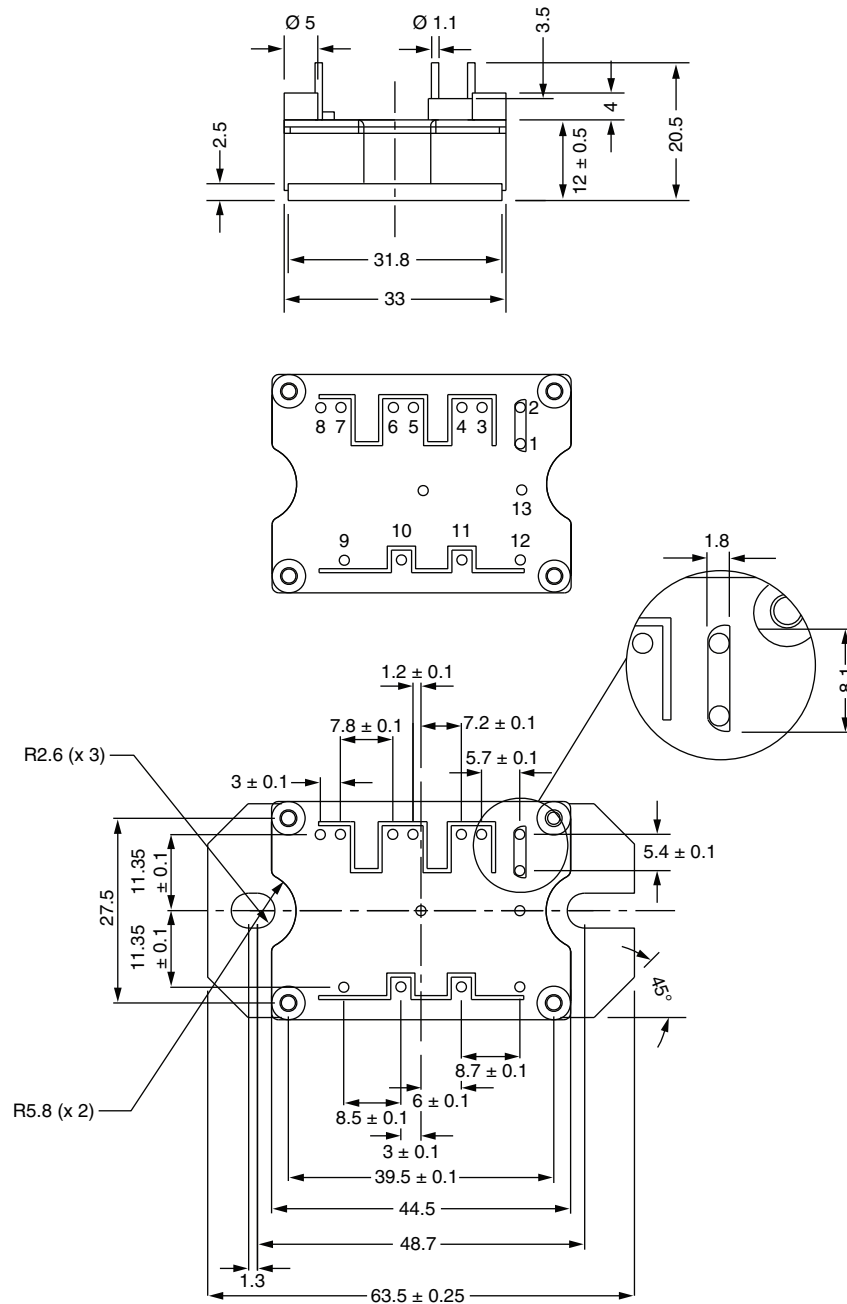

Note

- Unused terminals are not assembled in the package



Disclaimer

ALL PRODUCT, PRODUCT SPECIFICATIONS AND DATA ARE SUBJECT TO CHANGE WITHOUT NOTICE TO IMPROVE RELIABILITY, FUNCTION OR DESIGN OR OTHERWISE.

Vishay Intertechnology, Inc., its affiliates, agents, and employees, and all persons acting on its or their behalf (collectively, "Vishay"), disclaim any and all liability for any errors, inaccuracies or incompleteness contained in any datasheet or in any other disclosure relating to any product.

Vishay makes no warranty, representation or guarantee regarding the suitability of the products for any particular purpose or the continuing production of any product. To the maximum extent permitted by applicable law, Vishay disclaims (i) any and all liability arising out of the application or use of any product, (ii) any and all liability, including without limitation special, consequential or incidental damages, and (iii) any and all implied warranties, including warranties of fitness for particular purpose, non-infringement and merchantability.

Statements regarding the suitability of products for certain types of applications are based on Vishay's knowledge of typical requirements that are often placed on Vishay products in generic applications. Such statements are not binding statements about the suitability of products for a particular application. It is the customer's responsibility to validate that a particular product with the properties described in the product specification is suitable for use in a particular application. Parameters provided in datasheets and/or specifications may vary in different applications and performance may vary over time. All operating parameters, including typical parameters, must be validated for each customer application by the customer's technical experts. Product specifications do not expand or otherwise modify Vishay's terms and conditions of purchase, including but not limited to the warranty expressed therein.

Except as expressly indicated in writing, Vishay products are not designed for use in medical, life-saving, or life-sustaining applications or for any other application in which the failure of the Vishay product could result in personal injury or death. Customers using or selling Vishay products not expressly indicated for use in such applications do so at their own risk. Please contact authorized Vishay personnel to obtain written terms and conditions regarding products designed for such applications.

No license, express or implied, by estoppel or otherwise, to any intellectual property rights is granted by this document or by any conduct of Vishay. Product names and markings noted herein may be trademarks of their respective owners.

Material Category Policy

Vishay Intertechnology, Inc. hereby certifies that all its products that are identified as RoHS-Compliant fulfill the definitions and restrictions defined under Directive 2011/65/EU of The European Parliament and of the Council of June 8, 2011 on the restriction of the use of certain hazardous substances in electrical and electronic equipment (EEE) - recast, unless otherwise specified as non-compliant.

Please note that some Vishay documentation may still make reference to RoHS Directive 2002/95/EC. We confirm that all the products identified as being compliant to Directive 2002/95/EC conform to Directive 2011/65/EU.

Vishay Intertechnology, Inc. hereby certifies that all its products that are identified as Halogen-Free follow Halogen-Free requirements as per JEDEC JS709A standards. Please note that some Vishay documentation may still make reference to the IEC 61249-2-21 definition. We confirm that all the products identified as being compliant to IEC 61249-2-21 conform to JEDEC JS709A standards.