

Frontplattenausschnitt (Frontseite)
Panel cut out (front side)

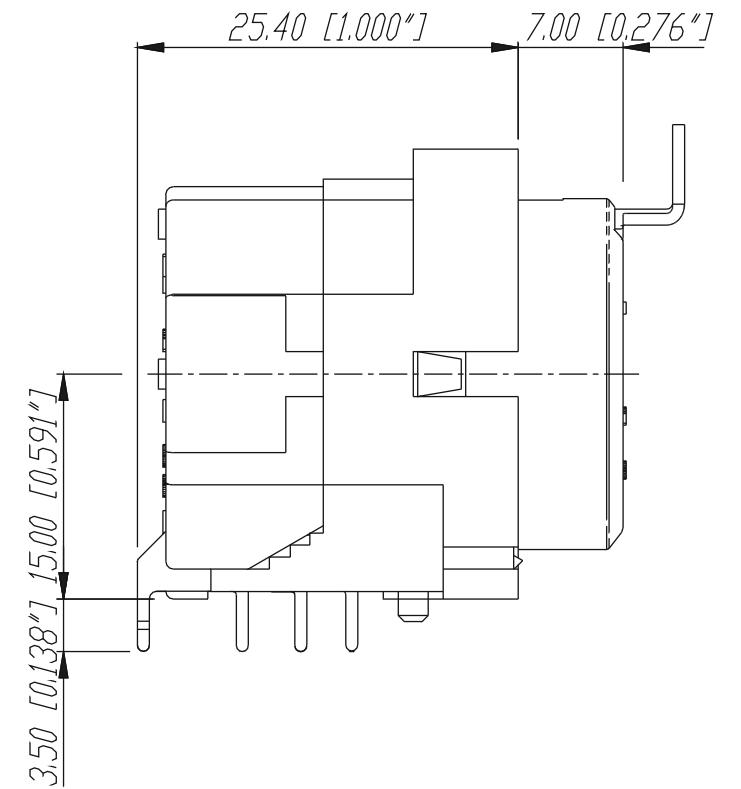

Print-Bohrplan (Bestueckungsseite)
PCB-Layout (component side)

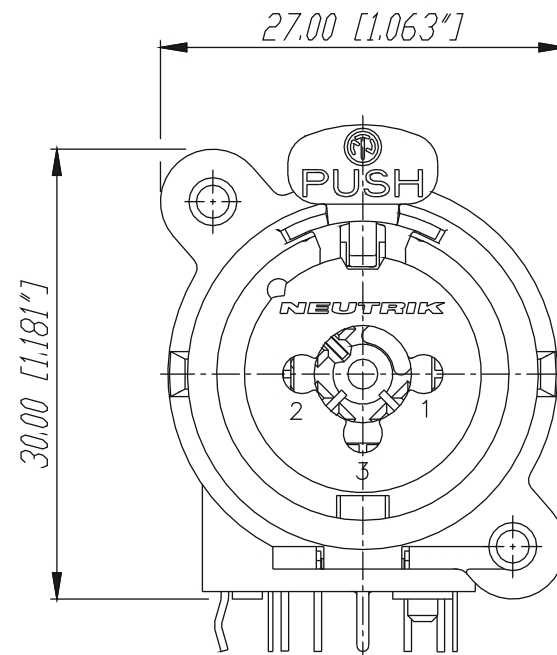
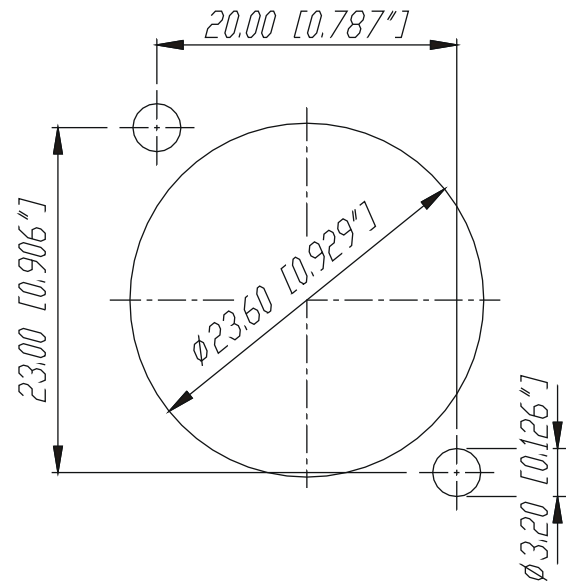
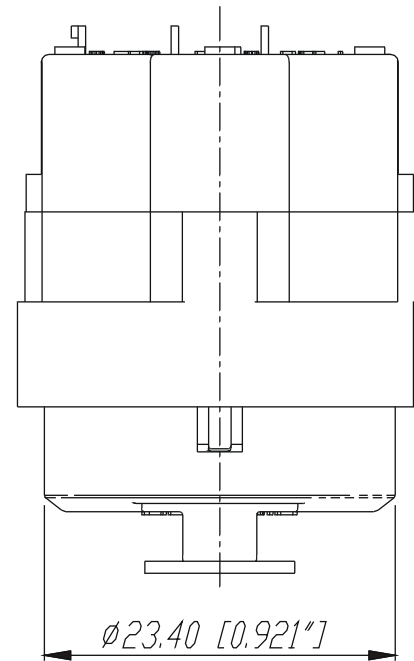
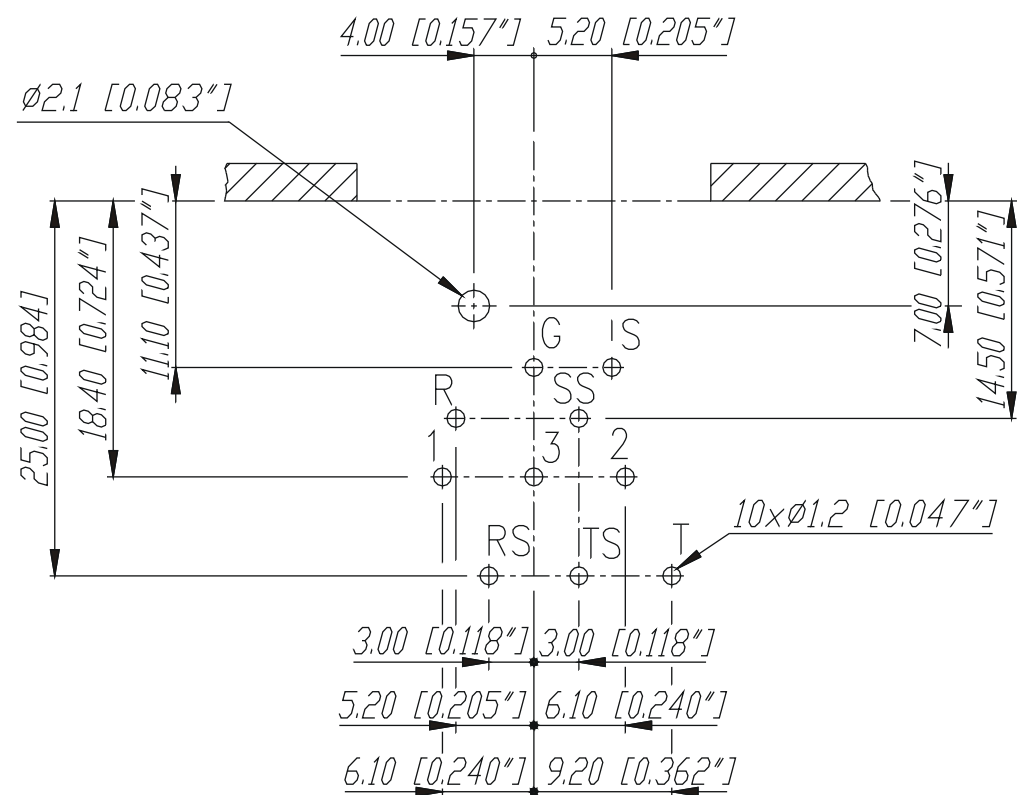

				Werkstoff:	Massstab:	Datum	Name
*)Lieferant darf ohne Rucksprache nicht geandert werden					2:1	25.05.98	Dobler
Zeichnung urheberrechtlich geschuetzt (DIN 34) (C)							
Benennung:				NCJ9FI-H		Ersetzt durch: Blatt	
						Ersatz fuer: von Blatt	
B	Teardrop	26.10.98	Dobler	NEUTRIK AG FL-9494 SCHAAN		Zeichn. Nr. 3102 St 17 12	
A	1.2 (0.047")	07.07.98	Dobler				
Ind.	Aenderung	Datum	Name				

The new **Combo** Combined **XLR Receptacle and Phone Jack**

Circuits:

- 5 -

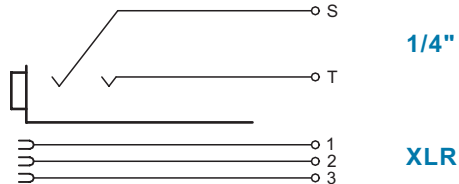

- 6 -

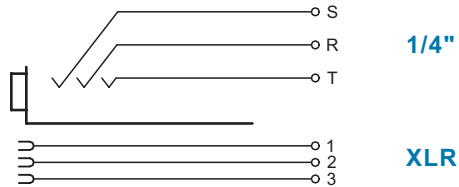

- 9 -

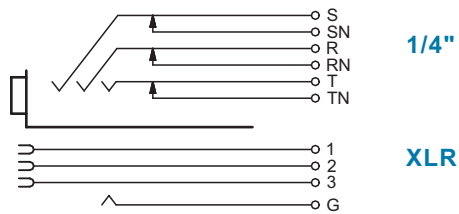

- 10 -

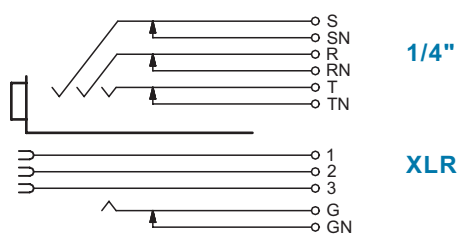

NEUTRIK AG
Liechtenstein

Tel.: +423/237 24 24
Fax: +423/232 53 93
www.neutrik.com

Draft. Nr.: Combo Circuits
Update: 26.08. 2003

NEUTRIK Zürich AG
Switzerland

Tel.: +41 1/736 5010
Fax: +41 1/736 5011

NEUTRIK (UK) Ltd.
Great Britain

Tel.: +44 1983/811 441
Fax: +44 1983/811 439

NEUTRIK USA INC.
USA

Tel.: +1 732/901 9488
Fax: +1 732/901 9608

NEUTRIK Tokyo Ltd.
Japan

Tel.: +81 3/3663 4733
Fax: +81 3/3663 4796

NEUTRIK Vertriebs GmbH
Germany / Netherlands

Tel.: +49 8131/28 08 90
Fax: +49 8131/28 08-30



NEUTRIK
CONNECTING THE WORLD