

# Solid State Relay G3R-I/O

## Compact SSRs for I/O Interface with High Dielectric Strength Requirements

- High-speed models with optimum input ratings for a variety of sensors are available.
- Input Modules and Output Modules that have the same form-factor as the G2R.
- Using a coupler approved by VDE 0884 and assuring an I/O dielectric strength of 4 kV.
- Incorporating an easy-to-see monitoring indicator.
- Approved by UL, CSA, and TÜV. ("-UTU" models)



## Ordering Information

To Order: Select the part number and add the desired coil voltage rating, (e.g., G3R-IAZR1SN-DC5)

### Input Module

Isolation	Indicator	Response speed	Logic level		Rated input voltage	Model
			Supply voltage	Supply current		
Photocoupler	Yes	—	4 to 32 VDC	0.1 to 100 mA	100 to 240 VAC	G3R-IAZR1SN
		High-speed (1 kHz)			5 VDC	G3R-IDZR1SN
		Low-speed (10 Hz)			12 to 24 VDC	G3R-IDZR1SN-1
					5 VDC	
12 to 24 VDC						

### Output Module

Isolation	Indicator	Zero cross function	Rated output load	Rated input voltage	Model
Phototriac	Yes	Yes	2 A at 100 to 240 VAC	5 to 24 VDC	G3R-OA202SZN
		No			G3R-OA202SLN
Photocoupler	—	—	2 A at 5 to 48 VDC		G3R-ODX02SN
			1.5 A at 48 to 200 VDC		G3R-OD201SN

**Note:** When ordering a UL, CSA and EN (TÜV) approved model, add "-UTU" to the model number as shown below:  
Example: G3R-OA202SZN-UTU DC5-24.

### I/O Indication

I/O module classification and AC/DC use are indicated on the mark affixed to the top of the product.

Mark indication	Specification
AC IN	Input module, AC input
DC IN	Input module, DC input
AC OUT	Output module, AC output
DC OUT	Output module, DC output



# Specifications

## ■ Ratings (at an Ambient Temperature of 25°C)

### Input Module

#### Input

Model	Rated voltage	Operating voltage	Input current	Must operate voltage	Must release voltage
G3R-IAZR1SN	100 to 240 VAC	60 to 264 VAC	15 mA max.	60 VAC max.	20 VAC min.
G3R-IDZR1SN	5 VDC	4 to 6 VDC	8 mA max.	4 VDC max.	1 VDC min.
	12 to 24 VDC	6.6 to 32 VDC		6.6 VDC max.	3.6 VDC min.
G3R-IDZR1SN-1	5 VDC	4 to 6 VDC		4 VDC max.	1 VDC min.
	12 to 24 VDC	6.6 to 32 VDC		6.6 VDC max.	3.6 VDC min.

#### Output

Model	Logic level supply voltage	Logic level supply current
G3R-IAZR1SN	4 to 32 VDC	0.1 to 100 mA
G3R-IDZR1SN		
G3R-IDZR1SN-1		

### Output Module

#### Input

Model	Rated voltage	Operating voltage	Input current	Must operate voltage	Must release voltage
G3R-OA202SZN	5 to 24 VDC	4 to 32 VDC	15 mA max. (at 25°C)	4 VDC max.	1 VDC min.
G3R-OA202SLN			8 mA max.		
G3R-ODX02SN					
G3R-OD201SN					

#### Output

Model	Rated load voltage	Load voltage range	Load current (see note)	Inrush current
G3R-OA202SZN	100 to 240 VAC	75 to 264 VAC	0.05 to 2 A	30 A (60 Hz, 1 cycle)
G3R-OA202SLN				
G3R-ODX02SN	5 to 48 VDC	4 to 60 VDC	0.01 to 2 A	8 A (10 ms)
G3R-OD201SN	48 to 200 VDC	40 to 200 VDC	0.01 to 1.5 A	8 A (10 ms)

Note: The minimum current value is measured at 10°C min.

# Characteristics

## ■ Input Module

Item	G3R-IAZR1SN	G3R-IDZR1SN	G3R-IDZR1SN-1
Operate time	20 ms max.	0.1 ms max.	15 ms max.
Release time	20 ms max.	0.1 ms max.	15 ms max.
Response frequency	10 Hz	1 kHz	10 Hz
Output ON voltage drop	1.6 V max.		
Leakage current	5 $\mu$ A max.		
Insulation resistance	100 M $\Omega$ min. between input and output		
Dielectric strength	4,000 VAC, 50/60 Hz for 1 min. between input and output		
Vibration resistance	10 to 55 Hz, 1.5-mm double amplitude		
Shock resistance	1,000 m/s <sup>2</sup> {approx. 100G}		
Ambient temperature	Operating: -30°C to 80°C (with no icing) Storage: -30°C to 100°C (with no icing)		
Approved standards	UL File No. E64562 CSA File No. LR35535 TÜV File No. R9650094 (EN60950)		
Ambient humidity	Operating: 45% to 85%		
Weight	Approx. 18 g		

## ■ Output Module

Item	G3R-OA202SZN	G3R-OA202SLN	G3R-ODX02SN	G3R-OA201SN
Operate time	1/2 of load power source cycle + 1 ms max.		1 ms max.	
Release time	1/2 of load power source cycle + 1 ms max.		2 ms max.	
Response frequency	20 Hz		100 Hz	
Output ON voltage drop	1.6 V max.			2.5 V max.
Leakage current	1.5 mA max.		1 mA max.	
Insulation resistance	100 M $\Omega$ min. between input and output			
Dielectric strength	4,000 VAC, 50/60 Hz for 1 min. between input and output			
Vibration resistance	10 to 55 Hz, 1.5-mm double amplitude			
Shock resistance	1,000 m/s <sup>2</sup> {approx. 100G}			
Ambient temperature	Operating: -30°C to 80°C (with no icing) Storage: -30°C to 100°C (with no icing)			
Approved standards	UL File No. E64562 CSA File No. LR35535 TÜV File No. R9650094 (EN60950)			
Ambient humidity	Operating: 45% to 85%			
Weight	Approx. 18 g			

# Engineering Data

## Load Current vs. Ambient Temperature

G3R-OA202SZN(-UTU)/OA202SLN(-UTU)    G3R-ODX02SN(-UTU) (4 to 60 VDC)    G3R-OD201SN(-UTU) (40 to 200 VAC)

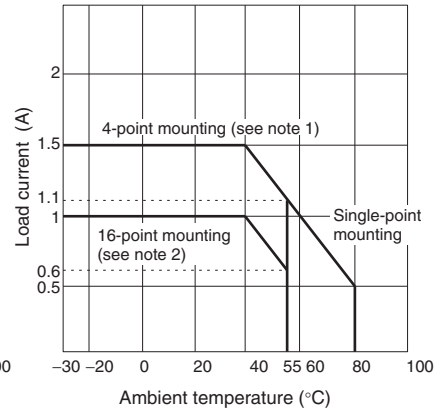

**Note:** 1. When G730-Z0M04-B is mounted.  
2. When G70A-Z0C16 is mounted.

## Inrush Current Resistivity

Non-repetitive (Keep the inrush current to half the rated value if it occurs repetitively.)

G3R-OA202SZN(-UTU)/OA202SLN(-UTU)

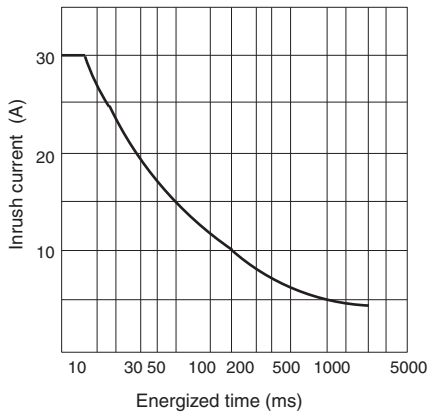

G3R-ODX02SN(-UTU)

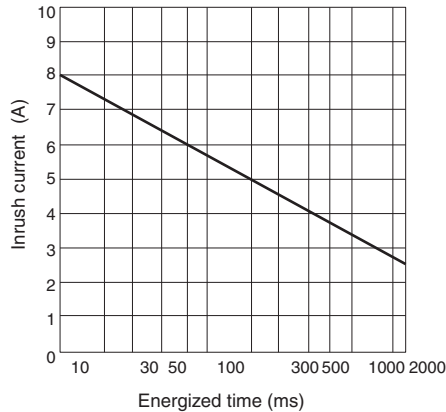

G3R-OD201SN(-UTU)

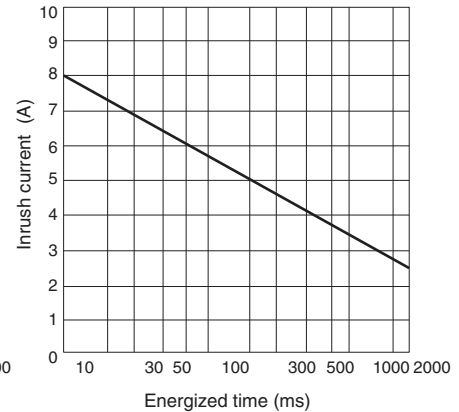

# Dimensions

Unit: mm (inch)

## ■ G3R

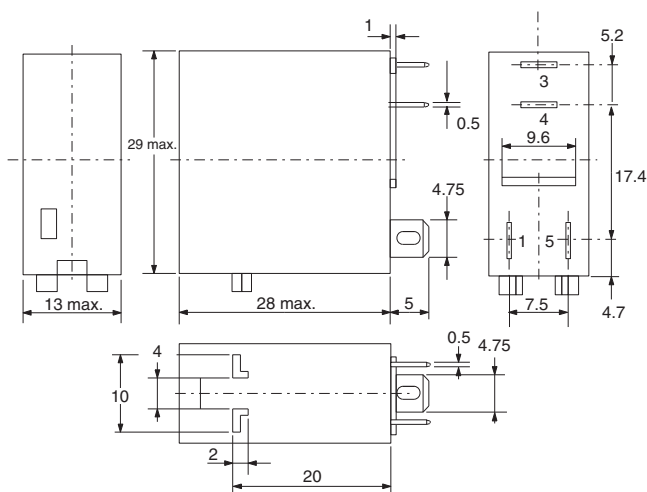

Terminal Arrangement/  
Internal Connections  
(Bottom View)

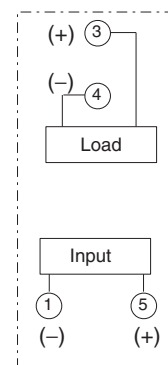

## ■ Connecting Sockets

### P2RF-05

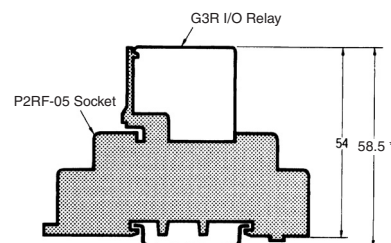

\* Indicates a value when using the PFP-□N Supporting Rail. The value is 67.5 when using the PFP-□N2.

### P2RF-05-E

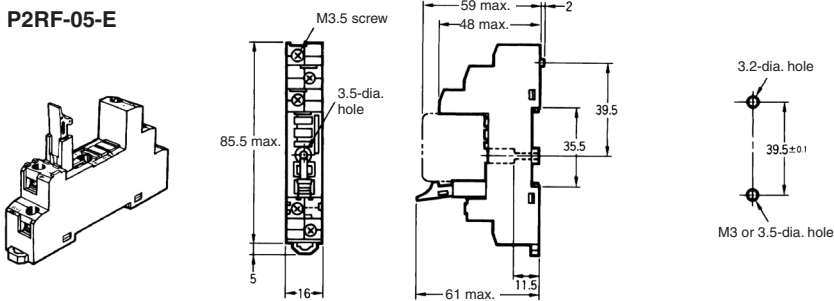

\*\* Indicates a value when using the PFP-□N Supporting Rail with the P2RF-05-E. The value is 71.5 when using the PFP-□N2.

\*\*\* Indicates a value when using the PFP-□N Supporting Rail with the P2RF-08-E. The value is 75.5 when using the PFP-□N2.

### P2R-05A

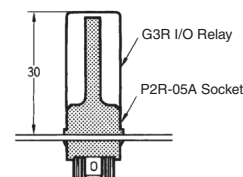
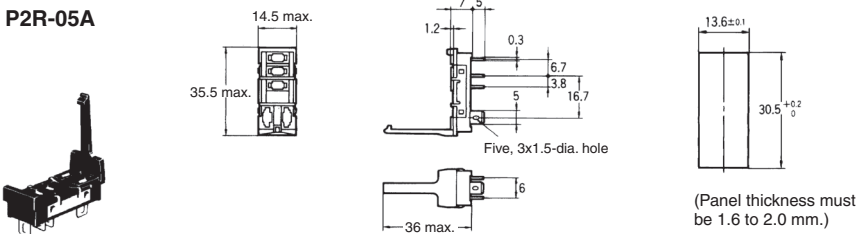

(For use when mounting in a panel or in the P2R-P mounting plate)

**P2R-05P**

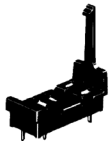

Dimensional tolerance is  $\pm 0.1$ .



**P2R-057P**

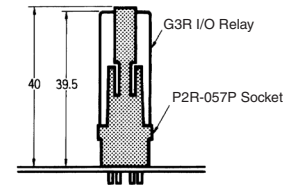
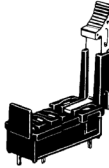

**■ Socket Mounting Plate**

Use the P2R-P Socket Mounting Plate when arranging several P2R-05A Sockets in a row.

**P2R-P**

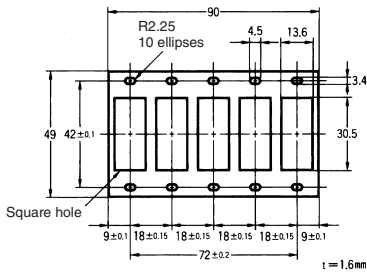

**■ Approvals**

UL Recognized (File No. E64562) / CSA Certified (File No. LR35535)

Model G3R-	Module type	Rating
IAZR1SN	Input	100 to 240 VAC
IDZR1SN	Input	5 VDC, 12 to 24 VDC
IDZR1SN-1	Input	5 VDC, 12 to 24 VDC
OA202SZN	Output	5 to 24 VDC
OA202SLN	Output	5 to 24 VDC
ODX02SN	Output	5 to 24 VDC
OD201SN	Output	5 to 24 VDC

Model G3R-	Module type	Output rating
IAZR1SN	Input	32 VDC, 100 mA (General Purpose)
IDZR1SN	Input	32 VDC, 100 mA (General Purpose)
IDZR1SN-1	Input	32 VDC, 100 mA (General Purpose)
OA202SZN	Output	264 VAC, 2 A (General Purpose)
		264 VAC, 1 A (Tungsten)
		264 VAC, 1 A FLA, 6 A LRA
OA202SLN	Output	264 VAC, 2 A (General Purpose)
		264 VAC, 1 A (Tungsten)
		264 VAC, 1 A FLA, 6 A LRA
ODX02SN	Output	60 VDC, 2 A (General Purpose)
		60 VDC, 1 A (Tungsten)
OD201SN	Output	200 VDC, 1.5 A (General Purpose)
		200 VDC, 0.75 A (Tungsten)

# Precautions

---

## ■ Connection

With the SSR for DC switching, the load can be connected to either positive or negative output terminal of the SSR.

## ■ Protective element

Since the SSR does not incorporate an overvoltage absorption component, be sure to connect an overvoltage absorption component when using the SSR under an inductive load.

## ■ Precaution of Mounting Output Modules

With up to four G3R SSRs mounted closely and side by side, 2-A loads can be switched.



With a G3R SSRs mounted every other slot, 2-A loads can be switched.

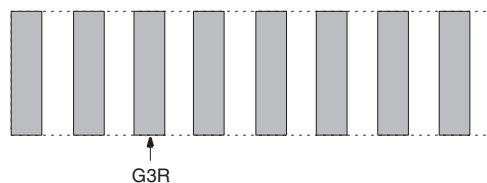

# Terms and Conditions of Sale

- Offer; Acceptance.** These terms and conditions (these "Terms") are deemed part of all quotes, agreements, purchase orders, acknowledgments, price lists, catalogs, manuals, brochures and other documents, whether electronic or in writing, relating to the sale of products or services (collectively, the "Products") by Omron Electronics LLC and its subsidiary companies ("Omron"). Omron objects to any terms or conditions proposed in Buyer's purchase order or other documents which are inconsistent with, or in addition to, these Terms.
- Prices; Payment Terms.** All prices stated are current, subject to change without notice by Omron. Omron reserves the right to increase or decrease prices on any unshipped portions of outstanding orders. Payments for Products are due net 30 days unless otherwise stated in the invoice.
- Discounts.** Cash discounts, if any, will apply only on the net amount of invoices sent to Buyer after deducting transportation charges, taxes and duties, and will be allowed only if (i) the invoice is paid according to Omron's payment terms and (ii) Buyer has no past due amounts.
- Interest.** Omron, at its option, may charge Buyer 1-1/2% interest per month or the maximum legal rate, whichever is less, on any balance not paid within the stated terms.
- Orders.** Omron will accept no order less than \$200 net billing.
- Governmental Approvals.** Buyer shall be responsible for, and shall bear all costs involved in, obtaining any government approvals required for the importation or sale of the Products.
- Taxes.** All taxes, duties and other governmental charges (other than general real property and income taxes), including any interest or penalties thereon, imposed directly or indirectly on Omron or required to be collected directly or indirectly by Omron for the manufacture, production, sale, delivery, importation, consumption or use of the Products sold hereunder (including customs duties and sales, excise, use, turnover and license taxes) shall be charged to and remitted by Buyer to Omron.
- Financial.** If the financial position of Buyer at any time becomes unsatisfactory to Omron, Omron reserves the right to stop shipments or require satisfactory security or payment in advance. If Buyer fails to make payment or otherwise comply with these Terms or any related agreement, Omron may (without liability and in addition to other remedies) cancel any unshipped portion of Products sold hereunder and stop any Products in transit until Buyer pays all amounts, including amounts payable hereunder, whether or not then due, which are owing to it by Buyer. Buyer shall in any event remain liable for all unpaid accounts.
- Cancellation; Etc.** Orders are not subject to rescheduling or cancellation unless Buyer indemnifies Omron against all related costs or expenses.
- Force Majeure.** Omron shall not be liable for any delay or failure in delivery resulting from causes beyond its control, including earthquakes, fires, floods, strikes or other labor disputes, shortage of labor or materials, accidents to machinery, acts of sabotage, riots, delay in or lack of transportation or the requirements of any government authority.
- Shipping; Delivery.** Unless otherwise expressly agreed in writing by Omron:
  - Shipments shall be by a carrier selected by Omron; Omron will not drop ship except in "break down" situations.
  - Such carrier shall act as the agent of Buyer and delivery to such carrier shall constitute delivery to Buyer;
  - All sales and shipments of Products shall be FOB shipping point (unless otherwise stated in writing by Omron), at which point title and risk of loss shall pass from Omron to Buyer; provided that Omron shall retain a security interest in the Products until the full purchase price is paid;
  - Delivery and shipping dates are estimates only; and
  - Omron will package Products as it deems proper for protection against normal handling and extra charges apply to special conditions.
- Claims.** Any claim by Buyer against Omron for shortage or damage to the Products occurring before delivery to the carrier must be presented in writing to Omron within 30 days of receipt of shipment and include the original transportation bill signed by the carrier noting that the carrier received the Products from Omron in the condition claimed.
- Warranties.** (a) **Exclusive Warranty.** Omron's exclusive warranty is that the Products will be free from defects in materials and workmanship for a period of twelve months from the date of sale by Omron (or such other period expressed in writing by Omron). Omron disclaims all other warranties, express or implied. (b) **Limitations.** OMRON MAKES NO WARRANTY OR REPRESENTATION, EXPRESS OR IMPLIED, ABOUT NON-INFRINGEMENT, MERCHANTABILITY OR FITNESS FOR A PARTICULAR PURPOSE OF THE PRODUCTS. BUYER ACKNOWLEDGES THAT IT ALONE HAS DETERMINED THAT THE PRODUCTS WILL SUITABLY MEET THE REQUIREMENTS OF THEIR INTENDED USE. Omron further disclaims all warranties and responsibility of any type for claims or expenses based on infringement by the Products or otherwise of any intellectual property right. (c) **Buyer Remedy.** Omron's sole obligation hereunder shall be, at Omron's election, to (i) replace (in the form originally shipped with Buyer responsible for labor charges for removal or replacement thereof) the non-complying Product, (ii) repair the non-complying Product, or (iii) repay or credit Buyer an amount equal to the purchase price of the non-complying Product; provided that in no event shall Omron be responsible for warranty, repair, indemnity or any other claims or expenses regarding the Products unless Omron's analysis confirms that the Products were properly handled, stored, installed and maintained and not subject to contamination, abuse, misuse or inappropriate modification. Return of any Products by Buyer must be approved in writing by Omron before shipment. Omron Companies shall not be liable for the suitability or unsuitability or the results from the use of Products in combination with any electrical or electronic components, circuits, system assemblies or any other materials or substances or environments. Any advice, recommendations or information given orally or in writing, are not to be construed as an amendment or addition to the above warranty. See <http://www.omron247.com> or contact your Omron representative for published information.
- Limitation on Liability; Etc.** OMRON COMPANIES SHALL NOT BE LIABLE FOR SPECIAL, INDIRECT, INCIDENTAL, OR CONSEQUENTIAL DAMAGES, LOSS OF PROFITS OR PRODUCTION OR COMMERCIAL LOSS IN ANY WAY CONNECTED WITH THE PRODUCTS, WHETHER SUCH CLAIM IS BASED IN CONTRACT, WARRANTY, NEGLIGENCE OR STRICT LIABILITY. Further, in no event shall liability of Omron Companies exceed the individual price of the Product on which liability is asserted.
- Indemnities.** Buyer shall indemnify and hold harmless Omron Companies and their employees from and against all liabilities, losses, claims, costs and expenses (including attorney's fees and expenses) related to any claim, investigation, litigation or proceeding (whether or not Omron is a party) which arises or is alleged to arise from Buyer's acts or omissions under these Terms or in any way with respect to the Products. Without limiting the foregoing, Buyer (at its own expense) shall indemnify and hold harmless Omron and defend or settle any action brought against such Companies to the extent based on a claim that any Product made to Buyer specifications infringed intellectual property rights of another party.
- Property; Confidentiality.** Any intellectual property in the Products is the exclusive property of Omron Companies and Buyer shall not attempt to duplicate it in any way without the written permission of Omron. Notwithstanding any charges to Buyer for engineering or tooling, all engineering and tooling shall remain the exclusive property of Omron. All information and materials supplied by Omron to Buyer relating to the Products are confidential and proprietary, and Buyer shall limit distribution thereof to its trusted employees and strictly prevent disclosure to any third party.
- Export Controls.** Buyer shall comply with all applicable laws, regulations and licenses regarding (i) export of products or information; (ii) sale of products to "forbidden" or other proscribed persons; and (iii) disclosure to non-citizens of regulated technology or information.
- Miscellaneous.** (a) **Waiver.** No failure or delay by Omron in exercising any right and no course of dealing between Buyer and Omron shall operate as a waiver of rights by Omron. (b) **Assignment.** Buyer may not assign its rights hereunder without Omron's written consent. (c) **Law.** These Terms are governed by the law of the jurisdiction of the home office of the Omron company from which Buyer is purchasing the Products (without regard to conflict of law principles). (d) **Amendment.** These Terms constitute the entire agreement between Buyer and Omron relating to the Products, and no provision may be changed or waived unless in writing signed by the parties. (e) **Severability.** If any provision hereof is rendered ineffective or invalid, such provision shall not invalidate any other provision. (f) **Setoff.** Buyer shall have no right to set off any amounts against the amount owing in respect of this invoice. (g) **Definitions.** As used herein, "including" means "including without limitation"; and "Omron Companies" (or similar words) mean Omron Corporation and any direct or indirect subsidiary or affiliate thereof.

## Certain Precautions on Specifications and Use

- Suitability of Use.** Omron Companies shall not be responsible for conformity with any standards, codes or regulations which apply to the combination of the Product in the Buyer's application or use of the Product. At Buyer's request, Omron will provide applicable third party certification documents identifying ratings and limitations of use which apply to the Product. This information by itself is not sufficient for a complete determination of the suitability of the Product in combination with the end product, machine, system, or other application or use. Buyer shall be solely responsible for determining appropriateness of the particular Product with respect to Buyer's application, product or system. Buyer shall take application responsibility in all cases but the following is a non-exhaustive list of applications for which particular attention must be given:
  - Outdoor use, uses involving potential chemical contamination or electrical interference, or conditions or uses not described in this document.
  - Use in consumer products or any use in significant quantities.
  - Energy control systems, combustion systems, railroad systems, aviation systems, medical equipment, amusement machines, vehicles, safety equipment, and installations subject to separate industry or government regulations.
  - Systems, machines and equipment that could present a risk to life or property. Please know and observe all prohibitions of use applicable to this Product.

NEVER USE THE PRODUCT FOR AN APPLICATION INVOLVING SERIOUS RISK TO LIFE OR PROPERTY OR IN LARGE QUANTITIES WITHOUT ENSURING THAT THE SYSTEM AS A WHOLE HAS BEEN DESIGNED TO ADDRESS THE RISKS, AND THAT THE OMRON'S PRODUCT IS PROPERLY RATED AND INSTALLED FOR THE INTENDED USE WITHIN THE OVERALL EQUIPMENT OR SYSTEM.
- Programmable Products.** Omron Companies shall not be responsible for the user's programming of a programmable Product, or any consequence thereof.
- Performance Data.** Data presented in Omron Company websites, catalogs and other materials is provided as a guide for the user in determining suitability and does not constitute a warranty. It may represent the result of Omron's test conditions, and the user must correlate it to actual application requirements. Actual performance is subject to the Omron's Warranty and Limitations of Liability.
- Change in Specifications.** Product specifications and accessories may be changed at any time based on improvements and other reasons. It is our practice to change part numbers when published ratings or features are changed, or when significant construction changes are made. However, some specifications of the Product may be changed without any notice. When in doubt, special part numbers may be assigned to fix or establish key specifications for your application. Please consult with your Omron's representative at any time to confirm actual specifications of purchased Product.
- Errors and Omissions.** Information presented by Omron Companies has been checked and is believed to be accurate; however, no responsibility is assumed for clerical, typographical or proofreading errors or omissions.





**OMRON ELECTRONICS LLC • THE AMERICAS HEADQUARTERS** • Schaumburg, IL USA • 847.843.7900 • 800.556.6766 • [www.omron247.com](http://www.omron247.com)

**OMRON CANADA, INC. • HEAD OFFICE**

Toronto, ON, Canada • 416.286.6465 • 866.986.6766  
[www.omron247.com](http://www.omron247.com)

**OMRON ELETRÔNICA DO BRASIL LTDA • HEAD OFFICE**

São Paulo, SP, Brasil • 55.11.2101.6300 • [www.omron.com.br](http://www.omron.com.br)

**OMRON ELECTRONICS MEXICO SA DE CV • HEAD OFFICE**

Apodaca, N.L. • 52.811.156.99.10 • 001.800.556.6766 • [mela@omron.com](mailto:mela@omron.com)

**OMRON ARGENTINA • SALES OFFICE**

Cono Sur • 54.11.4783.5300

**OMRON CHILE • SALES OFFICE**

Santiago • 56.9.9917.3920

**OTHER OMRON LATIN AMERICA SALES**

54.11.4783.5300

**OMRON EUROPE B.V.** Wegalaan 67-69, NL-2132 JD, Hoofddorp, The Netherlands. Tel: +31 (0) 23 568 13 00 Fax: +31 (0) 23 568 13 88 [www.industrial.omron.eu](http://www.industrial.omron.eu)