

Model H25[®] Absolute Encoder

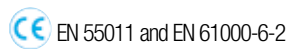

Long considered the industry standard for shafted incremental encoders, the Model H25 is now available in an absolute version with up to 13 Bits of resolution. It incorporates many of the great standard features of the incremental version, including: EMI shielding, 40-lb ABEC 7 bearings, matched thermal coefficients on critical components, and custom optics. This encoder features a 12 or 13 Bit absolute parallel gray code output, a selection line for count direction, and an output latch as standard. Output is standard gray code with options for natural binary or SSI compatible signals. Signals can be provided in either a single-ended multi-voltage line driver (TTL compatible when provided with 5 volts) or as an open-collector style of output. Typical applications include dam gate control, cranes, telescopes, tool changers, and robotics.

The H25 Absolute Encoder is available with the following certification:



Mechanical Specifications

Shaft Diameter: 3/8" (1/2" as special feature)
Flat On Shaft: 3/8" Shaft: 0.80 long X 0.03" deep; 1/2" Shaft: 0.80 long X 0.04" deep (1/2" shaft w/flat must be ordered as a special feature)
Shaft Loading: 3/8" shaft: Up to 40 pounds axial and 35 pounds radial; 1/2" shaft: Up to 90 pounds axial and 80 pounds radial
Shaft Runout: 0.0005 T.I.R. at midpoint regardless of shaft diameter
Starting Torque at 25°C: Without shaft seal 1.0 in-oz (max); With shaft seal 2.5 in-oz (max); 1/2" shaft with shaft seal: 3.5 in-oz (max)
Bearings: Class ABEC 7 standard, ABEC 5 for 1/2" shaft
Shaft Material: 416 stainless steel
Bearing Housing: Die cast aluminum with protective finish; stainless steel (special feature)
Cover: Die cast aluminum; stainless steel (special feature)
Bearing Life: 2 X 10⁸ revs (1300 hrs at 2500 RPM) at rated load 1 X 10¹⁰ revs (67,000 hrs at 2500 RPM) at 10% of rated load

Maximum RPM: 12,000 RPM nominal, 8000 RPM with 1/2" shaft (see Frequency Response, below) 30,000 RPM available on units with 3/8" shaft—consult with factory
Moment of Inertia: 4.1 X 10⁻⁴ oz-in-sec²; 5.2 X 10⁻⁴ oz-in-sec² with 1/2" shaft
Weight: 13 oz typical, 14.5 oz typical with 1/2" shaft

Electrical Specifications

Code: 12 or 13 bits NB or GC; excess gray and BCD available
Counts Per Shaft Turn: 4096 or 8192
Count Transition Accuracy: ± 1/2 bit maximum
Supply Voltage: 5–28 VDC
Current Requirements: 120 mA typical
Output Formats: Parallel: Gray Code, Natural Binary and Binary Coded Decimal; Serial: Serial Synchronous Interface (SSI) compatible; Analog: 4–20 mA, 0–10V
Voltage/Output: (see note 3)
 28V/V: Line Driver, 5–28 VDC in, V_{out} = V_{in}
 28V/5: Line Driver, 5–28 VDC in, V_{out} = 5 VDC
 28V/OC: Open Collector, 5–28 VDC in OC_{out}
 SSI: 5–28 VDC In/5V_{out}

Protection Level: Reverse, overvoltage and output short circuit protection
Frequency Response: 100kHz (1200 RPM for 12-bits, 600 RPM for 13-bits)
Output Termination Pinouts: see Table 1, back page

Environmental Specifications

Enclosure Rating: NEMA 4 & 13 (IP 66) when ordered with shaft seal (on units with an MS connector) or a cable gland (on units with cable termination).
Temperature: Operating, 0° to 70° C; extended temperature testing available (see note 5); Storage, -25° to 90° C unless extended temperature option called out.
Shock: 50 g's for 11 msec duration
Vibration: 5 to 2000 Hz @ 20 g's
Humidity: 98% RH without condensation

Connector

MS3112E14-19P, 19-pin connector on encoder body, mates to MS3116J14-19S (or equivalent)

NOTES & TABLES: All notes and tables referred to in the text can be found on the back of this page.

H25 Absolute Encoder Ordering Options for assistance call 800-350-2727

Use this diagram, working from left to right to construct your model number (example: H25E-F4-SS-12GC-28V/V-CW-SM14/19).

All notes and tables referred to can be found on the back of these pages.

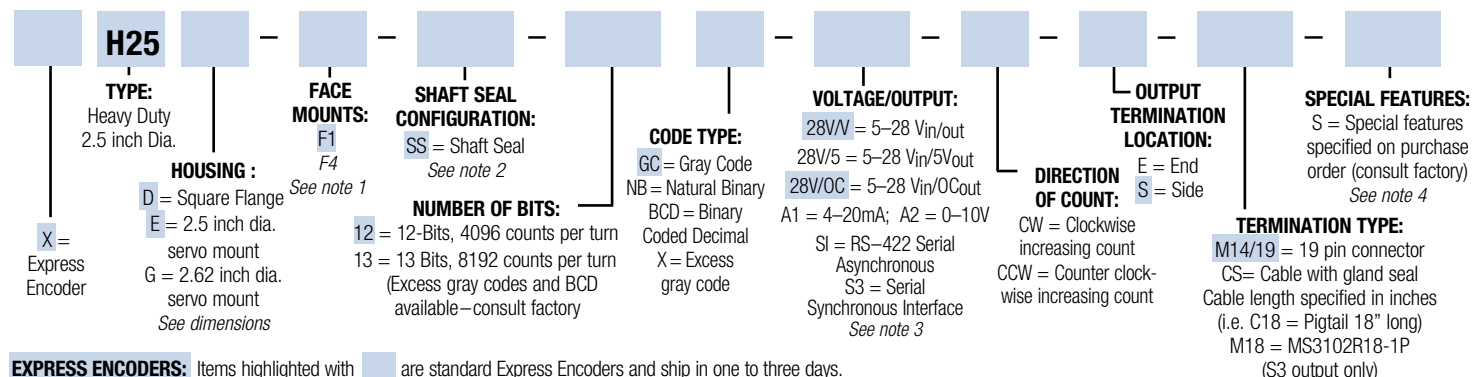

EXPRESS ENCODERS: Items highlighted with are standard Express Encoders and ship in one to three days.



Tel: 805-968-0782 / 800-350-2727 | Fax: 805-968-3154 / 800-960-2726
 7230 Hollister Ave., Goleta, CA 93117-2807 | www.beisensors.com

Specification No. 02067-001 Rev.11-11

Serial Synchronous Interface (SSI)

SSI output provides effective synchronization in a closed-loop control system. A clock pulse train from a controller is used to clock out sensor data: one bit of position data is transmitted to the controller per one clock pulse received by the sensor. The use of a differential driver permits reliable transmission of data over long distances in environments that may be electrically noisy. The encoder utilizes a clock signal, provided by the user interface, to time the data transmission. Receiving electronics must include an appropriate receiver as well as line terminating resistors.

Features : • Synchronous transmission • Transmission lengths to 1000 feet • Accepts clock rates from 100 KHz to 1.8 MHz

Data Transmission Sequence

1. Output driver of the encoder is a MAX 491 transceiver in transmit mode. The recommended receiver is a MAX 491 transceiver in receive mode.
2. Controller provides a series of pulses (or differential pulse pairs) on the CLOCK input lines.
3. On the first HIGH-to-LOW CLOCK transition, the encoder latches its data at the current position and prepares to transmit.
4. Controller reads data on the falling edge of the next 15 clock cycles.
5. The first bit is a START bit and is always HIGH.
6. Next comes 13 data bits beginning with the most significant bit (MSB) and ending with the parity bit. On 12 bit encoders, bit 13 is LOW. When parity is not ordered, parity is LOW.
7. After the last CLOCK HIGH-to-LOW transition, a minimum of 40 microseconds must pass before the beginning of the next CLOCK series.

Interfacing Long Data Lines

Ordering SSI : HOW TO SPECIFY SSI OUTPUT IN THE ENCODER MODEL NUMBER: Use the designation, S3 between the Code Format designation and the Connector designation. **Example: H25D-SS-12G-C3-CW-SM18**

Cable impedance can create a transmission delay, in effect, shifting the phase relationship between the clock pulse and the data. If this phase shift exceeds 180°, then the wrong bit position will be sampled by the receiver. As a result, the maximum allowable clock frequency is a function of the cable length. For 24 AWG, stranded, 3 pair cable (BEI part number 37048-003 or equivalent) the group delay is 1.36ns/ft. The table below shows the maximum transmission rate allowable as a function of cable length to ensure a phase shift of less than 90°.

CLOCK, Maximum (kHz) = 92,000 / Cable Length (ft)CW						
Cable Length (ft)	50	100	200	300	500	1000
Max Freq (kHz)	1800	900	500	300	200	100

SSI Timing

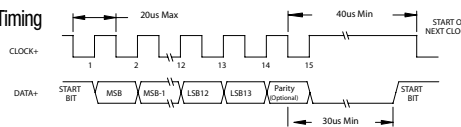

Dimensions

H25D - Square Flange

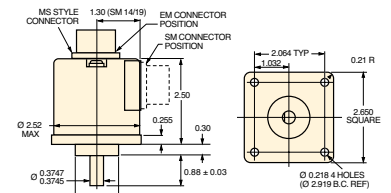

H25E - 2.50 Servo Mount

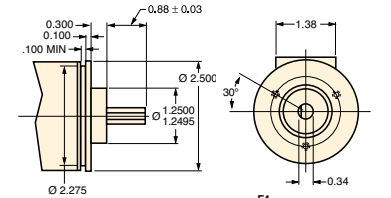

H25G - 2.62 Dia Servo Mount

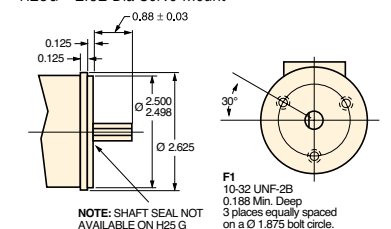

Output Code and Terminations						
	PARALLEL CODE		TERMINATION TYPE			
	Gray Code	Natural Binary	Cable	M14/19 Conn		
MSB	12 Bit	12 Bit	WHT/BLK	A		
	G ₁₅	2 ¹⁵			WHT/BRN	B
	G ₁₄	2 ¹⁴			WHT/RED	C
	G ₁₃	2 ¹³			WHT/ORN	D
	G ₁₂	2 ¹²			WHT/YEL	E
	G ₁₁	2 ¹¹			WHT/GRN	F
	G ₁₀	2 ¹⁰			WHT/BLU	G
	G ₉	2 ⁹			WHT/IO	H
	G ₈	2 ⁸			WHT/GRY	J
	G ₇	2 ⁷			WHT	K
	G ₆	2 ⁶			GRY/BLK	L
	G ₅	2 ⁵			GRY/BRN	M
LSB ₄		GRY/RED	N			
	0V (CIRCUIT COMMON)1		GRY/ORN	P		
	DIRECTION OF COUNT		ORN	R		
	CASE GROUND		GRN	S		
	0V (CIRCUIT COMMON)		BLK	T		
	LATCH CONTROL		YEL	U		
	+V (SUPPLY VOLTAGE)		RED	V		
	SHIELD DRAIN		BARE	—		

SSI Output Termination Table			
	M18 Conn	M14/19 Conn	Cable Conn
DATA +	A	A	YEL
DATA-	H	B	WHT/YEL
CLOCK+	B	C	BLU
CLOCK-	I	D	WHT/BLU
DIR CONTROL	C	R	ORN
CASE GROUND	G	S	GRN
CIRCUIT COMMON	F	T	BLK
+V SUPPLY VOLTAGE	D	V	RED
SHIELD DRAIN	—	—	BARE

Direction of Count: Standard is CW increasing when viewed from the shaft end. Pin R is normally HI (or N/C) and is pulled up internally to +V. To reverse the count direction, Pin R must be pulled LO (COMMON).

Latch control: Encoder outputs are active and provide continuous parallel position information when Pin U is HI (or N/C). Pin U is pulled up internally to +V. When Pin U is LO (COMMON) the encoder outputs are latched at the logic state that is present when the latch is applied and will stay latched until Pin U is no longer grounded.

M18 Connector is a MS3102R18-1P, 10-pin connector on the encoder body and mates to an MS3106F18-1S connector or can be used with a standard cable/connector assembly, BEI P/N 924-31186-18XX (Where XX = 10, 20, 30 or 50 for a 10, 20, 30, or 50 foot length). This is the preferred connector for SSI output.

M14/19 Connector is a MS3112E14-19P, 19-pin connector on the encoder body and mates to an MS3116J14-19S or equivalent.

Notes

1. Mounting is usually done either using the D-style square flange mount, E- or G-style servo mounts, or one of the standard face mounts, F1 for example. Consult factory for additional face mount options.
2. The shaft seal is recommended in virtually all installations. The most common exceptions are applications requiring a very low starting torque or those requiring operation at both high temperature and high speed.
3. **Output IC's:** Output IC's are available as either Line Driver (LD) or NPN Open Collector (OC) types. Open Collectors require pull-up resistors, resulting in higher output source impedance (sink impedance is similar to that of line drivers). In general, use of a Line Driver style output is recommended. Line Drivers source or sink current and their lower impedance mean better noise immunity and faster switching times. **Warning:** Do not connect any line driver outputs directly to circuit common/OV, which may damage the driver. Unused outputs should be isolated and left floating. Our applications specialists would be pleased to discuss your system requirements and the compatibility of your receiving electronics with Line Driver type outputs.
4. **28V/V:** Multi-voltage Line Driver (7272*): 100 mA source/sink. Input voltage 5 to 28 VDC +/- 5% standard (Note: V_{OUT} = V_{IN}). This driver is TTL compatible when used with 5 volt supply. Supply lines are protected against overvoltage to 60 volts and reverse voltage. Outputs are short circuit protected for one minute. Supply current is 120 mA typical (plus load current). This is the recommended replacement for 3904R and 7406R open collector outputs with internal pullup resistors. It is also a direct replacement for any 4469, 88C30, 8830 or 26LS31 line driver
5. **28V/5:** Multi-voltage Line Driver (7272*): 100 mA source/sink. Input voltage 5 to 28 VDC +/- 5% standard, internally regulated with 5V (TTL compatible) logic out. Supply lines are protected against overvoltage to 60 volts and reverse voltage. Outputs are short circuit protected for one minute. Supply current is 90 mA typical (plus load current). **Note:** Limit encoder load to 2.5W max at ambient. Example at 12 VDC: 2.5W / (+12VDC minus +5VDC) = 357 mA total allowed current. Consult factory for your specific requirements.
6. **28V/OC:** NPN Open Collector (3904*, 7273*). Current sink of 80 mA max. Current sourced by external pull-up resistor. Output can be pulled up to voltage other than supply voltage (30 V max). Input voltage 5 to 28 VDC +/- 5% standard. Supply current is 120 mA typical. This replaces prior IC's with designations of 3904, 7406, 3302, 681 and 689.
7. Special -S at the end of the model number is used to define a variety of non-standard features such as special shaft lengths, voltage options, or special testing. Please consult the factory to discuss your special requirements.
8. Extended temperature ratings are available in the following ranges: -40 to 70°C, -40 to 85°C. Some models can operate down to -55°C. Extended temperature ranges can affect other performance factors. Consult with factory for more specific information.

*Pin P is available for a tri-state option

Figures

Figure 1 Gray Code

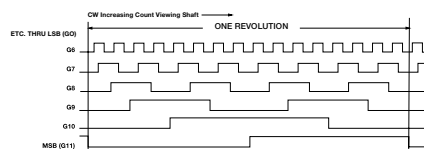
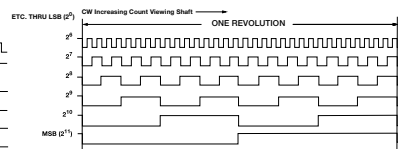

Figure 2 Natural Binary



* Products manufactured prior to April 2007 used the line driver IC number instead of voltage output in model number.