

## STRADA-S

Side emitter beam

### TECHNICAL SPECIFICATIONS:

Dimensions	19.6 x 15.5 mm
Height	6.9 mm
Fastening	pin, screw
ROHS compliant	yes ⓘ

### MATERIAL SPECIFICATIONS:

Component	Type	Material	Colour	Finish
STRADA-S	Single lens	PMMA	clear	



### ORDERING INFORMATION:

Component	Qty in box	MOQ	MPQ	Box weight (kg)
C11249_STRADA-S » Box size: 480 x 280 x 300 mm	2880	288	144	3.5

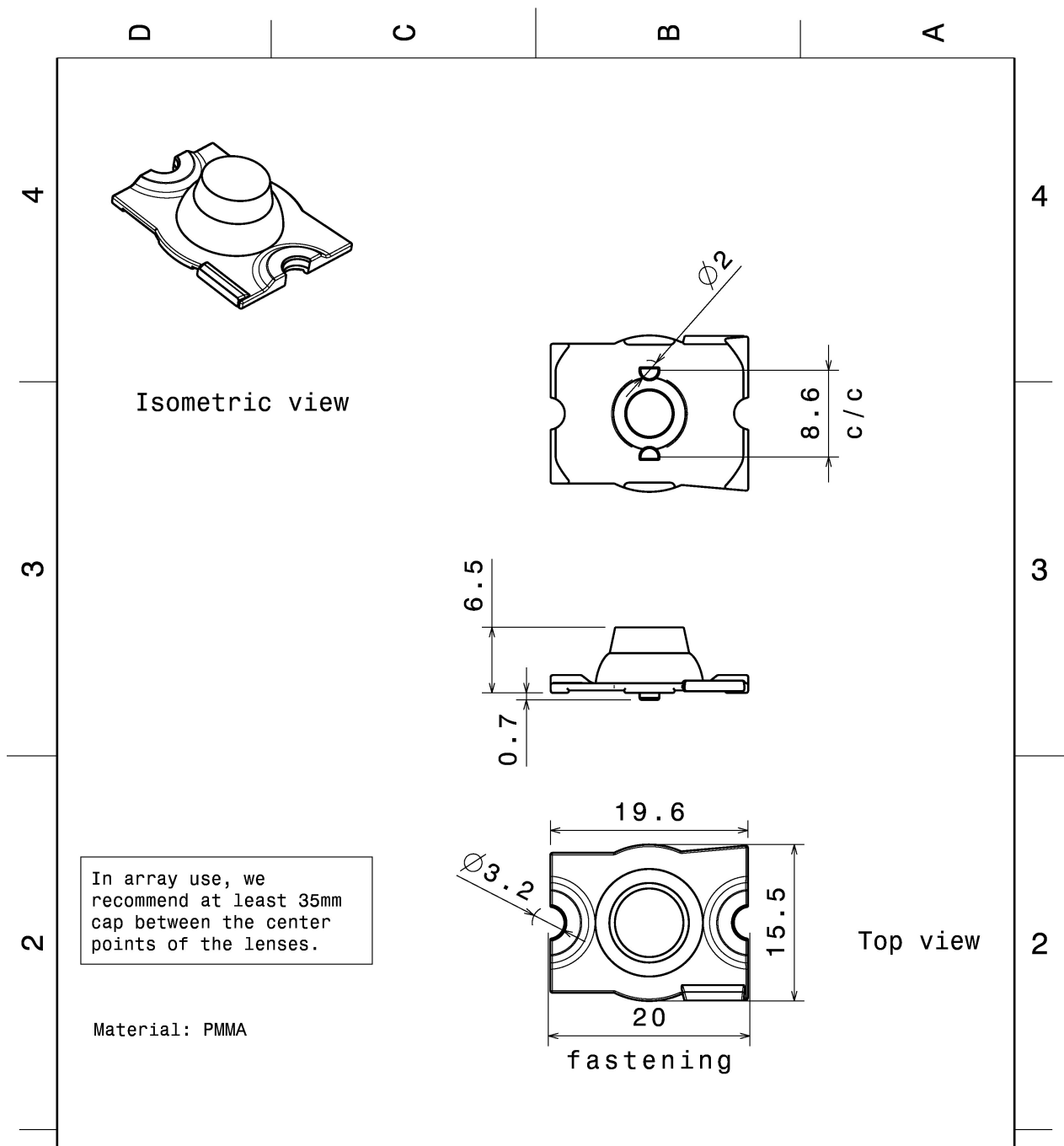

This drawing is our property. It can't be reproduced or communicated without our written agreement.			
DRAWN BY p		DATE 18.12.2009	
CHECKED BY h		DATE 18.12.2009	
DESIGNED BY o1		DATE 18.12.2009	
DRAWING TITLE <b>Datasheet Strada-S lens</b>			
SIZE <b>A4</b>	DRAWING NUMBER <b>C11249</b>		REV <b>1</b>
SCALE <b>2:1</b>	WEIGHT (g)	SHEET <b>1/1</b>	

### PHOTOMETRIC DATA (MEASURED):

#### CREE

LED XP-E  
FWHM 144.0 + 168.0°  
Efficiency 93 %  
Peak intensity 0.5 cd/lm  
LEDs/each optic 1  
Light colour White  
Required components:

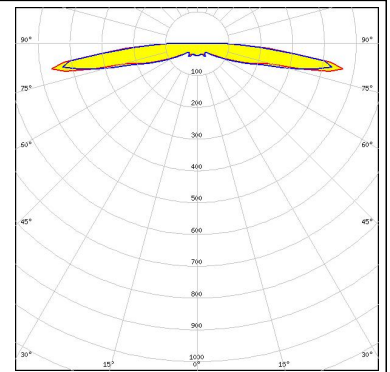

#### CREE

LED XP-G  
FWHM 144.0 + 176.0°  
Efficiency 93 %  
Peak intensity 0.4 cd/lm  
LEDs/each optic 1  
Light colour White  
Required components:

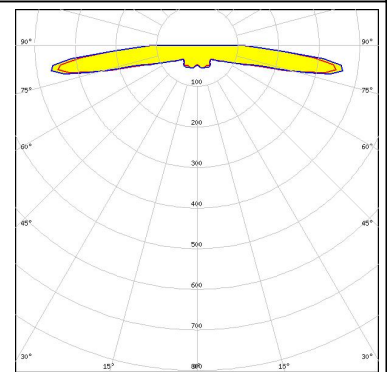

#### CREE

LED XP-G2  
FWHM 169.0°  
Efficiency 94 %  
Peak intensity 0.5 cd/lm  
LEDs/each optic 1  
Light colour White  
Required components:

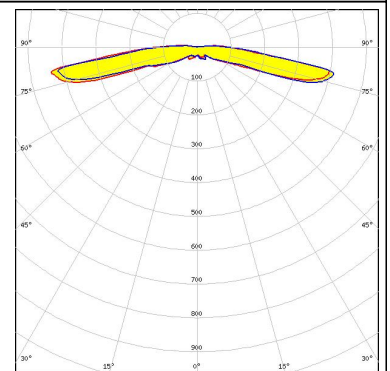

#### LUMILEDS

LED LUXEON Rebel  
FWHM 162.0 + 138.0°  
Efficiency 93 %  
Peak intensity 0.4 cd/lm  
LEDs/each optic 1  
Light colour White  
Required components:

### PHOTOMETRIC DATA (MEASURED):



LED LUXEON Rebel ES  
FWHM 137.0 + 166.0°  
Efficiency 93 %  
Peak intensity 0.3 cd/lm  
LEDs/each optic 1  
Light colour White  
Required components:

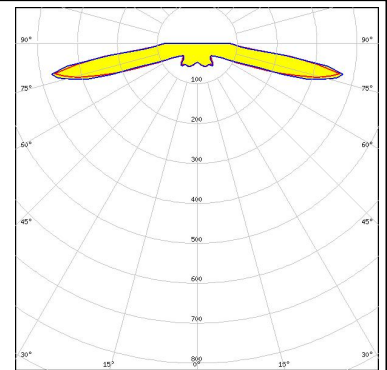

LED NCSxx19A  
FWHM 168.0 + 138.0°  
Efficiency 93 %  
Peak intensity 0.4 cd/lm  
LEDs/each optic 1  
Light colour White  
Required components:



LED NVSxx19A  
FWHM 162.0 + 138.0°  
Efficiency 93 %  
LEDs/each optic 1  
Light colour White  
Required components:



LED OSOLON SSL 150  
FWHM 146.0 + 170.0°  
Efficiency 93 %  
Peak intensity 0.4 cd/lm  
LEDs/each optic 1  
Light colour White  
Required components:

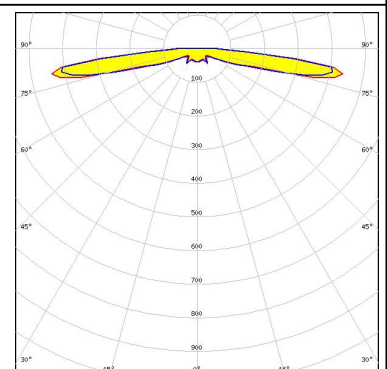

### PHOTOMETRIC DATA (MEASURED):

**OSRAM**  
Opto Semiconductors

LED OSLON SSL 80  
FWHM 161.0°  
Efficiency 93 %  
Peak intensity 0.6 cd/lm  
LEDs/each optic 1  
Light colour White  
Required components:

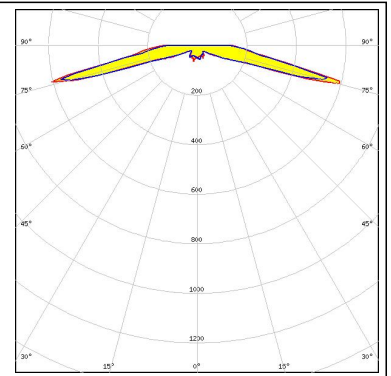

### PHOTOMETRIC DATA (SIMULATED):

#### LUMILEDS

LED LUXEON A  
FWHM 144.0 + 176.0°  
Efficiency %  
LEDs/each optic 1  
Light colour White  
Required components:

#### NICHIA

LED NF2W757G-MT (Tunable White)  
FWHM 167.0 + 168.0°  
Efficiency 91 %  
Peak intensity 0.5 cd/lm  
LEDs/each optic 1  
Light colour Tunable White  
Required components:

#### SEMI SEOUL SEMICONDUCTOR

LED Z5  
FWHM 144.0 + 176.0°  
Efficiency %  
LEDs/each optic 1  
Light colour White  
Required components:

#### SHARP

LED Double Dome (GM2BB)  
FWHM 144.0 + 176.0°  
Efficiency %  
LEDs/each optic 1  
Light colour White  
Required components:

### GENERAL INFORMATION:

NOTE: The typical beam angle will be changed by different color, chip size and chip position tolerance. The typical total beam angle is the full angle measured where the luminous intensity is half of the peak value.

### MATERIALS:

As part of our continuous research and improvement processes, and to ensure the best possible quality and availability of our products, LEDiL reserves the right to change material grades without notice.

### PRODUCT DATA USER AGREEMENT AND DISCLAIMER:

The measured data in the provided downloadable LEDiL Product Datasheets and Mechanical 2D-Drawings is rounded and provided as reference for planning. LEDiL Oy's optical specifications have been verified by conducting performance testing of the products in accordance with the company's quality system. The reported data are averaged results of multiple measurements with typical variation. LEDiL Oy reserves the right to without prior notification make changes and improvements to its products.

LEDiL Oy assumes neither warranty, nor guarantee nor any other liability of any kind for the contents and correctness of the provided data. The provided data has been generated with highest diligence but the provided data may in reality not represent the complete possible variation range of all intrinsic parameters. Therefore, in certain cases a deviation from the provided data could occur.

LEDiL Oy reserves the right to undertake technical changes of its products without further notification which could lead to changes in the provided data. LEDiL Oy assumes no liability of any kind for the possible deviation from any provided data or any other damage resulting from the usage of the provided data.

The user agrees to this disclaimer and user agreement with the download or usage of the provided files.

#### LEDiL Oy

Joensuunkatu 13  
FI-24240 SALO  
Finland

#### LEDiL Inc.

228 West Page Street  
Suite D  
Sycamore IL 60178  
USA

#### Local sales and technical support

[www.ledil.com/  
where\\_to\\_buy](http://www.ledil.com/where_to_buy)

#### Shipping locations

Salo, Finland  
Hong Kong, China

#### Distribution Partners

[www.ledil.com/  
where\\_to\\_buy](http://www.ledil.com/where_to_buy)