

LOC	DIST	REVISIONS					
E	B	P	LTR	DESCRIPTION	DATE	DWN	APVD
			BA	NEW RELEASE	10-NOV-08	SM	St.P

FOR FURTHER INFORMATION SEE DATA SHEET FOR  
CRG SERIES-THICK FILM CHIP RESISTORS

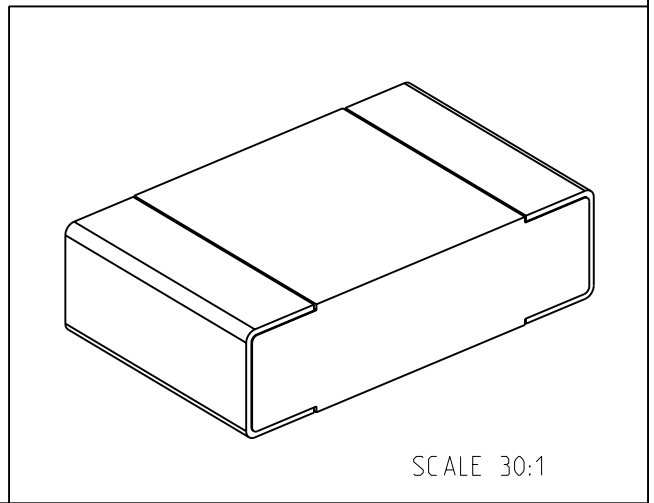
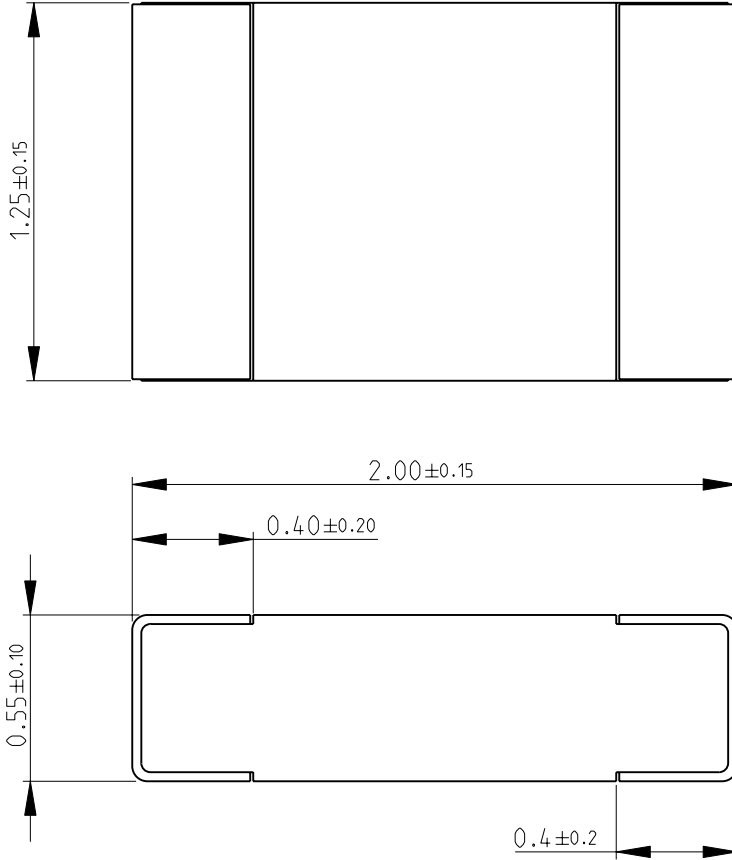

RoHS Compliant

SCALE 30:1

2008

RELEASED FOR PUBLICATION

THIS DRAWING IS UNPUBLISHED.

© COPYRIGHT 2008 BY TYCO ELECTRONICS CORPORATION. ALL RIGHTS RESERVED.

DIMENSIONS: mm	DWN	10-NOV-08	MATERIAL	-	FINISH	-
	CHK	10-NOV-08	Tyco Electronics Corporation Dorcan, Swindon, SN3 5HH			
TOLERANCES UNLESS OTHERWISE SPECIFIED:	APVD	10-NOV-08				
	0 PLC	±0.5	NAME	THICK FILM CHIP RESISTORS SERIES CRG 0805		
1 PLC	±0.2	PRODUCT SPEC	SIZE	CAGE CODE	DRAWING NO	RESTRICTED TO
2 PLC	±0.1	APPLICATION SPEC	A 4	00779	© = 1623097	-
3 PLC	± -	WEIGHT	CUSTOMER DRAWING			
4 PLC	± -		SCALE	40:1	SHEET	1 OF 1
ANGLES	±5°		REV BA			