



The Infinite Bandwidth Company™

MIC5246

150mA μ Cap CMOS LDO Regulator

Final Information

General Description

The MIC5246 is an efficient, precise CMOS voltage regulator optimized for low-noise applications. The MIC5246 offers better than 1% initial accuracy, extremely-low-dropout voltage (typically 150mV at 150mA) and constant ground current (typically 85 μ A) over load. The MIC5246 features an error flag that indicates an output fault condition such as overcurrent, thermal shutdown and dropout. The MIC5246 provides a very low noise output, ideal for RF applications where quiet voltage sources are required.

Designed specifically for hand-held and battery-powered devices, the MIC5246 provides a TTL-logic-compatible enable pin. When disabled, power consumption drops nearly to zero.

The MIC5246 also works with low-ESR ceramic capacitors, reducing the amount of board space necessary for power applications, critical in hand-held wireless devices.

Key features include current limit, thermal shutdown, a push-pull output for faster transient response, and an active clamp to speed up device turnoff. Available in the IttyBitty™ SOT-23-5 package, the MIC5246 also offers a range of fixed output voltages.

Features

- Error flag indicates fault condition
- Ultralow dropout—100mV @ 100mA
- Load independent, ultralow ground current: 85 μ A
- 150mA output current
- Current limiting
- Thermal Shutdown
- Tight load and line regulation
- “Zero” off-mode current
- Stability with low-ESR capacitors
- Fast transient response
- TTL-Logic-controlled enable input

Applications

- Cellular phones and pagers
- Cellular accessories
- Battery-powered equipment
- Laptop, notebook, and palmtop computers
- PCMCIA V_{CC} and V_{PP} regulation/switching
- Consumer/personal electronics
- SMPS post-regulator/dc-to-dc modules
- High-efficiency linear power supplies

Ordering Information

Part Number	Marking	Voltage	Junction Temp. Range	Package
MIC5246-2.6BM5	LT26	2.6V	-40°C to +125°C	SOT-23-5
MIC5246-2.7BM5	LT27	2.7V	-40°C to +125°C	SOT-23-5
MIC5246-2.8BM5	LT28	2.8V	-40°C to +125°C	SOT-23-5
MIC5246-2.85BM5	LT2J	2.85V	-40°C to +125°C	SOT-23-5
MIC5246-3.0BM5	LT30	3.0V	-40°C to +125°C	SOT-23-5
MIC5246-3.3BM5	LT33	3.3V	-40°C to +125°C	SOT-23-5

Other voltages available. Contact Micrel for details.

Typical Application

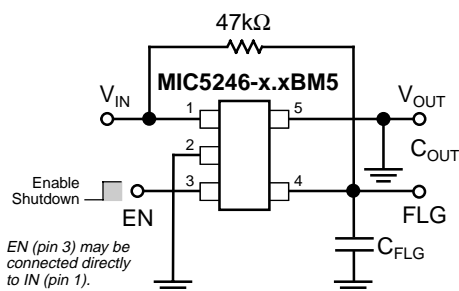

Low-Noise Regulator Application

IttyBitty is a trademark of Micrel, Inc.

Micrel, Inc. • 1849 Fortune Drive • San Jose, CA 95131 • USA • tel + 1 (408) 944-0800 • fax + 1 (408) 944-0970 • http://www.micrel.com

Pin Configuration

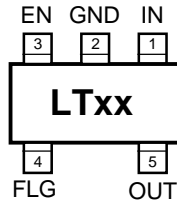

MIC5246-x.xBM5

Pin Description

Pin Number	Pin Name	Pin Function
1	IN	Supply Input
2	GND	Ground
3	EN	Enable/Shutdown (Input): CMOS compatible input. Logic high = enable; logic low = shutdown. Do not leave open.
4	FLG	Error Flag (Output): Open-drain output. Active low indicates an output undervoltage condition.
5	OUT	Regulator Output

Absolute Maximum Ratings (Note 1)

Supply Input Voltage (V_{IN})	0V to +7V
Enable Input Voltage (V_{EN})	0V to V_{IN}
Flag Output Voltage (V_{FLG})	0V to V_{IN}
Junction Temperature (T_J)	+150°C
Storage Temperature	-65°C to +150°C
Lead Temperature (soldering, 5 sec.)	260°C

ESD, **Note 3**

Operating Ratings (Note 2)

Input Voltage (V_{IN})	+2.7V to +6V
Enable Input Voltage (V_{EN})	0V to V_{IN}
Flag Output Voltage (V_{FLG})	0V to V_{IN}
Junction Temperature (T_J)	-40°C to +125°C
Thermal Resistance (θ_{JA})	235°C/W

Electrical Characteristics

$V_{IN} = V_{OUT} + 1V$, $V_{EN} = V_{IN}$; $I_{OUT} = 100\mu A$; $T_J = 25^\circ C$, **bold** values indicate $-40^\circ C \leq T_J \leq +125^\circ C$; unless noted.

Symbol	Parameter	Conditions	Min	Typical	Max	Units
V_O	Output Voltage Accuracy	$I_{OUT} = 0mA$	-1		1	%
			-2		2	%
ΔV_{LNR}	Line Regulation	$V_{IN} = V_{OUT} + 0.1V$ to 6V	-0.3	0	0.3	%/V
ΔV_{LDR}	Load Regulation	$I_{OUT} = 0.1mA$ to 150mA, Note 4		2	3	%
$V_{IN} - V_{OUT}$	Dropout Voltage, Note 5	$I_{OUT} = 100\mu A$		1.5	5	mV
		$I_{OUT} = 50mA$		50	85	mV
		$I_{OUT} = 100mA$		100	150	mV
		$I_{OUT} = 150mA$		150	200 250	mV mV
I_Q	Quiescent Current	$V_{EN} \leq 0.4V$ (shutdown)		0.2	1	μA
I_{GND}	Ground Pin Current, Note 6	$I_{OUT} = 0mA$		85	150	μA
		$I_{OUT} = 150mA$		85	150	μA
PSRR	Power Supply Rejection	$f = 120Hz$, $C_{OUT} = 10\mu F$		50		dB
I_{LIM}	Current Limit	$V_{OUT} = 0V$	160	300		mA

Enable Input

V_{IL}	Enable Input Logic-Low Voltage	$V_{IN} = 2.7V$ to 5.5V, regulator shutdown		0.8	0.4	V
V_{IH}	Enable Input Logic-High Voltage	$V_{IN} = 2.7V$ to 5.5V, regulator enabled	1.6	1		V
I_{EN}	Enable Input Current	$V_{IL} \leq 0.4V$		0.01		μA
		$V_{IH} \geq 1.6V$		0.01		μA
	Shutdown Resistance Discharge			500		Ω

Thermal Protection

	Thermal Shutdown Temperature			150		$^\circ C$
	Thermal Shutdown Hysteresis			10		$^\circ C$

Error Flag

V_{FLG}	Low Threshold	% of V_{OUT} (Flag ON)	90			%
	High Threshold	% of V_{OUT} (Flag OFF)			96	%
V_{OL}	Output Logic-Low Voltage	$I_L = 100\mu A$, fault condition		0.02	0.4	V
I_{FL}	Flag Leakage Current	flag off, $V_{FLG} = 6V$		0.01		μA

Note 1. Exceeding the absolute maximum rating may damage the device.

Note 2. The device is not guaranteed to function outside its operating rating.

Note 3. Devices are ESD sensitive. Handling precautions recommended.

Note 4. Regulation is measured at constant junction temperature using low duty cycle pulse testing. Parts are tested for load regulation in the load range from 0.1mA to 150mA. Changes in output voltage due to heating effects are covered by the thermal regulation specification.

Note 5. Dropout voltage is defined as the input to output differential at which the output voltage drops 2% below its nominal value measured at 1V differential. For outputs below 2.7V, dropout voltage is the input-to-output voltage differential with the minimum input voltage 2.7V. Minimum input operating voltage is 2.7V.

Note 6. Ground pin current is the regulator quiescent current. The total current drawn from the supply is the sum of the load current plus the ground pin current.

Note 7. The error flag is a function of the output voltage being 5% low and the detection of one of the following: overcurrent, overtemperature or dropout. See "Applications Information" section for additional information.

Typical Characteristics

Power Supply Rejection Ratio

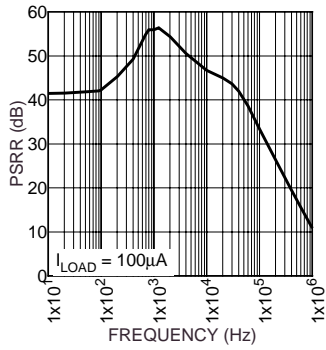

Power Supply Rejection Ratio

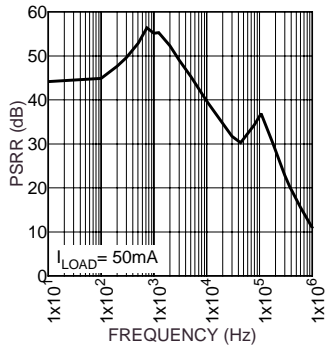

Power Supply Rejection Ratio

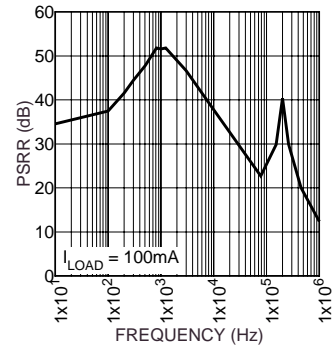

Power Supply Rejection Ratio

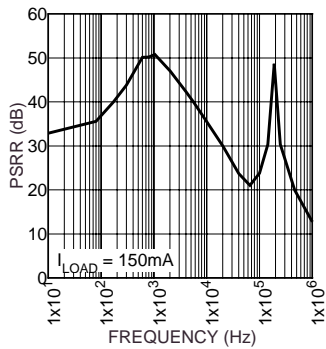

Ground Current vs. Output Current

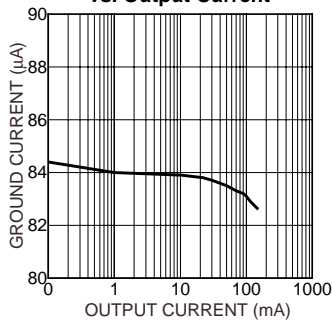

Ground Pin Current

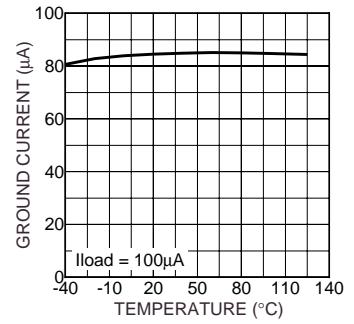

Ground Pin Current

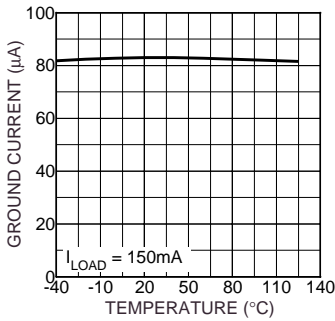

Ground Pin Current

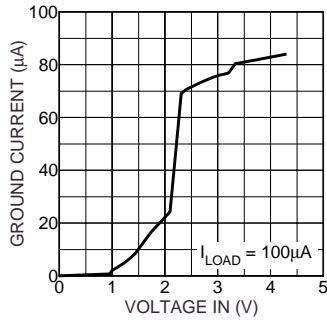

Ground Pin Current

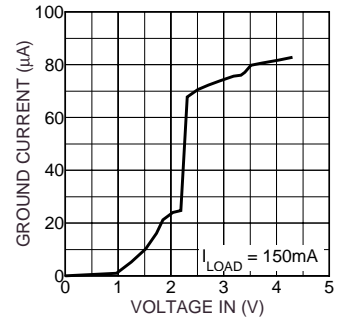

Dropout Characteristics

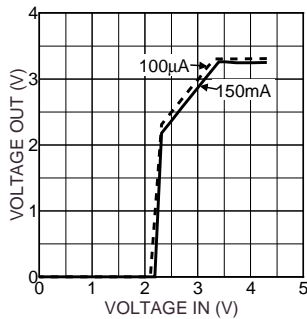

Dropout Voltage

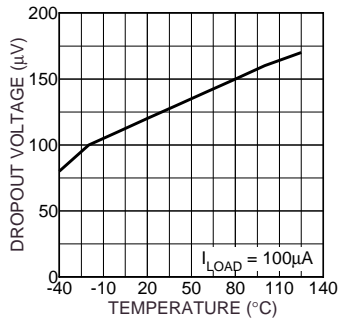

Dropout Voltage

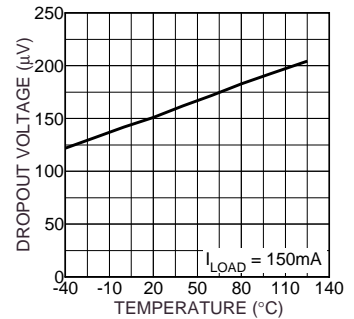

Typical Characteristics

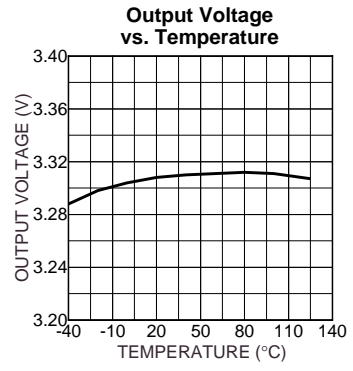
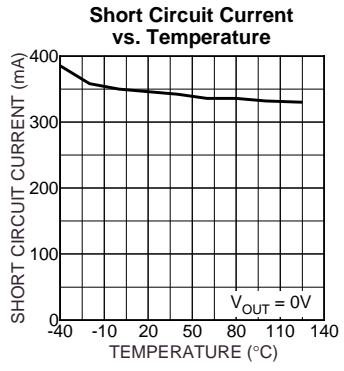

Block Diagrams

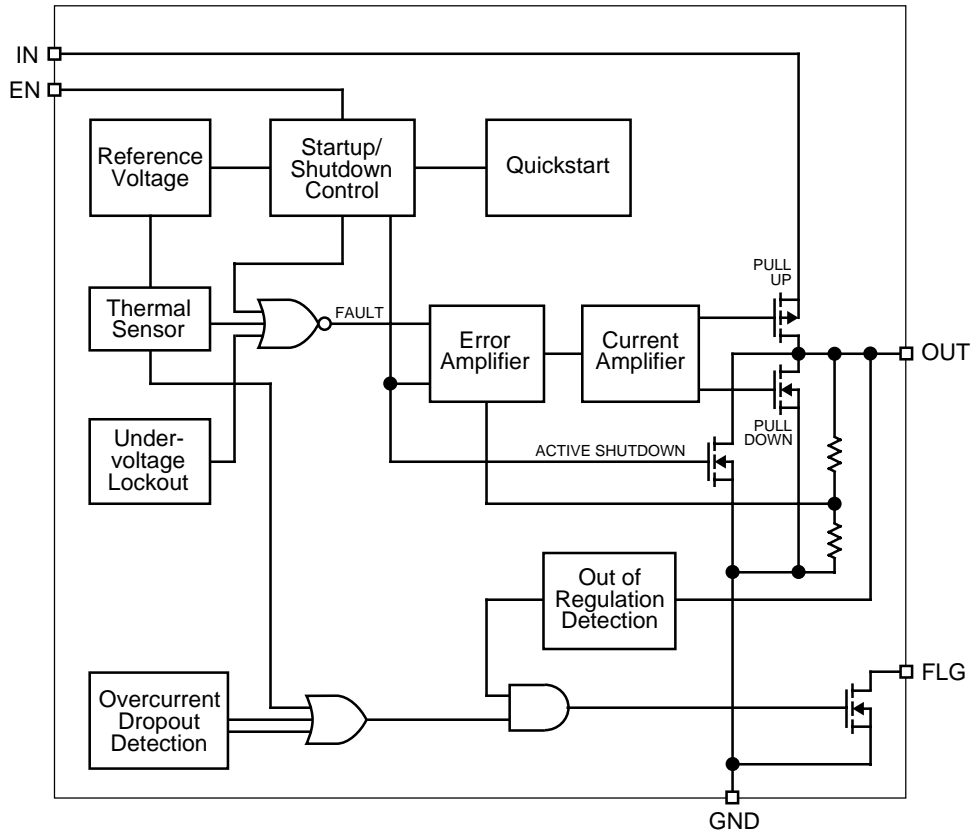

Applications Information

Enable/Shutdown

The MIC5246 comes with an active-high enable pin that allows the regulator to be disabled. Forcing the enable pin low disables the regulator and sends it into a “zero” off-mode-current state. In this state, current consumed by the regulator goes nearly to zero. Forcing the enable pin high enables the output voltage. This part is CMOS and the enable pin cannot be left floating; a floating enable pin may cause an indeterminate state on the output.

Input Capacitor

An input capacitor is not required for stability. A 1 μ F input capacitor is recommended when the bulk ac supply capacitance is more than 10 inches away from the device, or when the supply is a battery.

Output Capacitor

The MIC5246 requires an output capacitor for stability. The design requires 1 μ F or greater on the output to maintain stability. The capacitor can be a low-ESR ceramic chip capacitor. The MIC5246 has been designed to work specifically with the low-cost, small chip capacitors. Tantalum capacitors can also be used for improved capacitance over temperature. The value of the capacitor can be increased without bound.

X7R dielectric ceramic capacitors are recommended because of their temperature performance. X7R-type capacitors change capacitance by 15% over their operating temperature range and are the most stable type of ceramic capacitors. Z5U and Y5V dielectric capacitors change value by as much 50% and 60% respectively over their operating temperature ranges. To use a ceramic chip capacitor with Y5V dielectric, the value must be much higher than an X7R ceramic or a tantalum capacitor to ensure the same minimum capacitance value over the operating temperature range. Tantalum capacitors have a very stable dielectric (10% over their operating temperature range) and can also be used with this device.

Error Flag

The error flag output is an active-low, open-drain output that drives low when a fault condition AND an undervoltage detection occurs. Internal circuitry intelligently monitors overcurrent, overtemperature and dropout conditions and ORs these outputs together to indicate some fault condition. The output of that OR gate is ANDed with an output voltage monitor that detects an undervoltage condition. That output drives the open-drain transistor to indicate a fault. This prevents chattering or inadvertent triggering of the error flag. The error flag must be pulled up using a resistor from the flag pin to either the input or the output.

Error Flag Circuit

The error flag circuit was designed essentially to work with a capacitor to ground to act as a power-on reset generator, signaling a power-good situation once the regulated voltage was up and/or out of a fault condition. This capacitor delays the error signal from pulling high, allowing the downstream circuits time to stabilize. When the error flag is pulled up to the

input without using a pull-down capacitor, then there can be a glitch on the error flag upon start up of the device. This is due to the response time of the error flag circuit as the device starts up. When the device comes out of the zero off mode current state, all the various nodes of the circuit power up before the device begins supplying full current to the output capacitor. The error flag drives low immediately and then releases after a few microseconds. The intelligent circuit that triggers an error detects the output going into current limit AND the output being low while charging the output capacitor. The error output then pulls low for the duration of the turn-on time. This glitch is filtered by putting a capacitor from the error flag to ground. The glitch does not occur if the error flag pulled up to the output.

Transient Response

The MIC5246 implements a unique output stage to dramatically improve transient response recovery time. The output is a totem-pole configuration with a P-channel MOSFET pass device and an N-channel MOSFET clamp. The N-channel clamp is a significantly smaller device that prevents the output voltage from overshooting when a heavy load is removed. This feature helps to speed up the transient response by significantly decreasing transient response recovery time during the transition from heavy load (100mA) to light load (85 μ A).

Active Shutdown

The MIC5246 also features an active shutdown clamp, which is an N-channel MOSFET that turns on when the device is disabled. This allows the output capacitor and load to discharge, de-energizing the load.

Thermal Considerations

The MIC5246 is designed to provide 150mA of continuous current in a very small package. Maximum power dissipation can be calculated based on the output current and the voltage drop across the part. To determine the maximum power dissipation of the package, use the junction-to-ambient thermal resistance of the device and the following basic equation:

$$P_{D(\max)} = \left(\frac{T_{J(\max)} - T_A}{\theta_{JA}} \right)$$

$T_{J(\max)}$ is the maximum junction temperature of the die, 125°C, and T_A is the ambient operating temperature. θ_{JA} is layout dependent; Table 1 shows examples of junction-to-ambient thermal resistance for the MIC5246.

Package	θ_{JA} Recommended Minimum Footprint	θ_{JA} 1" Square Copper Clad	θ_{JC}
SOT-23-5 (M5)	235°C/W	185°C/W	145°C/W

Table 1. SOT-23-5 Thermal Resistance

The actual power dissipation of the regulator circuit can be determined using the equation:

$$P_D = (V_{IN} - V_{OUT}) I_{OUT} + V_{IN} I_{GND}$$

Substituting $P_{D(max)}$ for P_D and solving for the operating conditions that are critical to the application will give the maximum operating conditions for the regulator circuit. For example, when operating the MIC5246-3.0BM5 at 50°C with a minimum footprint layout, the maximum input voltage for a set output current can be determined as follows:

$$P_{D(max)} = \left(\frac{125^\circ\text{C} - 50^\circ\text{C}}{235^\circ\text{C/W}} \right)$$

$$P_{D(max)} = 315\text{mW}$$

The junction-to-ambient thermal resistance for the minimum footprint is 235°C/W, from Table 1. The maximum power dissipation must not be exceeded for proper operation. Using the output voltage of 3.0V and an output current of 150mA, the maximum input voltage can be determined. Because this device is CMOS and the ground current is typically 100µA over the load range, the power dissipation contributed by the ground current is < 1% and can be ignored for this calculation.

$$315\text{mW} = (V_{IN} - 3.0\text{V}) 150\text{mA}$$

$$315\text{mW} = V_{IN} \cdot 150\text{mA} - 450\text{mW}$$

$$810\text{mW} = V_{IN} \cdot 150\text{mA}$$

$$V_{IN(max)} = 5.4\text{V}$$

Therefore, a 3.0V application at 150mA of output current can accept a maximum input voltage of 5.4V in a SOT-23-5 package. For a full discussion of heat sinking and thermal effects on voltage regulators, refer to the Regulator Thermals section of Micrel's *Designing with Low-Dropout Voltage Regulators* handbook.

Fixed Regulator Applications

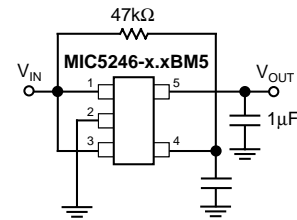

Figure 1. Low-Noise Fixed Voltage Application

Figure 1 shows a standard low-noise configuration with a 47kΩ pull-up resistor from the error flag to the input voltage and a pull-down capacitor to ground for the purpose of fault indication.

Dual-Supply Operation

When used in dual supply systems where the regulator load is returned to a negative supply, the output voltage must be diode clamped to ground.

Package Information

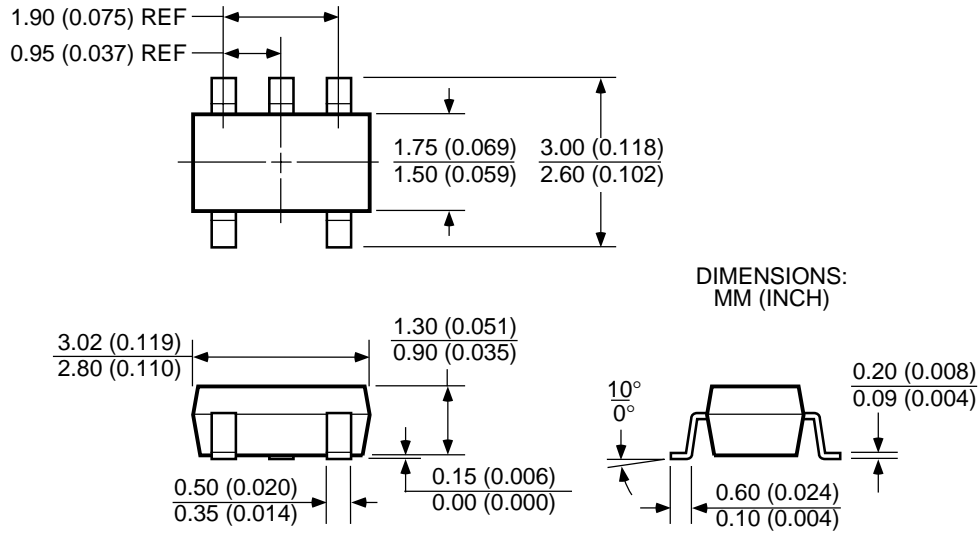

SOT-23-5 (M)

MICREL INC. 1849 FORTUNE DRIVE SAN JOSE, CA 95131 USA

TEL + 1 (408) 944-0800 FAX + 1 (408) 944-0970 WEB <http://www.micrel.com>

This information is believed to be accurate and reliable, however no responsibility is assumed by Micrel for its use nor for any infringement of patents or other rights of third parties resulting from its use. No license is granted by implication or otherwise under any patent or patent right of Micrel Inc.

© 2000 Micrel Incorporated



Поставка электронных компонентов

Юридический адрес организации:
198099, г. Санкт-Петербург, ул. Калинина, дом 2, кор. 4, лит А.
Фактический адрес организации:
198099, г. Санкт-Петербург, ул. Калинина, дом 2, кор. 4, лит А.
ИНН 780277764
КПП 780501001
Р/С 40702810422510004035 ФАКБ "АБСОЛЮТ БАНК" (ЗАО) в Санкт-Петербурге К/С 30101810900000000703
БИК 044030703
Телефон: 8 (812) 309-44-11 (многоканальный)
Факс: 8 (812) 309-44-11
Электронная почта: sales@timechips.ru
Сайт: timechips.ru

Информационное письмо

Компания «ТаймЧипс» - одна из наиболее динамично развивающихся компаний в сфере поставок электронных компонентов. Мы поставляем широкую номенклатуру электронных компонентов отечественных и импортных производителей, как напрямую, так и с крупных мировых складов, позволяющих охватить выборочную номенклатуру более 300 брендов, а также специализируемся на поставках дисплеев и является официальным дистрибьютором компании Shenzhen Startek Electronic Technology Co, на территории Российской Федерации.

Наличие собственной логистики позволяет в кратчайшие сроки доставлять товар нашим клиентам. В нашей компании имеется Конструкторский отдел, где наши специалисты проводят технические консультации клиентов, квалифицированную поддержку и помощь российским разработчикам. Осуществляем Поставки импортной продукции под контролем ВП МО РФ, на предприятия Оборонно-промышленного комплекса России. Система менеджмента качества компании соответствует требованиям ГОСТ ISO 9001-2011.

Благодаря нацеленности на результат, мы уверенно занимаем новые позиции на рынке, заинтересовывая Клиента не только актуальными ценами и гибким подходом, но и постоянным вниманием.

Миссия – обеспечение долгосрочного и взаимовыгодного партнерства с клиентами.

Наша цель – Обеспечение клиентам самого широкого ассортимента электронных компонентов и бесперебойности поставок.

Мы - это развитие! Мы задаем темп! Мы разные, но вместе! Мы работаем для вас!

Так же имеем прямые поставки от производителей:

TAI-SAW Пав-компоненты (www.taisaw.com)

TRANSCOM СВЧ-компоненты (www.transcominc.com.tw)

Mini Circuits ВЧ-СВЧ-компоненты (minicircuits.com)

SAMTEC- разъемы (www.samtec.com)

4Star Разъемы РЧ (Даташиты по продукции 4Star, которые Вы сможете загрузить по этой ссылке: <https://yadi.sk/i/tPjnmGGrpmbYj>)

ULNION Преобразователи напряжения (converterdc.com/)

Отличные рекомендации на рынке, уверенность в качестве поставляемой продукции делают нас надежными партнерами для наших клиентов.

«ТаймЧипс» - это:

- Гарантия качества поставляемой продукции;
- Широкий ассортимент;
- Минимальные сроки поставок;
- Техническая поддержка;
- Подбор комплектации;
- Индивидуальный подход;
- Гибкие цены.

Модули, микросхемы, пассивные компоненты, Xilinx (XC), Altera (EP,EPF, EPM) и силовая электроника – это наши ведущие позиции, на поставку которых мы гарантированно дадим Вам самые выгодные предложения!

В структуру компании так же входит конструкторский отдел, который помогает разработчикам и конструкторам в решении следующих задач:

- Оценка стоимости проекта по компонентам;
- Подбор оптимального решения при выборе компонента;
- Подбор аналогов;
- Техническая поддержка;
- Консультации у производителей;
- Поставка прототипов;

С Уважением, Чернов Павел.

Руководитель отдела продаж ООО "ТАЙМЧИПС"

Официальный дистрибьютор Shenzhen Startek Electronic Technology Co.,Ltd в России (USB Display Modules , LED Displays, Serial Modules).

<http://www.timechips.ru/>

<http://lcd-timechips.ru/>

Телефон: +7 (812) 309-44-11 доб. 141

Факс: +7 (812) 309-44-11 доб. 152

Моб. Тел. +7 (905) 232-40-65

Skype: time.chips5

Электронная почта: manager1@timechips.ru
