

V.92 AND V.34 ISOMODEM[®] WITH GLOBAL DAA

Features

- Data modem formats
 - ITU-T, Bell
 - 300 bps up to 56 kbps
 - V.21, V.22, V.29 Fast Connect
 - V.44, V.42, V.42bis, MNP2-5
 - Automatic rate negotiation
 - V.92 PCM upstream
 - V.92 Quick connect
 - V.92 Modem on hold
 - Type I and II caller ID decode
 - No external ROM or RAM required
 - UART, SPI, or parallel interface
 - Flexible clock options
 - Low-cost 32.768 kHz oscillator
 - 4.915 MHz oscillator
 - 27 MHz clock input
 - Integrated DAA
 - Over 6000 V capacitive isolation
 - Parallel phone detect
 - Globally-compliant line interface
 - Overcurrent detection
 - AT command set support
 - SMS / MMS support
 - Firmware upgradeable
- EEPROM interface
 - Commercial or industrial temperature range
 - DTMF detection/generation
 - Si3000 Voice Codec Interface
 - Hardware support for mic, speaker, and/or handset
 - Programmable voice filters, limiters, and sidetone
 - Supports TBR-38, TIA/EIA-4790 and other voice standards
 - Voice pass through with compression
 - Supports telephone answering machine, music on hold, voice menus, etc
 - Full-duplex speakerphone support
 - Line echo cancellation
 - Acoustic echo cancellation

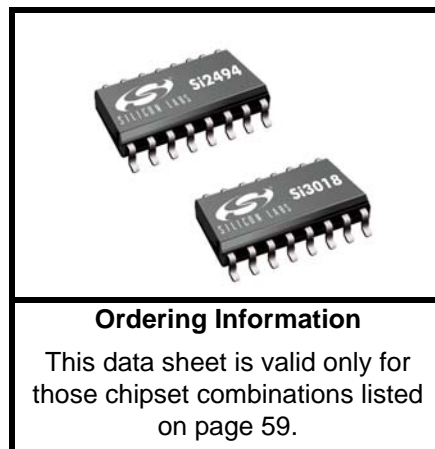

Applications

- Point-of-sale terminals
- Security
- Medical
- Remote monitoring

Description

The Si2494/39 ISOModem is a full-featured ITU V.92/V.34-compliant modem that provides connect rates of up to 56 kbps, full-duplex, over the public switched telephone network (PSTN). Offered as a chipset with the Si2494/39 system-side device and the Si3018 line-side device, the ISOModem utilizes Silicon Laboratories' patented direct access arrangement (DAA) technology to provide a programmable telephone line interface with an unparalleled level of integration. This compact solution eliminates the need for a separate DSP, modem controller, codec, transformer, relay, opto-isolators, clocking crystal, and 2-4 wire hybrid. The addition of the Si3000 voice codec supports a voice handset and/or full-duplex speakerphone. Voice pass-through with optional compression supports tapeless answering machine, music-on-hold, voice menus, etc. The Si2494/39 is ideal for embedded modem applications due to its flexibility, small footprint, and minimal external component count.

System Block Diagram

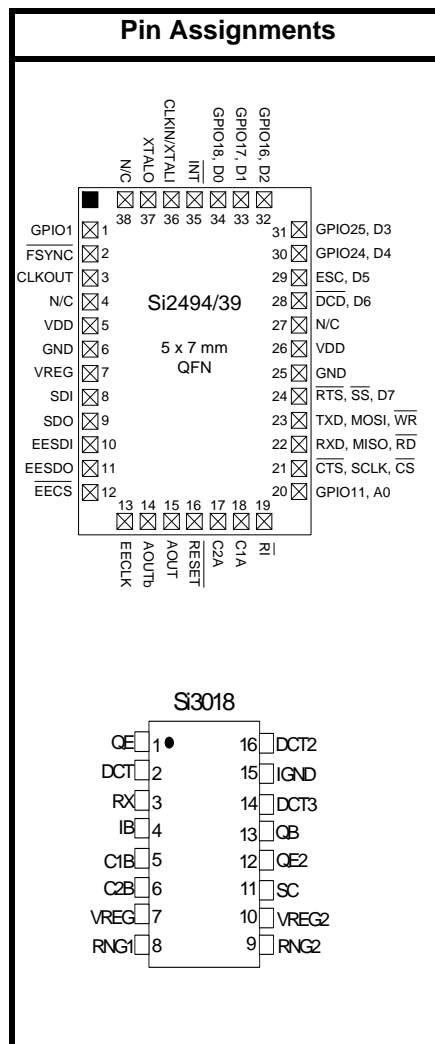

TABLE OF CONTENTS

<u>Section</u>	<u>Page</u>
1. Electrical Specifications	5
2. Typical Application Schematic	12
3. Bill of Materials: Si2494/39 Chipset	13
4. Functional Description	18
4.1. Host Interface	19
4.2. Command Mode	20
4.3. Data Mode	20
4.4. Fast Connect	20
4.5. V.80 Synchronous Access Mode	20
4.6. Voice Mode (+FCLASS=8)	20
4.7. Clocking	20
4.8. Low-Power Modes	21
4.9. Data Compression	21
4.10. Error Correction	21
4.11. Wire Mode	21
4.12. V.92 PCM Upstream	22
4.13. V.92 Quick Connect	22
4.14. V.92 Modem-on-Hold	22
4.15. Caller ID Operation	23
4.16. Parallel Phone Detection	23
4.17. Overcurrent Detection	24
4.18. Global Operation	24
4.19. Firmware Upgrades	24
4.20. DTMF Detection / Generation	24
4.21. SMS/MMS Support	25
4.22. Codec Interface	25
4.23. Answering Machine Support	25
4.24. Voice Pass-Through (Speakerphone)	25
4.25. General-Purpose Tone Detectors	25
4.26. EEPROM Interface	26
4.27. AT Commands	26
4.28. Extended AT Commands	41
5. S-Registers	51
6. User-Access Registers (U-Registers)	54
7. Pin Descriptions: Si2494/39	55
8. Pin Descriptions: Si3018	58
9. Ordering Guide	59
10. Package Markings (Top Markings)	60
10.1. Si2494 Top Marking	60
10.2. Si2439 Top Marking	60
10.3. Si2494/39 Top Markings Explanation	61
10.4. Si3018 Top Marking	62
10.5. Si3018 Top Markings Explanation	62

Si2494/39

- 11. Package Outline: 38-Pin QFN63
- 12. 38-Pin QFN Land Pattern65
- 13. Package Outline: 16-Pin SOIC66
- 14. 16-Pin SOIC Land Pattern68
- Contact Information70



1. Electrical Specifications

Table 1. Recommended Operating Conditions

Parameter ¹	Symbol	Test Condition	Min ²	Typ	Max ²	Unit
Ambient Temperature	T_A	F-grade G-grade	0 -40	25 25	70 85	°C
Si2494/39 Supply Voltage, Digital ³	V_D		3.0	3.3	3.6	V

Notes:

- The Si2494/39 specifications are guaranteed when the typical application circuit (including component tolerance) and any Si2494/39 and any Si3018 are used. See "2. Typical Application Schematic" on page 12.
- All minimum and maximum specifications are guaranteed and apply across the recommended operating conditions. Typical values apply at nominal supply voltages and an operating temperature of 25 °C unless otherwise stated.
- The digital supply, V_D , operates from 3.0 to 3.6 V.

Figure 1. Test Circuit for Loop Characteristics

Table 2. DC Characteristics, $V_D = 3.0$ to 3.6 V

($V_D = 3.0$ to 3.6 V, $T_A = 0$ to 70 °C for F-grade, $T_A = -40$ to 85 °C for G-grade)

Parameter	Symbol	Test Condition	Min	Typ	Max	Unit
High Level Input Voltage	V_{IH}		2.0	—	—	V
Low Level Input Voltage	V_{IL}		—	—	0.8	V
High Level Output Voltage	V_{OH}	$I_O = -2$ mA	2.4	—	—	V
Low Level Output Voltage	V_{OL}	$I_O = 2$ mA	—	—	0.35	V
Input Leakage Current	I_L		-10	—	10	μA
Pullup Resistance Pins	R_{PU}		50	125	200	kΩ
Total Supply Current*	I_D		—	17	35	mA
Total Supply Current, Wake-On-Ring*	I_D		—	4.4	—	mA
Total Supply Current, Powerdown*	I_D	PDN = 1	—	80	—	μA

***Note:** All inputs at 0 or V_D . All inputs held static except clock and all outputs unloaded (Static $I_{OUT} = 0$ mA).

Table 3. AC Characteristics

($V_D = 3.0$ to 3.6 V, $T_A = 0$ to 70 °C for F-grade, $F_s = 8$ kHz, $T_A = -40$ to 85 °C for G-grade)

Parameter	Symbol	Test Condition	Min	Typ	Max	Unit
Sample Rate	F_s		—	8	—	kHz
Clock Input Frequency	F_{XTL}	default	—	4.9152	—	MHz
Clock Input Frequency	F_{XTL}	27 MHz Mode ¹	—	27	—	MHz
Clock Input Frequency	F_{XTL}	32 kHz Mode ¹	—	32.768	—	kHz
Receive Frequency Response		Low -3 dBFS Corner, FILT = 0	—	5	—	Hz
Receive Frequency Response		Low -3 dBFS Corner, FILT = 1	—	200	—	Hz
Transmit Full Scale Level ²	V_{FS}		—	1.1	—	V_{PEAK}
Receive Full Scale Level ^{2,3}	V_{FS}		—	1.1	—	V_{PEAK}
Dynamic Range ⁴	DR	ILIM = 0, DCV = 11, MINI = 00 DCR = 0, $I_L = 100$ mA	—	80	—	dB
Dynamic Range ⁴	DR	ILIM = 0, DCV = 00, MINI = 11 DCR = 0, $I_L = 20$ mA	—	80	—	dB
Dynamic Range ⁴	DR	ILIM = 1, DCV = 11, MINI = 00 DCR = 0, $I_L = 50$ mA	—	80	—	dB
Transmit Total Harmonic Distortion ⁵	THD	ILIM = 0, DCV = 11, MINI = 00 DCR = 0, $I_L = 100$ mA	—	-72	—	dB
Transmit Total Harmonic Distortion ⁵	THD	ILIM = 0, DCV = 00, MINI = 11 DCR = 0, $I_L = 20$ mA	—	-78	—	dB
Receive Total Harmonic Distortion ⁵	THD	ILIM = 0, DCV = 00, MINI = 11 DCR = 0, $I_L = 20$ mA	—	-78	—	dB
Receive Total Harmonic Distortion ⁵	THD	ILIM = 1, DCV = 11, MINI = 00 DCR = 0, $I_L = 50$ mA	—	-78	—	dB
Dynamic Range (Caller ID Mode)	DR _{CID}	VIN = 1 kHz, -13 dBm	—	50	—	dB

Notes:

1. Refer to “AN93: ISModem® Chipset Family Designer's Guide” for configuring clock input reset strapping.
2. Measured at TIP and RING with 600 Ω termination at 1 kHz, as shown in Figure 1 on page 5.
3. Receive full scale level produces -0.9 dBFS at DTX.
4. DR = $20 \times \log |V_{in}| + 20 \times \log (\text{rms signal/rms noise})$. Applies to both transmit and receive paths. $V_{in} = 1$ kHz, -3 dBFS.
5. $V_{in} = 1$ kHz, -3 dBFS. THD = $20 \times \log (\text{rms distortion/rms signal})$.

Table 4. Loop Characteristics(V_D = 3.0 to 3.6 V, T_A = 0 to 70 °C for F-grade, T_A = -40 to 85 °C for G-grade)

Parameter	Symbol	Test Condition	Min	Typ	Max	Unit
DC Termination Voltage	V _{TR}	I _L = 20 mA, ILIM ¹ = 0 DCV = 00, MINI = 11, DCR = 0	—	—	6.0	V
DC Termination Voltage	V _{TR}	I _L = 120 mA, ILIM = 0 DCV = 00, MINI = 11, DCR = 0	9	—	—	V
DC Termination Voltage	V _{TR}	I _L = 20 mA, ILIM = 0 DCV = 11, MINI = 00, DCR = 0	—	—	7.5	V
DC Termination Voltage	V _{TR}	I _L = 120 mA, ILIM = 0 DCV = 11, MINI = 00, DCR = 0	9	—	—	V
DC Termination Voltage	V _{TR}	I _L = 20 mA, ILIM = 1 DCV = 11, MINI = 00, DCR = 0	—	—	7.5	V
DC Termination Voltage	V _{TR}	I _L = 60 mA, ILIM = 1 DCV = 11, MINI = 00, DCR = 0	40	—	—	V
DC Termination Voltage	V _{TR}	I _L = 50 mA, ILIM = 1 DCV = 11, MINI = 00, DCR = 0	—	—	40	V
On-Hook Leakage Current	I _{LK}	V _{TR} = -48 V	—	—	5	μA
Operating Loop Current	I _{LP}	MINI = 00, ILIM = 0	10	—	120	mA
Operating Loop Current	I _{LP}	MINI = 00, ILIM = 1	10	—	60	mA
DC Ring Current		DC current flowing through ring detection circuitry	—	1.5	3	μA
Ring Detect Voltage ²	V _{RD}	RT = 0	12	15	18	V _{RMS}
Ring Detect Voltage ²	V _{RD}	RT = 1	18	21	25	V _{RMS}
Ring Frequency	F _R		15	—	68	Hz
Ringer Equivalence Number	REN		—	—	0.2	

Notes:

1. ILIM = U67, bit 9; DCV = U67, bits 3:2; MINI = U67, bits 13:12; DCR = U67, bit 7; RT = U67, bit 0.
2. The ring signal is guaranteed to not be detected below the minimum. The ring signal is guaranteed to be detected above the maximum.

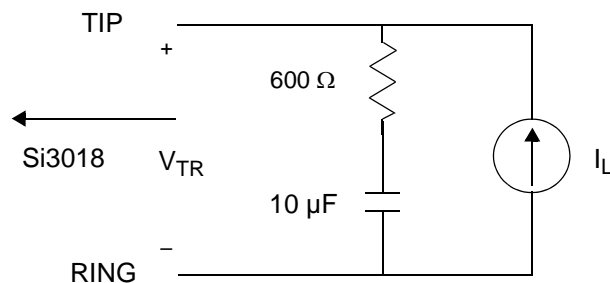

Table 5. Switching Characteristics¹(V_D = 3.0 to 3.6 V, T_A = 0 to 70 °C for F-grade, T_A = -40 to 85 °C for G-grade)

Parameter	Symbol	Min	Typ	Max	Unit
UART Timing Parameters					
CLKOUT Output Clock Frequency		2.048	—	49.152	MHz
Baud Rate Accuracy	t _{BD}	-1	—	1	%
Reset Timing Parameters					
RESET ↓ to RESET ↑	t _{RS}	5.0 ²	—	—	ms
RESET ↑ to 1st AT Command	t _{AT}	300	—	—	ms
Parallel Timing Parameters					
Address Setup	t _{AS}	15	—	—	ns
Address Hold	t _{AH}	0	—	—	ns
WR Low Pulse Width	t _{WL}	50	—	—	ns
Write Data Setup Time	t _{WDSU}	20	—	—	ns
Write Cycle Time	t _{WC}	120	—	—	ns
Chip Select Setup	t _{CSS}	10	—	—	ns
Chip Select Hold	t _{CSH}	0	—	—	ns
RD Low Pulse Width	t _{RL}	50	—	—	ns
RD Low to Data Driven Time	t _{RLDD}	—	—	20	ns
Data Hold	t _{DH}	10	—	—	ns
RD High to Hi-Z Time	t _{DZ}	—	—	30	ns
Read Cycle Time	t _{RC}	120	—	—	ns
Write to Read Cycle Time	t _{WRC}	120	—	—	ns
Serial Peripheral Interface (SPI) Timing Parameters					
SS Falling to First SCLK Edge	t _{SE}	41	—	—	ns
Last SCLK Edge to SS Rising	t _{SD}	41	—	—	ns
SS Rising to MISO High-Z	t _{SDZ}	—	—	93	ns
SCLK High Time	t _{CKH}	102	—	—	ns
SCLK Low Time	t _{CKL}	102	—	—	ns
MOSI Valid to SCLK Sample Edge	t _{SIS}	41	—	—	ns
SCLK Sample Edge to MOSI Change	t _{SIH}	41	—	—	ns
SCLK Shift Edge to MISO Change	t _{SOH}	—	—	93	ns
Notes:					
1. All timing is referenced to the 50% level of the waveform. Input test levels are V _{IH} = V _D - 0.4 V, V _{IL} = 0.4 V.					
2. With 32.768 kHz clocking, allow 500 to the reset low-to-high minimum pulse on power-up and wake-from-power-down conditions.					

Table 5. Switching Characteristics¹ (Continued)(V_D = 3.0 to 3.6 V, T_A = 0 to 70 °C for F-grade, T_A = -40 to 85 °C for G-grade)

Parameter	Symbol	Min	Typ	Max	Unit
SCLK cycle time	t _{SCK}	224	—	—	ns
Inactive time between SS actives	t _{NSS_INACT}	81	—	—	ns

Notes:

- All timing is referenced to the 50% level of the waveform. Input test levels are V_{IH} = V_D - 0.4 V, V_{IL} = 0.4 V.
- With 32.768 kHz clocking, allow 500 to the reset low-to-high minimum pulse on power-up and wake-from-power-down conditions.

Table 6. Thermal Conditions

Parameter	Symbol	Test Condition	Min	Typ	Max	Unit
Thermal Resistance (Si2494/39)	θ _{JA}	QFN-38	—	35	—	°C/W
Thermal Resistance (Si3018)	θ _{JA}	SOIC-16	—	77	—	°C/W
Maximum Junction Temperature (Si2494/39)	T _θ	QFN-38	—	—	105	°C
Maximum Junction Temperature (Si3018)	T _θ	SOIC-16	—	—	110	°C

Table 7. Absolute Maximum Ratings

Parameter	Symbol	Value	Unit
DC Supply Voltage	V _D	4.1	V
Input Current, Si2494/39 Digital Input Pins	I _{IN}	±10	mA
Digital Input Voltage	V _{IND}	-0.3 to (V _D + 0.3)	V
CLKIN/XTALI Input Voltage	V _{XIND}	-0.3 to (V _D + 0.3)	V
Operating Temperature Range	T _A	-10 to 100	°C
Storage Temperature Range	T _{STG}	-40 to 150	°C

Note: Permanent device damage may occur if the above absolute maximum ratings are exceeded. Functional operation should be restricted to the conditions as specified in the operational sections of this data sheet. Exposure to absolute maximum rating conditions for extended periods may affect device reliability.



Figure 2. SPI Slave Timing



Figure 3. Parallel Interface Write Timing



Figure 4. Parallel Interface Write Followed by Read Timing

2. Typical Application Schematic

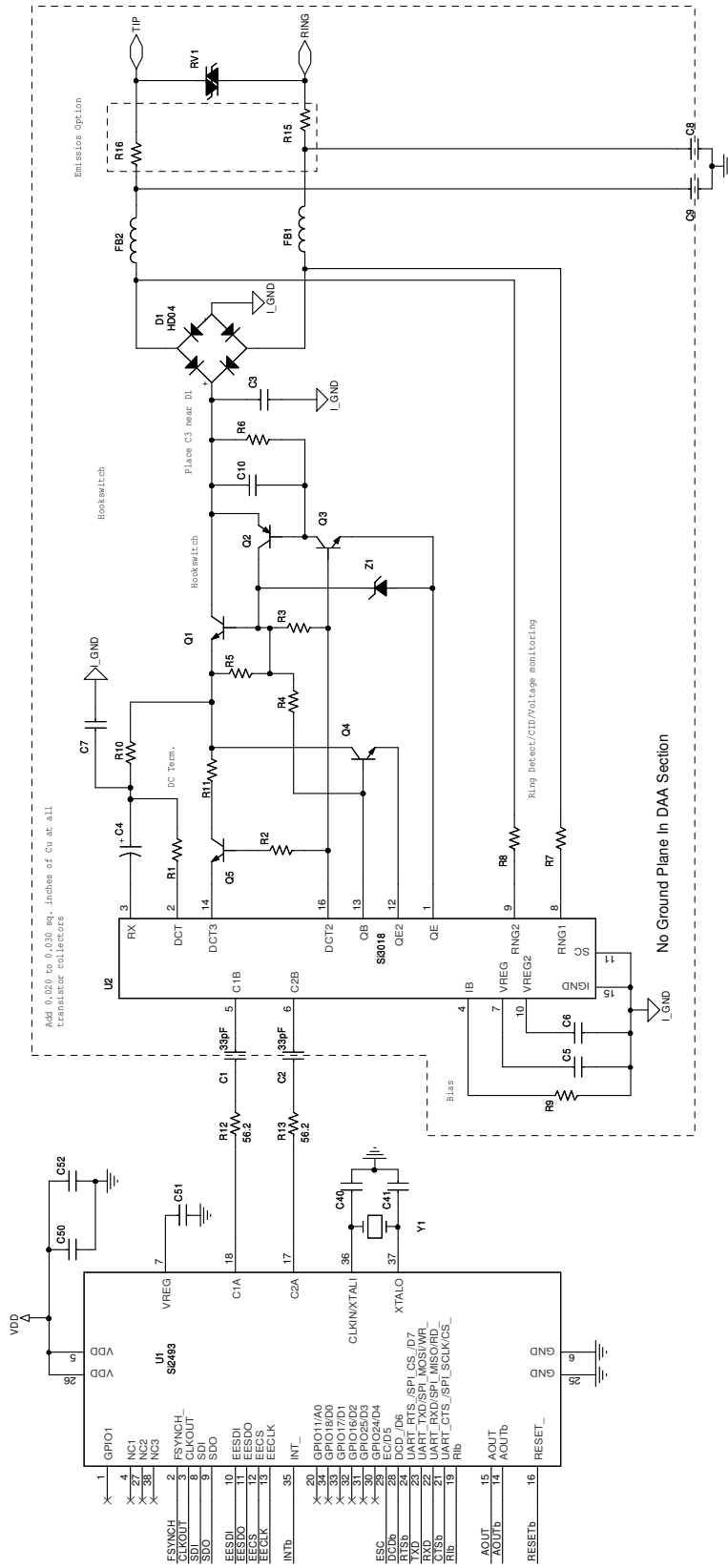

Figure 5. Typical Si2494/39 Schematic

3. Bill of Materials: Si2494/39 Chipset

Component	Value	Supplier(s)
C1, C2	33 pF, Y2, X7R, $\pm 20\%$	Panasonic, Murata, Vishay
C3	10 nF, 250 V, X7R, $\pm 20\%$	Venkel, SMEC
C4	1.0 μ F, 50 V, Elec/Tant, $\pm 20\%$	Panasonic
C5, C6, C50, C52	0.1 μ F, 16 V, X7R, $\pm 20\%$	Venkel, SMEC
C7	2.7 nF, 50 V, X7R, $\pm 20\%$	Venkel, SMEC
C8, C9	680 pF, Y2, X7R, $\pm 10\%$	Panasonic, Murata, Vishay
C10	0.01 μ F, 16 V, X7R, $\pm 20\%$	Venkel, SMEC
C40 C41	32.768 kHz: 18 pF, 16 V, NPO, $\pm 5\%$	Venkel, SMEC
	4.9152 MHz: 33 pF, 16 V, NPO, $\pm 5\%$	
	27 MHz: Not Populated	
C51	0.22 μ F, 16 V, X7R, $\pm 20\%$	Venkel, SMEC
D1, D2 ¹	Dual Diode, 225 mA, 300 V, CMPD2004S	Central Semiconductor
FB1, FB2	Ferrite Bead, BLM21AG601SN1	Murata
Q1, Q3	NPN, 300 V, MMBTA42	OnSemi, Fairchild
Q2	PNP, 300 V, MMBTA92	OnSemi, Fairchild
Q4, Q5	NPN, 80 V, 330 mW, MMBTA06	OnSemi, Fairchild
RV1	Sidactor, 275 V, 100 A	Teccor, Protek, ST Micro
R1	1.07 k Ω , 1/2 W, 1%	Venkel, SMEC, Panasonic
R2	150 Ω , 1/16 W, 5%	Venkel, SMEC, Panasonic
R3	3.65 k Ω , 1/2 W, 1%	Venkel, SMEC, Panasonic
R4	2.49 k Ω , 1/2 W, 1%	Venkel, SMEC, Panasonic
R5, R6	100 k Ω , 1/16 W, 5%	Venkel, SMEC, Panasonic
R7, R8	20 M Ω , 1/16 W, 5%	Venkel, SMEC, Panasonic
R9	1 M Ω , 1/16 W, 1%	Venkel, SMEC, Panasonic
R10	536 Ω , 1/4 W, 1%	Venkel, SMEC, Panasonic
R11	73.2 Ω , 1/2 W, 1%	Venkel, SMEC, Panasonic
R12, R13	56 Ω , 1/16 W, 1%	Venkel, SMEC, Panasonic
R15, R16 ²	0 Ω , 1/16 W	Venkel, SMEC, Panasonic
U1	Si2494/39	Silicon Labs
U2	Si3018	Silicon Labs
Y1 ³	32.768 kHz, 12 pF, 100 ppm, 35 k Ω max ESR	ECS Inc., Siward
	4.9152 MHz, 20 pF, 100 ppm, 150 Ω ESR	
	27 MHz (from external clock)	
Z1	Zener Diode, 43 V, 1/2 W, BZT84C43	On Semi

Notes:

- Several diode bridge configurations are acceptable. For example, a single DF04S or four 1N4004 diodes may be used.
- Murata BLM21AG601SN1 may be substituted for R15–R16 (0 Ω) to decrease emissions.
- To ensure compliance with ITU specifications, frequency tolerance must be less than 100 ppm including initial accuracy, 5-year aging, 0 to 70 °C, and capacitive loading. For optimal V.92 PCM upstream performance, the recommended crystal accuracy is ± 25 ppm.

Table 8. Protocol Characteristics

Item	Specification
Data Rate (downstream) 56 kbps 54.666 kbps 53.333 kbps 52 kbps 50.666 kbps 49.333 kbps 48 kbps 46.666 kbps 45.333 kbps 44 kbps 42.666 kbps 41.333 kbps 40 kbps 38.666 kbps 37.333 kbps 36 kbps 34.666 kbps 33.333 kbps 32 kbps 30.666 kbps 29.333 kbps 28 kbps	ITU-T V.90 ITU-T V.90
Data Rate (upstream) 48 kbps 46.666 kbps 45.333 kbps 44 kbps 42.666 kbps 41.333 kbps 40 kbps 38.666 kbps 37.333 kbps 36 kbps 34.666 kbps 33.333 kbps 32 kbps 30.666 kbps 29.333 kbps 28 kbps 26.666 kbps 25.333 kbps 24 kbps	ITU-T V.92 ITU-T V.92

Table 8. Protocol Characteristics (Continued)

Item	Specification
Data Rate 33.6 kbps 31.2 kbps 28.8 kbps 26.4 kbps 24.0 kbps 21.6 kbps 19.2 kbps 16.8 kbps 14.4 kbps 12.0 kbps 9600 bps 7200 bps 4800 bps 2400 bps 1200 bps 300 bps 300 bps	ITU-T V.34 ITU-T V.34 ITU-T V.34 ITU-T V.34 ITU-T V.34 ITU-T V.34 ITU-T V.34 ITU-T V.34 ITU-T V.34 ITU-T V.34 or V.32bis ITU-T V.34 or V.32bis ITU-T V.34 or V.32bis ITU-T V.34 or V.32bis ITU-T V.34 or V.32bis ITU-T V.34, IV.32 bis, or V.22bis ITU-T V.22bis, V.23, or Bell 212A ITU-T V.21 Bell 103
Data Format Bit asynchronous	Selectable 8, 9, 10, or 11 bits per character, which includes the start, stop, and parity bits.
Compatibility	ITU-T V.92, V.90, V.34, V.32bis, V.32, V.23, V.22bis, V.22, V.21, Bell 212A, and Bell 103
Operating Mode Switched network	Two-wire full duplex
Data Modulation 28 to 56 kbps (downstream) 24 to 48 kbps (upstream) 2.4 to 33.6 kbps 14.4 kbps 12.0 kbps 9600 kbps 9600 kbps 7200 kbps 4800 kbps 2400 kbps 1200 kbps 0 to 300 kbps	V.90 as specified by ITU-T V.92 as specified by ITU-T V.34 as specified by ITU-T 128-level TCM/2400 Baud $\pm 0.01\%$ 64-level TCM/2400 Baud $\pm 0.01\%$ 32-level TCM/2400 Baud $\pm 0.01\%$ 16-level QAM/2400 Baud $\pm 0.01\%$ 16-level TCM/2400 Baud $\pm 0.01\%$ 4-level QAM/2400 Baud $\pm 0.01\%$ 16-level QAM/600 Baud $\pm 0.01\%$ 4-level PSK/600 Baud $\pm 0.01\%$ FSK 0–300 Baud $\pm 0.01\%$
Answer Tone ITU-T V.32bis, V.32, V.22bis, V.22, and V.21 modes Bell 212A and 103 modes	2100 Hz ± 3 Hz 2225 Hz ± 3 Hz

Table 8. Protocol Characteristics (Continued)

Item	Specification
Transmit Carrier V.92 V.90 V.34 ITU-T V.32bis ITU-T V.32 ITU-T V.29 ITU-T V.22, V.22bis/Bell 212A Originate mode Answer mode ITU-T V.21 Originate mode Answer mode Bell 103 Originate mode Answer mode	As specified by ITU-T As specified by ITU-T As specified by ITU-T 1800 Hz \pm 0.01% 1800 Hz \pm 0.01% 1700 Hz \pm 1 Hz 1200 Hz \pm 0.5 Hz 2400 Hz \pm 1 Hz Mark (980 Hz \pm 12 Hz) Space (1180 Hz \pm 12 Hz) Mark (1650 Hz \pm 12 Hz) Space (1850 Hz \pm 12 Hz) Mark (1070 Hz \pm 12 Hz) Space (1270 Hz \pm 12 Hz) Mark (2025 Hz \pm 12 Hz) Space (2225 Hz \pm 12 Hz)
Output Level Permissive—Switched network	-9 dBm maximum
Receive Carrier ITU-T V.90 ITU-T V.34 ITU-T V.32bis ITU-T V.32 ITU-T V.29 ITU-T V.22, V.22bis/Bell 212A Originate mode Answer mode ITU-T V.21 Originate mode Answer mode Bell 103 Originate mode Answer mode	As specified by ITU-T As specified by ITU-T 1800 Hz \pm 7 Hz 1800 Hz \pm 7 Hz 1800 Hz \pm 7 Hz 2400 Hz \pm 7 Hz 1200 Hz \pm 7 Hz Mark (1650 Hz \pm 12 Hz) Space (1850 Hz \pm 12 Hz) Mark (1650 Hz \pm 12 Hz) Space (1850 Hz \pm 12 Hz) Mark (2025 Hz \pm 12 Hz) Space (2225 Hz \pm 12 Hz) Mark (1070 Hz \pm 12 Hz) Space (1270 Hz \pm 12 Hz)
Carrier Detect (level for ITU-T V.22bis, V.22, V.21, 212, 103) in Switched Network	Acquisition (-43 dBm) Release (-48 dBm)
Hysteresis	2 dBm minimum
ITU-T V.90, V.34, V.32/V.32bis are echo canceling protocols that use signal quality as criteria for maintaining connection. They also provide for self-training detection to force disconnect.	
DTE Interface	EIA/TIA-232-E (ITU-T V.24/V.28/ISO 2110)
Line Equalization	Automatic Adaptive
Connection Options	Loss of Carrier in ITU-T V.22bis and lower

Table 8. Protocol Characteristics (Continued)

Item	Specification
Phone Types	500 (rotary dial), 2500 (DTMF dial)
Dialing	Pulse and Tone
DTMF Output Level	Per Part 68
Pulse Dial Ratio	Make/Break: 39/61%
Ring Cadence	On 2 seconds; Off 4 seconds
Call Progress Monitor	BUSY CONNECT (rate) NO ANSWER NO CARRIER NO DIALTONE OK RING RINGING

4. Functional Description



Figure 6. Functional Block Diagram

The Si2494/39 ISModem[®] is a complete embedded modem chipset with integrated direct access arrangement (DAA) that provides a programmable line interface to meet global telephone line requirements. This solution includes a DSP data pump, modem controller, on-chip RAM and ROM, codec, DAA, analog output, and a PLL clocking generator.

The Si2494/39 accepts standard modem AT commands and provides connect rates up to 56/33.6/14.4/2.4 kbps full-duplex over the Public Switched Telephone Network (PSTN). The Si2494/39 features a complete set of modem protocols including all ITU-T standard formats up to V.92.

The Si2494/39 features a direct interface to the Si3000 voice codec. Itself a highly integrated device, the Si3000 provides a codec, mixer, digital gain control, microphone preamp, microphone bias generator, speaker driver, and line in/out ports for use with external amplifiers. The Si3000 codec combined with the features of the on-chip DSP supports a voice handset and/or full-duplex speakerphone including programmable levels, frequency response, limiting/soft-clipping and sidetone generation. Voice pass-through with optional compression supports implementation of a tapeless answering machine (TAM), music-on-hold, voice menus, etc.

The ISModem provides numerous additional features for embedded modem applications. The modem includes full type I and type II caller ID detection and decoding for global standards, DTMF tone generation and detection, Short Message Service (SMS), distinctive ring detection, and call progress monitoring via a PWM audio output. Call progress monitoring is supported through standard result codes. The modem is also programmable to meet global settings. Because the Si2494/39 ISModem integrates the DAA, analog features, such as parallel phone detect, overcurrent detection, and global PTT compliance with a single design, are included.

This device is ideal for embedded modem applications due to its small board space, low power consumption, and global compliance. The Si2494/39 solution includes a silicon DAA using Silicon Laboratories' proprietary third-generation DAA technology. This highly-integrated DAA can be programmed to meet worldwide PTT specifications for ac termination, dc termination, ringer impedence, and ringer threshold. In addition, the Si2494/39 has been designed to meet the most stringent worldwide requirements for out-of-band energy, billing-tone immunity, surge immunity, and safety requirements.

The Si2494/39 allows for rapid integration into existing modem applications by providing a serial interface that can directly communicate to either a microcontroller via a UART interface or a PC via an RS-232 port. This interface allows for PC evaluation of the modem immediately upon powerup via the AT commands using standard terminal software.

4.1. Host Interface

The Si2494/39 interfaces to the host processor through either an asynchronous serial interface, a synchronous Serial Peripheral Interface (SPI), or a parallel interface. The default is asynchronous serial communication. Selection of either SPI or parallel interface is done on power-up with reset strapping. Please refer to "AN93: ISOModem[®] Chipset Family Designer's Guide" for details.

4.1.1. Asynchronous Serial Interface

The Si2494/39 supports asynchronous serial communication with data terminal equipment (DTE) at rates up to 307.2 kbps with the standard serial UART format. Upon powerup, the UART baud rate is automatically detected using the autobaud feature.

4.1.2. Serial Peripheral Interface (SPI)

The serial peripheral interface (SPI) provides a flexible synchronous serial bus for host processor and Si2494/39 ISOModem communication. When the Si2494/39 is powered up with SPI mode enabled the modem becomes an SPI slave, and the pins are configured to SS (slave select input, active low), MOSI (serial data input to modem), MISO (serial data output from modem) and SCLK (serial data clock input). Each SPI operation consists of a control-and-address byte and a data byte.

4.1.3. Parallel Interface

The Si2494/39 can also communicate via a parallel interface. The parallel interface is an 8-bit data bus with a single bit address to memory mapped registers.

4.2. Command Mode

Upon reset, the ISModem[®] is in command mode and accepts “AT” commands. An outgoing modem call can be made using the “ATDT#” (tone dial) or “ATDP#” (pulse dial) command after the device is configured. If the handshake is successful, the modem responds with the response codes detailed in Table 14 on page 49 and enters data mode.

4.3. Data Mode

The Si2494/39 ISModem is in data mode while it has a telephone line connection to another modem or is in the process of establishing a connection.

Data protocols are available to provide error correction to improve reliability (V.42 and MNP2-4) and data compression to increase throughput (V.44, V.42bis and MNP5).

Each connection between two modems in data mode begins with a handshaking sequence. During this sequence, the modems determine the line speed, data protocol, and related parameters for the data link. Configuration through AT commands determines the range of choices available to the modem during the negotiation process.

4.4. Fast Connect

The Si2494/39 supports a fast connect mode of operation to reduce the time of a connect sequence in originate mode. The Fast Connect modes can be enabled for V.21, V.22, Bell103, and V.29 modulations. See AN93 for details.

4.5. V.80 Synchronous Access Mode

The Si2494/39 supports a V.80 synchronous access mode of operation, which operates with an asynchronous DTE and a synchronous DCE. See “AN93: ISModem[®] Chipset Family Designer's Guide”.

4.6. Voice Mode (+FCLASS=8)

The Si2494/39 supports the implementation of voice handset, tapeless answering machine (TAM), and speakerphone functions when used with the Si3000 voice codec. The Si3000 provides a direct interface to most handsets, including a variable gain microphone preamplifier, microphone bias for an electret (condenser) microphone, digital volume control, and a speaker driver. Additional Line In/Out ports can be used with external amplifiers to support other audio sources/destinations, such as a microphone and speaker for hands-free operation. Very few external components are required between the handset and the Si3000. See the Si3000 Voiceband Codec with Microphone/Speaker Drive data sheet and AN93 Modem Designer's Guide for more details. ITU-T V.253 commands are used to control operation in voice mode. Voice mode is enabled by the AT command +FCLASS=8. The Si2494 /39 DSP provides programmable soft transmit level limiters, programmable transmit and receive gains, sidetone gain, and programmable transmit and receive filters for frequency shaping. These features provide a completely programmable voice implementation capable of compliance with the international standards including TBR 38 and EIA/TIA-470.

Voice mode is typically the system's idle state. While in this state, the ISModem monitors the telephone line for various events, such as DTMF detection, caller ID, or ringing (including distinctive ring). Once an event is detected, the ISModem sends the host either a simple event code (a single character) or a complex event code (multiple characters) preceded by a <DLE> character to the host. For a full list of event reports, see Table 9 on page 22. In voice mode, the ISModem can generate DTMF and single tones using the +VTS command; the +VLS command is used to enable event reporting and tone generation and to control the on/off hook state. Table 9 on page 22 lists the events that are supported based on the +VLS state.

4.7. Clocking

The Si2494/39 contains an on-chip phase-locked loop (PLL) and clock generator to derive all necessary internal system clocks from a single clock input. A 32.768 kHz or 4.9152 MHz crystal can be used across XTALI and XTALO pins to form the master clock (± 100 ppm max, ± 25 ppm recommended) for the ISModem. The 32.768 kHz option can provide lower BOM costs and smaller footprint. Alternatively, a clock input of 27 MHz or 4.9152 MHz can be provided to XTALI if that clock source is available in the system. A 4.9152 MHz clock input is the default clock option. Other clock options are selected at power-up through reset strapping. Refer to AN93 for details.

4.8. Low-Power Modes

The Si2494/39 provides multiple low power modes. Using the S24 S-register, the Si2494/39 can be set to automatically enter sleep mode after a pre-programmed time of inactivity with either the DTE or the remote modem. The sleep mode is entered after (S24) seconds have passed since the last DTE activity, after the transmit FIFO is empty, and after the last data are received from the remote modem.

Additionally, the Si2494/39 can be placed in wake-on-ring-mode using the command, AT&Z. In either mode, the ISModem remains in the sleep state until one of the following occurs:

- A 1-to-0 transition on TXD (UART mode).
- A 1-to-0 transition on SS (SPI mode).
- A 1-to-0 transition on CS (parallel mode).
- An incoming ring is detected.
- A parallel telephone is picked up.
- Line polarity reversal

The Si2494/39 may also be placed in a complete powerdown mode. Once the Si2494/39 completely powers down, it can only be powered back on via the RESET pin.

4.9. Data Compression

The modem can achieve DTE (host-to-ISModem) speeds greater than the maximum DCE (modem-to-modem) speed through the use of a data compression protocol. The compression protocols available are the ITU-T V.44, V.42bis, and MNP5 protocols. Data compression attempts to increase throughput by compressing the data before actually sending it. Thus, the modem is able to transmit more data in a given period of time.

4.10. Error Correction

The Si2494/39 ISModem can employ error correction (reliable) protocols to ensure error-free delivery of asynchronous data sent between the host and the remote end. The Si2494/39 supports V.42 and MNP2-4 error correction protocols. V.42 (LAPM) is most commonly used and is enabled by default.

4.11. Wire Mode

Wire mode is used to communicate with standard non-error correcting modems. When optioned with \N3, the Si2494/39 falls back to wire mode if it fails in an attempt to negotiate a V.42 link with the remote modem. Error correction and data compression are not active in wire mode.

Table 9. V.253 Event Reporting in Voice Mode

Event Description	Reporting	+VLS
Caller Id Report	Complex	0,4,20,21
Distinctive Ringing	Complex	0,4,20,21
RING	R	0,4,20,21
DTMF Received	1-9,A-D,*,#	1,5,20,21
Facsimile Calling (e.g. 1100 Hz)	c	1,5,20,21
Data Calling (e.g. 1300 Hz)	e	1,5,20,21
Presumed End of Message (QUIET) Time-out	q	1,5,20,21
Loop Current Interruption	l	1,5,20,21
Ringing Tone	r	1,5,20,21
BUSY	b	1,5,20,21
DIALTONE	d	1,5,20,21
Extension Phone On-hook	p	0,1,4,5,20,21
Extension Phone Off-hook	P	0,1,4,5,20,21
Facsimile or Data Answer (e.g. 2100 Hz)	a	1,5,20,21
Data Answer (e.g. 2225 Hz)	f	1,5,20,21

4.12. V.92 PCM Upstream

The Si2494/39 supports the ITU-V.92 PCM upstream data protocol. This protocol allows the ISModem to connect at speed up to 48 kbps upstream. Previously the upstream connection rate was limited to 33.6 kbps. The PCM upstream mode is enabled by default; to disable, issue the AT command +PIG = 1 (see Table 10 on page 27). To view both downstream and upstream connect speeds in the connect result message, issue the command "AT \V4" or "AT+MR".

4.13. V.92 Quick Connect

The Si2494/39 supports the ITU-V.92 quick connect protocol. Quick connect enables the modem to save and reuse line condition parameters to reduce startup negotiation time.

The quick connect feature is enabled by default in the Si2494/39. For information on changing the quick connect settings, see the +PSS and +PQC commands shown in Table 10 on page 27.

4.14. V.92 Modem-on-Hold

The modem-on-hold (MOH) feature allows the modem user to answer an incoming call while connected online without dropping the internet connection. The modem will remain "on hold" for a period of time determined by the host and the ISP. There are four AT commands that control the operation of MOH. The commands are as follows: +PCW, +PMH, +PMHT, +PMHR. By changing these parameters, the user can enable/disable call waiting and MOH, set the MOH request timeout, and set the MOH initiate timeout. For further details and syntax on these commands see Table 10 on page 27. The MOH feature is most useful when the Si2494/39 is connected to a central office that allows call waiting.

4.15. Caller ID Operation

The Si2494/39 supports full type I and type II caller ID detection and decode. Caller ID is supported for the US Bellcore, European ETSI, UK, and Japanese protocols and is enabled via the +VCID, +VCDT, and +PCW commands.

4.16. Parallel Phone Detection

The ISModem[®] is able to detect when another telephone, modem, or other device is using the phone line. This allows the host to avoid interrupting another phone call when the phone line is already in use and to intelligently handle an interruption when the ISModem is using the phone line.

4.16.1. On-Hook Line-in-use Detection

When the ISModem is sharing the telephone line with other devices, it is important that it not interrupt a call in progress. To detect whether another device is using the shared telephone line, the host can use the ISModem to monitor the TIP-RING dc voltage with the line voltage sense (LVS) register (U6C, bits 15:8). The LVS bits have a resolution of 1 V per bit with an accuracy of approximately $\pm 10\%$. Bits 0 through 6 of this 8-bit signed two's complement number indicate the value of the line voltage, and the sign bit (bit 7) indicates the polarity of TIP and RING. The ISModem can also monitor the TIP-RING dc voltage using the LVCS register (U79, bits 4:0). See Figure 7 on page 23. See also the %Vn commands for automatic line-in-use detection.

4.16.2. Off-Hook Intrusion Detection

When the ISModem is off-hook, an algorithm is implemented in the ISModem to automatically monitor the TIP-RING loop current via the LVCS register. During the off-hook state, the LVCS register switches from representing the TIP-RING voltage to representing the TIP-RING current. See Figure 8 on page 24. Upon detecting an intrusion, the ISModem alerts the host of the condition via the INT pin.



Figure 7. Loop Voltage

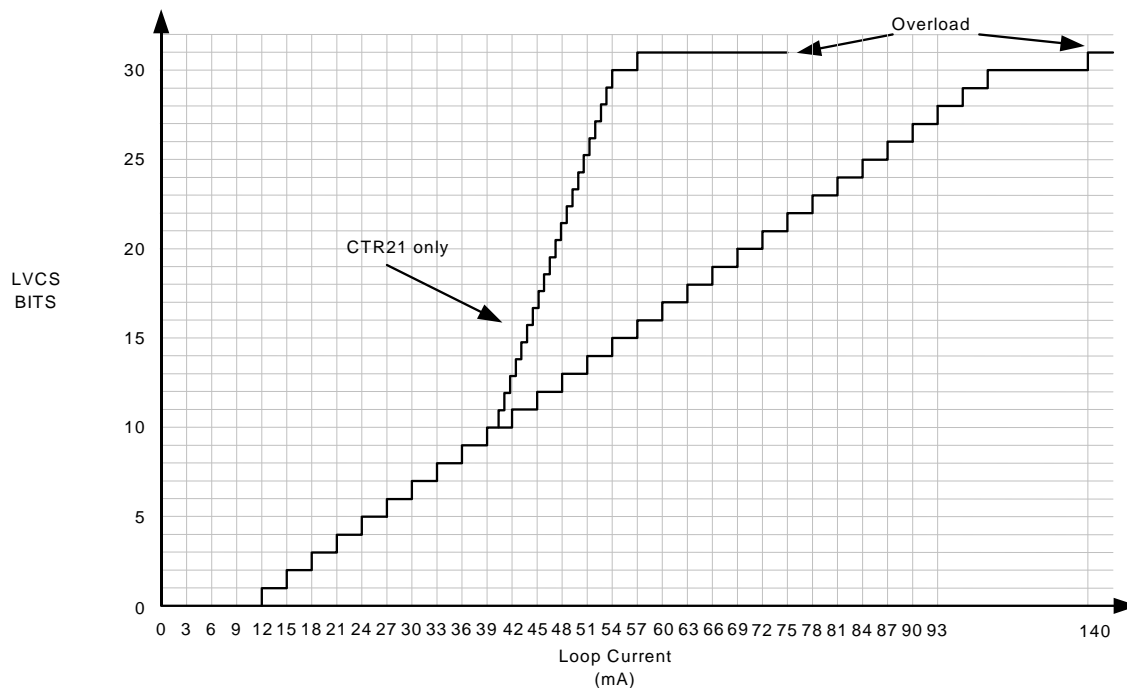

Figure 8. Loop Current

4.17. Overcurrent Detection

The Si2494/39 includes an overcurrent detection feature that measures the loop current at a programmable time after the Si2494/39 goes off-hook. This allows the Si2494/39 to detect if it is connected to an improper telephone line. The overcurrent detection feature may be enabled by setting the OCDM bit (U70, bit 11). OHT (U77, bits 8:0) sets the delay after off-hook until the loop current is measured. See “AN93: ISModem[®] Chipset Family Designer’s Guide” for details.

4.18. Global Operation

The Si2494/39 chipset contains an integrated silicon direct access arrangement (Silicon DAA) that provides a programmable line interface to meet international telephone line interface requirements. “AN93: Modem Designer’s Guide” gives the DAA register settings required to meet international PTT standards.

Additionally, the user-access registers (via the AT:U and AT:R commands) may be programmed for country-specific settings, such as dial tone, ring, ringback, and busy tone. See AN93 for complete details.

4.19. Firmware Upgrades

The Si2494/39 contains an on-chip program ROM that includes the firmware required for the features listed in this data sheet. In addition, the Si2494/39 contains on-chip program RAM to accommodate minor changes to the ROM firmware. This allows Silicon Labs to provide future firmware updates to optimize the characteristics of new modem designs and those already deployed in the field. See AN93 for complete details.

4.20. DTMF Detection / Generation

The Si2494/39 provides comprehensive DTMF tone generation and detection. The ISModem can generate single tones or DTMF tones using the +VTS command. DTMF tones may also be generated during dialing using the “ATDT” command. DTMF detection is only available in voice mode (FCLASS = 8). DTMF digits are reported from the modem to the host using <DLE> shielding.

4.21. SMS/MMS Support

Short Message Service (SMS) is a service that allows text messages to be sent and received from one telephone to another via an SMS service center. Multimedia Messaging Service (MMS) extends the core SMS capability to send messages that include multimedia content. The Fax ISModem provides an interface that offers a great deal of flexibility in handling multiple SMS standards. This flexibility is possible because most of the differences between standards are handled by the host using the raw data itself. The Si2494/39 performs the necessary modulation/demodulation of the data and provides two options for message packet structure (Protocol 1 and Protocol 2, as defined in ETSI ES 201 912). The rest of the data link layer and transfer layer are defined by the host system.

The content of the message is entirely up to the host including any checksum or CRC. ETSI ES 201 912 describes two standard data and transfer layers that are commonly used. SMS typically relies on caller identification information to determine if the call should be answered using an SMS device or not.

See “6.4. SMS Support” in AN93 for more information on how to configure the modem for SMS support.

4.22. Codec Interface

In order to support a full range of voice and data applications, the Si2494/39 includes an optional serial interface that connects to an external voice codec (Si3000). See AN93 for complete details.

4.23. Answering Machine Support

The TAM voice compression support includes the following formats:

- Signed linear 8-bit, 64 kbps
- Unsigned linear 8-bit, 64 kbps
- G.711 μ -law 8-bit, 64 kbps
- G.711 A-law 8-bit, 64 kbps
- G.726 ADPCM 2-bit, 16 kbps
- G.726 ADPCM 4-bit, 32 kbps

All formats use a fixed 8 kHz sampling rate. For most applications, the user wants a high-quality message format (64 kbps) for the Outgoing Message (OGM) and is less concerned about the Incoming Message (ICM) quality. Higher compression results in less memory use. Less compression results in higher speech quality. See AN 93 for details. This section covers the functional operation of handset, TAM, and speakerphone modes and includes use cases with the programming examples.

4.24. Voice Pass-Through (Speakerphone)

Voice pass-through operation employs an acoustical echo canceller (AEC), acoustical echo suppressor (AES), double-talk detector (DTD), and line echo canceller (LEC). They provide the following performance:

- Programmable echo tail filter length: up to 64 ms
- Convergence speed (white noise): < 1.6 s
- Single-talk echo suppression: > 48 dB
- Double-talk echo suppression: > 30 dB

See Appendix of AN93 for details. This section covers the functional operation of handset, TAM, and speakerphone modes and includes use cases with programming examples.

4.25. General-Purpose Tone Detectors

Two general-purpose tone detectors based on 4th-order I-quad filters are provided in addition to the other dedicated tone detectors described in this document. These tone detectors are referred to as the Tone A detector and the Tone B detector. They can operate independently or Tone B can receive the output of Tone A to implement a higher-order tone detector. All filter coefficients and detector functions are controlled through U-Registers.

These tone detectors are available for use in any operational mode. Whenever an enabled tone detector output transitions, a message will be generated. The messages follow the DLE shielded format for complex reporting. Refer to AN93 for more details.

4.26. EEPROM Interface

The Si2494/39 supports an optional serial peripheral interface (SPI) bus serial EEPROM Mode 3 with a 16-bit (8–64 kbit range) address. The EEPROM is intended first for setting custom defaults, second for automatically loading firmware upgrades, and third to allow for user-defined AT command macros for use in custom AT commands or country codes. See AN93 for complete details.

4.27. AT Commands

At powerup, the Si2494/39 is in the AT command mode. In command mode, the modem monitors the input (serial or parallel) checking constantly for a valid command (AT commands are described in Table 10.)

Table 10. Basic AT Command Set (Command Defaults in Bold)

Command	Action	
\$	Display AT command mode settings.	
A	Answer incoming call	
A/	Re-execute last command. This is the only command not preceded by "AT" or followed by a <CR>.	
Dn	Dial The dial command, followed by 1 or more dial command modifiers, manually dials a phone number:	
	Modifier	Function
	! or &	Flash hook switch for FHT (U4F) ms (default: 500 ms)
	, or <	Pause before continuing for S8 seconds (default: 2 seconds)
	;	Return to AT command mode
	@	Wait for silence.
	G	Polarity reversal detect. By placing the "G" character in the dial string (i.e. ATDTG1), the Si2494/39 will monitor the telephone line for polarity reversals. If a busy tone is detected, the Si2494/39 will report "POLARITY REVERSAL" if a polarity reversal was detected or "NO POLARITY REVERSAL" if a polarity reversal was not detected. In each case, the result code is followed by "OK". If the S7 timeout occurs before a busy tone is detected, the Si2494/39 will report "NO CARRIER". Polarity reversal monitoring begins after the last digit is dialed and ends when the busy tone is detected or S7 timeout occurs. Note: It is not possible to establish a modem connection when using this command.
	L	Redial last number.
	P	Pulse (rotary) dialing—pulse digits: 0, 1, 2, 3, 4, 5, 6, 7, 8, 9
	T	Tone (DTMF) dialing—DTMF digits: *, #, A, B, C, D, 0, 1, 2, 3, 4, 5, 6, 7, 8, 9.
W	Wait for dial tone before continuing for S14 seconds (default: 12 seconds). Blind dialing modes X0, X1 and X3 do not affect the W command.	
	If the DOP bit (U7A, bit 7) is set, the "ATDTW" command will cause the ISOModem® to pause dialing and either report an "OK" if a dialtone is detected or "NO DIALTONE" if a dial tone is not detected.	
En	Local DTE echo	
E0	Disable	
E1	Enable	
Hn	Hook switch.	

Table 10. Basic AT Command Set (Command Defaults in Bold) (Continued)

Command	Action
H0	Go on-hook (hang up modem).
H1	Go off-hook.
In	Identification and checksum.
I0	Display Si2494/39 revision code. A: Revision A
I1	Display Si2494/39 firmware revision code (numeric).
I3	Display line-side revision code. 18F=Si3018 revision F
I6	Display the ISModem [®] model number. "2494" = Si2494 "2439" = Si2439
I7	Diagnostic results 1. See "AN93: ISOModem [®] Chipset Family Designer's Guide" for details.
I8	Diagnostic results 2. See AN93 for details.
Ln	Speaker volume operation
L1	Low speaker volume
L2	Medium speaker volume
L3	High speaker volume
L4	Very high speaker volume
Mn	Speaker operation (via AOUT).
M0	Speaker is always off.
M1	Speaker is on while dialing and handshaking; off in data mode.
M2	Speaker is always on.
M3	Speaker is off while dialing, on during handshaking and retraining.
On	Return to data mode from Command mode operation.
O0	Return to data mode.
O1	Return to data mode and perform a full retrain (at any speed except 300 bps).
O2	Return to data mode and perform rate renegotiation.
Qn	Response mode.
Q0	Enable result codes (see Table 14 on page 49)
Q1	Disable result codes (enable quiet mode).
R	Initiate V.23 reversal.
Sn	S-register operation (see Table 15 on page 51).
S\$	List contents of all S registers.
Sn?	Display contents of S-register n.
Sn=x	Set S-register n to value x (where n and x are decimal values).

Table 10. Basic AT Command Set (Command Defaults in Bold) (Continued)

Command	Action
Vn	Result code type (see Table 14 on page 49).
V0	Numeric result codes.
V1	Verbal result codes
Xn	Call Progress Monitor (CPM)—This command controls which CPM signals are monitored and reported to the host from the Si2494/39. (See Table 14 on page 49.)
X0	Basic results; disable CPM—Blind dial (does not wait for dial tone). CONNECT message does not include speed.
X1	Extended results; disable CPM—Blind dial. CONNECT message includes speed.
X2	Extended results and detect dial tone only—Add dial tone detection to X1 mode. Does not blind dial.
X3	Extended results and detect busy only—Add busy tone detection to X1 mode.
X4	Extended results, full CPM—Full CPM enabled, CONNECT message includes speed.
X5	Extended results—Full CPM enabled including ringback detection. Adds ringback detection to X4 mode.
Yn	Long space disconnect—Modem hangs up after 1.5 seconds or more of continuous space while on-line.
Y0	Disable.
Y1	Enable.
Z	Hard Reset—This command is functionally equivalent to pulsing the RESET pin low. (See t _{AT} in Table 5 on page 8.)
:E	Read from serial EEPROM.
:I	Interrupt Read—This command causes the ISOModem [®] to report the lower 8 bits of the interrupt register I/O Control 0 (U70). The CID, OCD, PPD, and RI bits also are cleared, and the INT pin (INT bit in parallel mode) is deactivated on this read.
:M	Write to serial EEPROM.
:P	Program RAM Write—This command is used to upload firmware supplied by Silicon Labs to the Si2494/39. The format for this command is AT:Paaaa,xxxx,yyyy,... where aaaa is the first address in hexadecimal and xxxx,yyyy,... is data in hexadecimal. Only one :P command is allowed per AT command line. No other commands can be concatenated in the :P command line. This command is <i>only</i> for use with special files provided by Silicon Laboratories. Do not attempt to use this command for any other purpose.
:R	User-Access Register Read—This command allows the user to read from the user-access registers (see "6. User-Access Registers (U-Registers)" on page 54). The format is "AT:Raa", where: aa = user-access address in hexadecimal. The "AT:R" command causes all the U- registers to be displayed.
:U	User-Access Register Write—This command allows the user to write to the 16-bit user-access registers. (See page page 54.) The format is "AT:Uaa,xxxx,yyyy,zzzz,..." where aa = user-access address in hexadecimal. xxxx = Data in hexadecimal to be written to location aa. yyyy = Data in hexadecimal to be written to location (aa + 1). zzzz = Data in hexadecimal to be written to location (aa + 2). etc.

Table 10. Basic AT Command Set (Command Defaults in Bold) (Continued)

Command	Action																								
*Y[sequence]	<p>Special Access Mode—This command enables special modes and data memory access.</p> <table> <thead> <tr> <th>[sequence]</th> <th>Description</th> </tr> </thead> <tbody> <tr> <td>254:Waaaa,dddd</td> <td>Write hexadecimal data value dddd to hexadecimal data address aaaa. Only one 254:W command per line.</td> </tr> <tr> <td>254:Qaaaa</td> <td>Read hexadecimal address aaaa. Returns hexadecimal data value dddd. Only one 254:Q command per line.</td> </tr> <tr> <td>2</td> <td>Enable continuous answer tone for the ATA command. Use ATZ to clear this mode. For example, the single-line, multiple command is AT*Y2A.</td> </tr> <tr> <td>1</td> <td>Enable continuous DTMF tone for first digit used in the ATD command. Use ATZ to clear this mode. For example, the single-line, multiple command for a continuous DTMF “1” digit would be AT*Y1D1.</td> </tr> <tr> <td>0</td> <td>Exit from 254:W or 254:Q access mode. Must reside on a separate line and must be the final sequence be sent after the final 254:W or 254:Q command.</td> </tr> </tbody> </table>	[sequence]	Description	254:Waaaa,dddd	Write hexadecimal data value dddd to hexadecimal data address aaaa. Only one 254:W command per line.	254:Qaaaa	Read hexadecimal address aaaa. Returns hexadecimal data value dddd. Only one 254:Q command per line.	2	Enable continuous answer tone for the ATA command. Use ATZ to clear this mode. For example, the single-line, multiple command is AT*Y2A.	1	Enable continuous DTMF tone for first digit used in the ATD command. Use ATZ to clear this mode. For example, the single-line, multiple command for a continuous DTMF “1” digit would be AT*Y1D1.	0	Exit from 254:W or 254:Q access mode. Must reside on a separate line and must be the final sequence be sent after the final 254:W or 254:Q command.												
[sequence]	Description																								
254:Waaaa,dddd	Write hexadecimal data value dddd to hexadecimal data address aaaa. Only one 254:W command per line.																								
254:Qaaaa	Read hexadecimal address aaaa. Returns hexadecimal data value dddd. Only one 254:Q command per line.																								
2	Enable continuous answer tone for the ATA command. Use ATZ to clear this mode. For example, the single-line, multiple command is AT*Y2A.																								
1	Enable continuous DTMF tone for first digit used in the ATD command. Use ATZ to clear this mode. For example, the single-line, multiple command for a continuous DTMF “1” digit would be AT*Y1D1.																								
0	Exit from 254:W or 254:Q access mode. Must reside on a separate line and must be the final sequence be sent after the final 254:W or 254:Q command.																								
+DR=X	<p>Data compression reporting.</p> <table> <thead> <tr> <th>X</th> <th>Mode</th> </tr> </thead> <tbody> <tr> <td>0</td> <td>Disabled</td> </tr> <tr> <td>1</td> <td>Enabled</td> </tr> </tbody> </table> <p>If enabled, the intermediate result code is transmitted at the point after error control negotiation. The format of this result code is as follows:</p> <table> <thead> <tr> <th>Result code</th> <th>Mode</th> </tr> </thead> <tbody> <tr> <td>+DR:NONE</td> <td>Data compression is not in use</td> </tr> <tr> <td>+DR:V42B</td> <td>Rec. V.42bis is in use in both directions</td> </tr> <tr> <td>+DR:V42B RD</td> <td>Rec. V.42bis is in use in receive direction only</td> </tr> <tr> <td>+DR:V42B TD</td> <td>Rec. V.42bis is in use in transmit directions only</td> </tr> </tbody> </table>	X	Mode	0	Disabled	1	Enabled	Result code	Mode	+DR:NONE	Data compression is not in use	+DR:V42B	Rec. V.42bis is in use in both directions	+DR:V42B RD	Rec. V.42bis is in use in receive direction only	+DR:V42B TD	Rec. V.42bis is in use in transmit directions only								
X	Mode																								
0	Disabled																								
1	Enabled																								
Result code	Mode																								
+DR:NONE	Data compression is not in use																								
+DR:V42B	Rec. V.42bis is in use in both directions																								
+DR:V42B RD	Rec. V.42bis is in use in receive direction only																								
+DR:V42B TD	Rec. V.42bis is in use in transmit directions only																								
+DS Options +DS = A +DS = A,B +DS = A,B,C +DS = A,B,C,D	<p>Controls V.42bis data compression function.</p> <table> <thead> <tr> <th>A</th> <th>Direction</th> </tr> </thead> <tbody> <tr> <td>0</td> <td>No compression</td> </tr> <tr> <td>1</td> <td>Transmit only</td> </tr> <tr> <td>2</td> <td>Receive only</td> </tr> <tr> <td>3</td> <td>Both Directions</td> </tr> </tbody> </table> <table> <thead> <tr> <th>B</th> <th>Compression_negotiation</th> </tr> </thead> <tbody> <tr> <td>0</td> <td>Do not disconnect if V.42 is not negotiated.</td> </tr> <tr> <td>1</td> <td>Disconnect is V.42 is not negotiated.</td> </tr> </tbody> </table> <table> <thead> <tr> <th>C</th> <th>Maximum dictionary size</th> </tr> </thead> <tbody> <tr> <td>512</td> <td></td> </tr> </tbody> </table> <table> <thead> <tr> <th>D</th> <th>Maximum string size</th> </tr> </thead> <tbody> <tr> <td>6 to 250</td> <td>(28 default)</td> </tr> </tbody> </table>	A	Direction	0	No compression	1	Transmit only	2	Receive only	3	Both Directions	B	Compression_negotiation	0	Do not disconnect if V.42 is not negotiated.	1	Disconnect is V.42 is not negotiated.	C	Maximum dictionary size	512		D	Maximum string size	6 to 250	(28 default)
A	Direction																								
0	No compression																								
1	Transmit only																								
2	Receive only																								
3	Both Directions																								
B	Compression_negotiation																								
0	Do not disconnect if V.42 is not negotiated.																								
1	Disconnect is V.42 is not negotiated.																								
C	Maximum dictionary size																								
512																									
D	Maximum string size																								
6 to 250	(28 default)																								

Table 10. Basic AT Command Set (Command Defaults in Bold) (Continued)

Command	Action
+DS44 Options +DS44 = A +DS44 = A,B +DS44 = A,B,C	Controls V.44 data compression function. A Direction 0 No compression 1 Transmit only 2 Receive only 3 Both Directions B Compression_negotiation 0 Do not disconnect if V.44 is not negotiated. 1 Disconnect if Rec. V.42 is not negotiated. C Capability 0 Stream method
+ES Options +ES = A +ES = A,,C	Enable synchronous access mode. A Specifies the mode of operation when initiating a modem connection. D Disable synchronous assess mode. 6 Enable synchronous access mode when connection is completed and data state is entered. B Specifies fallback mode of operation. This parameter should not be used. C Specifies the mode of operation when answer a modem connection. D Disable synchronous assess mode. 8 Enable synchronous access mode when connection is completed and data state is entered.
+ESA Options +ESA = A +ESA = A,B +ESA = A,B,C +ESA = A,B,C,E +ESA = A,B,C,E,F +ESA = A,B,C,E,F, ,G	Synchronous access mode control options A Specifies action taken if an underrun condition occurs during transparent sub-mode. 0 Modem transmits 8-bit SYN sequences on idle. B Specifies action taken if an underrun condition occurs after a flag during framed sub-mode 0 Modem transmits 8-bit HDLC flags on idle. C Specifies action taken if an underrun or overrun condition occurs after a non-flag during framed sub-mode. 0 Modem transmits abort on underrun in middle of frame. 1 Modem transmits flag on underrun in middle of frame and notifies host of underrun or overrun. D Specifies V.34 half duplex operation. This parameter should not be used. E Specifies CRC polynomial used while in framed sub-mode. 0 CRC generation checking disable. 1 16-bit CRC generation and checking is performed by the modem. F Specifies NRZI encoding and decoding. 0 NRZI encoding and decoding disabled. G Specifies SYN. 255
+FCLASS = X	Class 1 Mode Enable for V.29 fast connect. <u>X</u> <u>Mode</u> 0 Data (limited to configuration only, data calls prohibited) 1 Enables support for Class 1 mode for use in the V.29 fast connect mode. 8 Voice mode

Table 10. Basic AT Command Set (Command Defaults in Bold) (Continued)

Command	Action
+FRM = X	Class 1 Receive Carrier for V.29 fast connect. <u>X</u> <u>Mode</u> 2 Transmit V.21 (980 Hz) tone for longer than 100 ms, then send answer tone (2100/2225 Hz) for 200 ms. 95 V.29 short synchronous. 96 V.29 full synchronous.
+FTM = X	Class 1 Transmit Carrier for V.29 fast connect. <u>X</u> <u>Mode</u> 2 Transmit V.21 (980 Hz) tone. 53 Same as &T4, but transmit V.29 7200 bps. Data pattern set by S40 register. AT + FCLASS = 0 must be sent to restore the ISModem [®] to normal operation after test. 54 Same as &T4, but transmit V.29 9600 bps. Data pattern set by S40 register. AT + FCLASS = 0 must be sent to restore the ISModem to normal operation after test. 95 V.29 short synchronous. 96 V.29 full synchronous.

Table 10. Basic AT Command Set (Command Defaults in Bold) (Continued)

Command	Action
	Country settings - Automatically configure all registers for a particular country.
<u>X</u>	<u>Country</u>
0	Japan
9	Australia
A	Austria
F	Belgium
16	Brazil
1B	Bulgaria
20	Canada
26	China
27	Columbia
2E	Czech Republic
31	Denmark
35	Ecuador
3C	Finland
3D	France
42	Germany
46	Greece
50	Hong Kong
51	Hungary
53	India
57	Ireland
58	Israel
59	Italy
61	South Korea
69	Luxembourg
6C	Malaysia
73	Mexico
7B	Netherlands
7E	New Zealand
82	Norway
87	Paraguay
89	Philippines
8A	Poland
8B	Portugal
9C	Singapore
9F	South Africa
A0	Spain
A5	Sweden
A6	Switzerland
B8	Russia
B4	United Kingdom
B5	United States
FE	Taiwan
+GCI = X	Note: U-registers are configured to Silicon Laboratories' recommended values. The +GCI command resets the U-registers and the S7 and S6 S-registers to default values before setting country-specific values. Changes may be made by writing individual registers after sending the AT+GCI command. Refer to "AN93: ISOModem [®] Chipset Family Designer's Guide" for details.
+GCI?	List current country code setting (response is: + GCI:<setting>)
+GCI = ?	List all possible country code settings.

Table 10. Basic AT Command Set (Command Defaults in Bold) (Continued)

Command	Action
+IFC Options +IFC = A +IFC = A,B	Specifies the flow control to be implemented. A Specifies the flow control method used by the host to control data from the modem 0 None 1 Local XON/OFF flow control. Does not pass XON/XOFF character to the remote modem. 2 Hardware flow control (RTS) B Specifies the flow control method used by the modem to control data from the host 0 None 1 Local XON/OFF flow control. 2 Hardware flow control (CTS).
+ITF Options +ITF = A +ITF = A,B +ITF = A,B,C	Transmit flow control threshold. A Threshold above which the modem will generate a flow off signal <0 to 511> bytes B Threshold below which the modem will generate a flow on signal <0 to 511> bytes C Polling interval for <BNUM> indicator 0 to 300 in 10 msec units.
+IPR = <rate>	Fixed DTE Rate. <u><rate></u> <u>Description</u> 0 Automatically detect the baud rate. [BPS] The decimal value of the rate in bits per second. Note that the <rate> parameter represents the DTE rate in bps and may be set to any of the following values: 300, 600, 1200, 2400, 4800, 7200, 9600, 12000, 14400, 19200, 38400, 57600, 115200, 230400, 245760, and 307200.
+MR = X	Modulation reporting control. <u>X</u> <u>Mode</u> 0 Disabled 1 Enabled If enabled, the intermediate result code is transmitted at the point during connect negotiation. The format of this result code is as follows: +MCR: <carrier> e.g. +MCR: V32B +MRR: <rate> e.g. +MRR: 14400

Table 10. Basic AT Command Set (Command Defaults in Bold) (Continued)

Command	Action
+MS Options +MS = A +MS = A,B +MS = A,B,C +MS = A,B,C,D +MS = A,B,C,D,E +MS = A,B,C,D,E, F	Modulation Selection. A Preferred modem carrier V21 ITU-T V.21 V22 ITU-T V.22 V22B ITU-T V.22bis V32 ITU-T V.32 V32B ITU-T V.32bis V34 ITU-T V.34 V90 ITU-T V.90 V92 ITU-T V.92 B Automatic modulation negotiation 0 Disabled 1 Enabled C,D Min TX rate/Max TX rate are optional numeric values that specify the lowest value at which the DCE may establish a connection. If unspecified (set to 0), they are determined by the carrier and automode settings. E,F Min RX rate/Max RX rate are optional numeric values which specify the highest value at which the DCE may establish a connection. If unspecified (set to 0), they are determined by the carrier and automode settings.
+PCW = X	Controls the action to be taken upon detection of call waiting. <u>X</u> <u>Mode</u> 0 Toggle \overline{RT} and collect type II Caller ID if enabled by +VCID. 1 Hang up. 2 Ignore call waiting.
+PIG=X	Controls the use of PCM upstream in a V.92 DCE. <u>X</u> <u>Mode</u> 0 Enable PCM upstream. 1 Disable PCM upstream.
+PMH=X	Controls the modem-on-hold procedures. <u>X</u> <u>Mode</u> 0 Enables V.92 MOH. 1 Disables V.92 MOH.
+PMHF=X	V.92 MOH hook flash. This command causes the DCE to go on-hook and then return off-hook. If this command is initiated and the modem is not On Hold, Error is returned.

Table 10. Basic AT Command Set (Command Defaults in Bold) (Continued)

Command	Action
+PMHR=X	<p>Initiate MOH. Requests the DCE to initiate or to confirm a MOH procedure. Valid only if MOH is enabled.</p> <p><u>X</u> <u>Mode</u></p> <p>0 V.92 MOH request denied or not available.</p> <p>1 MOH with 10 s timeout granted.</p> <p>2 MOH with 20 s timeout granted.</p> <p>3 MOH with 30 s timeout granted.</p> <p>4 MOH with 40 s timeout granted.</p> <p>5 MOH with 1 min. timeout granted.</p> <p>6 MOH with 2 min. timeout granted.</p> <p>7 MOH with 3 min. timeout granted.</p> <p>8 MOH with 4 min. timeout granted.</p> <p>9 MOH with 6 min. timeout granted.</p> <p>10 MOH with 8 min. timeout granted.</p> <p>11 MOH with 12 min. timeout granted.</p> <p>12 MOH with 16 min. timeout granted.</p> <p>13 MOH with indefinite timeout granted.</p> <p>14 MOH request denied. Future request will also be denied.</p>
+PMHT=X	<p>Controls access to MOH request and sets the timeout value.</p> <p><u>X</u> <u>Mode</u></p> <p>0 Deny V.92 MOH request.</p> <p>1 Grant MOH with 10 s timeout.</p> <p>2 Grant MOH with 20 s timeout.</p> <p>3 Grant MOH with 30 s timeout.</p> <p>4 Grant MOH with 40 s timeout.</p> <p>5 Grant MOH with 1 min. timeout.</p> <p>6 Grant MOH with 2 min. timeout.</p> <p>7 Grant MOH with 3 min. timeout.</p> <p>8 Grant MOH with 4 min. timeout.</p> <p>9 Grant MOH with 6 min. timeout.</p> <p>10 Grant MOH with 8 min. timeout.</p> <p>11 Grant MOH with 12 min. timeout.</p> <p>12 Grant MOH with 16 min. timeout.</p> <p>13 Grant MOH with indefinite timeout.</p>
+PQC=X	<p>V.92 Phase 1 and Phase 2 Control.</p> <p><u>X</u> <u>Mode</u></p> <p>0 Enable Short Phase 1 and Short Phase 2.</p> <p>1 Enable Short Phase 1.</p> <p>2 Enable Short Phase 2.</p> <p>3 Disable Short Phase 1 and Short Phase 2.</p>
+PSS=X	<p>Selection of full or short startup procedures.</p> <p><u>X</u> <u>Mode</u></p> <p>0 The DCEs decide to use short startup procedures.</p> <p>1 Forces the use of short startup procedures on next and subsequent connections.</p> <p>2 Forces the use of full startup procedures on next and subsequent connections.</p>

Table 10. Basic AT Command Set (Command Defaults in Bold) (Continued)

Command	Action
+VCDT = X	Caller ID Type. <u>X</u> <u>Mode</u> 0 After ring only 1 Always on (Recommended Setting) 2 UK 3 Japan
+VCID = X	Caller ID Enable. <u>X</u> <u>Mode</u> 0 Off 1 On—formatted 2 On—raw data format
+VCIDR?	Type II caller ID information — The Si2494/39 will display “+VCDIR:” followed by raw caller ID information including checksum.
+VDR = n	Distinctive Ring. <u>n</u> <u>Mode</u> 0,x Disable distinctive ring 1,0 Enable distinctive ring. The ISModem will report DROF and DRON result codes only. DROF and DRON are reported in 100 ms units. 1,x Enable distinctive ring. The ISModem will report DROF and DRON result codes as well as well as a RING result code x/10 seconds after the falling edge of a ring pulse. DROF and DRON are reported in 100 ms units.
+VGR	Receive Gain Selection. The <gain> parameter has a range of 112-134 with 128 being the nominal value. This represents a range of -48 dB to 18 dB. The default is 128 (0 dB). This command is used to control the receive gain at the DTE from either the Si3000 Codec or the DAA. The purpose is to adjust the DTE receive gain for the TAM voice stream during idle state.
+VGT	Transmit Gain Selection. The <gain> parameter has a range of 112-134 with 128 being the nominal value. This represents a range of -48 to 18 dB. The default is 128 (0 dB). This command is used to control the transmit gain at the DTE to either the Si3000 Codec or the DAA. The purpose is to adjust the DTE transmit gain for the TAM voice stream during idle state.
+VIP	Load Voice Factory Defaults.
+VIT	DTE/DCE Inactivity Timer. The <timer> parameter has a range of 0–255 with units of seconds. The default is 0 (disable).

Table 10. Basic AT Command Set (Command Defaults in Bold) (Continued)

Command	Action
+VLS = n	<p>Analog Source / Destination Select.</p> <p>n Description</p> <p>0 ISModem on-hook. AOUT disabled. Tone detectors disabled. Si3000 sample pass-through to DAA is inactive.</p> <p>1 ISModem off-hook. AOUT disabled. Tone detectors disabled.</p> <p>4 ISModem on-hook. AOUT connected to ISModem tone generators. Tone detectors disabled.</p> <p>5 ISModem off-hook. AOUT connected to PSTN. Tone detectors enabled.</p> <p>15 ISModem goes off-hook, begins V.253 tone event reporting and Si3000 to DAA sample pass-through becomes active. Dial tone can be heard on handset.</p> <p>20 ISModem on-hook. AOUT disabled. Tone detectors enabled.</p> <p>21 ISModem on-hook. AOUT connected to ISModem tone generators. Tone detectors enabled.</p>
+VNH = <hook>	<p>Automatic Hangup Control.</p> <p><hook> <u>Hook control description</u></p> <p>0 The ISModem retains automatic hangups as is normal in the other modes (such as hanging up the phone when the ISModem does not detect a data carrier with a given time interval).</p> <p>1 The ISModem shall disable automatic hangups in the other non-voice modes.</p> <p>2 The ISModem shall disable all hang-ups in other non-voice modes. The ISModem shall only perform a "logical" hangup (return the OK result code).</p>
+VRA = n	<p>Ringing Tone Goes Away Timer.</p> <p>The ISModem only uses this command in call origination transactions. This command sets the amount of time in 0.1 second units the ISModem shall wait between Ringing Tone before it can assume that the remote modem has gone off-hook. Default time is five seconds.</p>
+VRID = n	<p>Repeat Caller ID.</p> <p>n <u>Description</u></p> <p>0 Display Caller ID information of the last incoming call in formatted form.</p> <p>1 Display Caller ID information of the last incoming call in unformatted form.</p>
+VRN = n	<p>Ringing Tone Never Appeared Timer.</p> <p>This command sets the amount of time in seconds the ISModem will wait looking for Ringing Tone. If the ISModem does not detect Ringing Tone in this time period, the ISModem shall assume that the remote station has gone off-hook and return an OK result code. Default time is 0 seconds.</p>

Table 10. Basic AT Command Set (Command Defaults in Bold) (Continued)

Command	Action
+VRX	<p>Receive Voice Stream. Enable DTE receive of voice stream. The DCE will return a CONNECT response followed by the voice stream as defined by the +VSM command. The DTE can issue a <DLE><!> or <DLE><ESC> sequence to terminate the receive stream. The DCE will return a <DLE><ETX> followed by an OK response for <DLE><!> and <DLE><ESC> followed by an OK response for <DLE><ESC>. The DCE can be configured to terminate the stream using the DTE/DCE Inactivity Timer, which is configured using the +VIT command. The DTE will need to process any <DLE> shielded events present in the data stream. Any <DLE><DLE> sequences can be preserved to allow less overhead during playback of the stream with the +VTX command.</p>
+VSD = <sds>, <sdi>	<p>Silence Detection. <sds> Noise level sensitivity 127 Less aggressive [more sensitive, lower noise levels considered to be silence]. 128 Nominal level of sensitivity. 129 More aggressive [less sensitive, higher noise levels considered to be silence]. <sdi> sets the length of a time interval in 0.1 second units, which must contain no or little activity, before the ISModem will report (QUIET) (<DLE><q>). Default is five seconds.</p>
+VSM = n	<p>Voice Compression Method. 0 Signed PCM 1 Unsigned PCM 4 G.711 μ-Law 5 G.711 A-Law 129 ADPCM 2-bit (2 kB/s storage) 131 ADPCM 4-bit (4 kB/s storage)</p>
+VSP	<p>Voice Speakerphone State <mode> Description 0 Speakerphone AEC, AES and LEC disabled. Handset FIR filter coefficients are selected. 1 Speakerphone AEC, AES and LEC enabled. Speakerphone FIR filter coefficients are selected. The +VLS=13 command must be used in combination with this setting.</p>
+VTD = n	<p>DTMF / Tone Duration Timer. This command sets the default DTMF / tone generation duration in 10 ms units for the +VTS command. Default time is 1 second (n = 100).</p>

Table 10. Basic AT Command Set (Command Defaults in Bold) (Continued)

Command	Action
+VTS = [<freq1>, <freq2>, <dur>]	DTMF and Tone Generation. This command can be used to produce DTMF tones, single-frequency tones, and double-frequency tones. Note that the bracket characters are required for correct operation. <freq1> Frequency one, which has a range of 0, 200-3200 Hz. <freq2> Frequency two, which has a range of 0, 200-3200 Hz. <dur> Duration of the tone(s) in 10 ms units.
+VTX	Transmit Voice Samples. Used for sending digitized voice samples from host memory through the UART interface. The +VSM command determines the format of the samples. Multiple routing options are available.

4.28. Extended AT Commands

The extended AT commands are supported by the Si2494/39 and are described in Tables 11 through 13.

Table 11. Extended AT& Command Set (Command Defaults in Bold)

Command	Action
&\$	Display AT& current settings.
&D0	ESC is not used
&D1	ESC escapes to command mode from data mode if also enabled by HES U70, bit 15.
&D2	ESC assertion during a modem connection causes the modem to go on-hook and return to command mode.
&D3	ESC assertion causes ATZ command (reset and return OK result code).
&F	Restore factory default settings.
&Gn	Line connection rate limit—This command sets an upper limit on the line speed that the Si2494/39 can connect. Note that the &Hn commands may limit the line speed as well (&Gn not used for &H0 or &H1). Not all modulations support rates given by &G. Any improper setting will be ignored.
&G3	1200 bps max
&G4	2400 bps max
&G5	4.8 kbps max
&G6	7.2 kbps max
&G7	9.6 kbps max
&G8	12 kbps max
&G9	14.4 kbps max
&G10	16.8 kbps max
&G11	19.2 kbps max
&G12	21.6 kbps max
&G13	24 kbps max
&G14	26.4 kbps max
&G15	28.8 kbps max
&G16	31.2 kbps max
&G17	33.6 kbps max
&Hn	Switched network handshake mode—&Hn commands must be on a separate command line from ATD, ATA, or ATO commands.
&H0	V.90 with automatic fallback (56 kbps to 300 bps)
&H1	V.90 only (56 kbps to 28 kbps)

Table 11. Extended AT& Command Set (Command Defaults in Bold) (Continued)

Command	Action
&H2	V.34 with automatic fallback (33.6 kbps to 300 bps)
&H3	V.34 only (33.6 kbps to 2400 bps)
&H4	ITU-T V.32bis with automatic fallback (14.4 kbps to 300 bps)
&H5	ITU-T V.32bis only (14.4 kbps to 4800 bps)
&H6	ITU-T V.22bis only (2400 bps or 1200 bps)
&H7	ITU-T V.22 only (1200 bps)
&H8	Bell 212 only (1200 bps)
&H9	Bell 103 only (300 bps)
&H10	ITU-T V.21 only (300 bps)
&H11	V.23 (1200/75 bps)
&H12	V.92 with automatic fallback
&Pn	Japan pulse dialing
&P0	Configure Si2494/39 for 10 pulse-per-second pulse dialing. For Japan.
&P1	Configure Si2494/39 for 20 pulse-per-second pulse dialing. For Japan.
&Tn	Test mode
&T0	Cancel test mode (Escape to command mode to issue AT&T0). This command will also report the number of bit errors encountered on the previous &T4 or &T5 test.
&T2	Initiate ITU-T V.54 (ANALOO) test. Modulation set by &H AT command. Test loop is through the DSP (Si2494/39 device) only. ISModem [®] echoes data from TX pin (Register 0 in parallel mode) back to RX pin (Register 0 in parallel mode).
&T3	Initiate ITU-T V.54 (ANALOO) test. Modulation set by &H AT command. Test loop is through the DSP (Si2494/39), DAA interface section (Si2494/39), DAA interface (Si3018), and analog hybrid circuit (Si3018). ISModem echoes data from TX pin (Register 0 in parallel mode) back to RX pin (Register 0 in parallel mode). Phone line termination required as in Figure 1. To test only the link operation, the hybrid and AFE codec can be removed from the test loop by setting the DL bit (U62, bit 1).
&T4	Initiate transmit as originating modem with automatic data generation. Modulation, data rate, and symbol rate are set by &H, &G, and S41. Data pattern is set by the S40 register. Continues until the ATH command is sent after an escape into command mode. Data is also demodulated as in ANALOO, and any bit errors are counted to be displayed after the test using &T0.
&T5	Initiate transmit as answering modem with automatic data generation. Modulation, data rate, and symbol rate are set by &H, &G, and S41. Data pattern is set by the S40 register. Continues until the ATH command is sent after an escape into command mode. Data is also demodulated as in ANALOO, and any bit errors are counted to be displayed after the test using &T0.
&T6	Compute checksum for firmware-upgradeable section of program memory. If no firmware upgrade is installed, &T6 returns 0x4474.

Table 11. Extended AT& Command Set (Command Defaults in Bold) (Continued)

Command	Action
&Xn	Automatic determination of telephone line type.
&X0	Abort &x1 or &x2 command.
&X1	Automatic determination of telephone line type. Result code: WXYZn W: 0 = line supports DTMF dialing. 1 = line is pulse dial only. X: 0 = line supports 20 pps dialing. 1 = line supports 10 pps dialing only. Y: 0 = extension network present (PBX). 1 = outside line (PSTN) connected directly. Z: 0 = continuous dialtone. 1 = make-break dialtone. n: 0–9 (number required for outside line if Y = 0). Note: The initial number attempted for an outside line is controlled in S51.
&X2	Same as &X1, but Y result (PBX) is not tested.
*Y2A	Produce a constant answer tone (ITU-T) and return to command mode. The answer tone continues until the ATH command is received or the S7 timer expires.
&Z	Enter low-power wake-on-ring mode.

Table 12. Extended AT% Command Set (Command Defaults in Bold)

Command	Action								
%%\$	Display AT% command settings.								
%B	Report blacklist. See also S42 register.								
%Cn	Data compression								
%C0	Disable V.42bis and MNP5 data compression								
%C1	Enable V.42bis in transmit and receive paths. If MNP is selected (N2), then %C1 enables MNP5 in transmit and receive paths.								
%C2	Enable V.42bis in transmit path only.								
%C3	Enable V.42bis in receive path only.								
%On	Answer mode.								
%O1	Si2494/39 will auto-answer a call in answer mode.								
%O2	Si2494/39 will auto-answer a call in originate mode.								
%Vn	Automatic Line Status Detection. After the %V1 and %V2 commands are issued, the Si2494/39 will automatically check the telephone connection for whether or not a line is present. If a line is present, the Si2494/39 will automatically check if the line is already in use. Finally, the Si2494/39 will check line status both before going off-hook and again before dialing. %V1 uses the fixed method, and %V2 uses the adaptive method. %V0 (default) disables this feature.								
%V0	Disable automatic line-in-use detection.								
%V1	Automatic Line Status Detection—Fixed Method. Description: Before going off-hook with the ATD, ATO, or ATA commands, the Si2494/39 compares the line voltage (via LVCS) to registers NOLN (U83) and LIUS (U84): <table border="0"> <thead> <tr> <th><u>Loop Voltage</u></th> <th><u>Action</u></th> </tr> </thead> <tbody> <tr> <td>$0 \leq LVCS \leq NOLN$</td> <td>Report "NO LINE" and remain on-hook.</td> </tr> <tr> <td>$NOLN \leq LVCS \leq LIUS$</td> <td>Report "LINE IN USE" and remain on-hook.</td> </tr> <tr> <td>$LIUS \leq LVCS$</td> <td>Go off-hook and establish a modem connection.</td> </tr> </tbody> </table> Once the call has begun, the off-hook intrusion algorithm (described in "4.16.2. Off-Hook Intrusion Detection" on page 23) operates normally. In addition, the Si2494/39 will report "NO LINE" if the telephone line is completely disconnected. If the HOI bit (U77, bit 11) is set, "LINE IN USE" is reported upon intrusion.	<u>Loop Voltage</u>	<u>Action</u>	$0 \leq LVCS \leq NOLN$	Report "NO LINE" and remain on-hook.	$NOLN \leq LVCS \leq LIUS$	Report "LINE IN USE" and remain on-hook.	$LIUS \leq LVCS$	Go off-hook and establish a modem connection.
<u>Loop Voltage</u>	<u>Action</u>								
$0 \leq LVCS \leq NOLN$	Report "NO LINE" and remain on-hook.								
$NOLN \leq LVCS \leq LIUS$	Report "LINE IN USE" and remain on-hook.								
$LIUS \leq LVCS$	Go off-hook and establish a modem connection.								

Table 12. Extended AT% Command Set (Command Defaults in Bold) (Continued)

Command	Action								
%V2	<p>Automatic Line Status Detection—Adaptive Method.</p> <p>Description: Before going off-hook with the ATD, ATO, or ATA commands, the Si2494/39 compares the line voltage (via LVCS) to the NLIU (U85) register:</p> <table border="0"> <thead> <tr> <th data-bbox="300 405 803 436"><u>Loop Voltage</u></th> <th data-bbox="803 405 1481 436"><u>Action</u></th> </tr> </thead> <tbody> <tr> <td data-bbox="300 436 803 468">$0 \leq LVCS \leq (0.0625 \times NLIU)$</td> <td data-bbox="803 436 1481 468">Report "NO LINE" and remain on-hook.</td> </tr> <tr> <td data-bbox="300 468 803 499">$(0.0625 \times NLIU) < LVCS \leq (0.85 \times NLIU)$</td> <td data-bbox="803 468 1481 499">Report "LINE IN USE" and remain on-hook.</td> </tr> <tr> <td data-bbox="300 499 803 531">$(0.85 \times NLIU) < LVCS$</td> <td data-bbox="803 499 1481 531">Go off-hook and establish a modem connection.</td> </tr> </tbody> </table> <p>The NLIU register is updated every 1 ms with the minimum non-zero value of LVCS in the last 30 ms. This allows the Si2494/39 to eliminate errors due to 50/60 Hz interference and also adapt to relatively slow change in the on-hook dc reference value on the telephone line. This algorithm does not allow any non-zero values for NLIU below 0x0007. The host may also initialize NLIU prior to issuing the %V2 command. Once the call has begun, the off-hook intrusion algorithm (described in "4.16.2. Off-Hook Intrusion Detection" on page 23) operates normally. In addition, the Si2494/39 will report "NO LINE" if the telephone line is completely disconnected. If the HOI (U77, bit 11) bit is set, "LINE IN USE" is reported upon intrusion.</p>	<u>Loop Voltage</u>	<u>Action</u>	$0 \leq LVCS \leq (0.0625 \times NLIU)$	Report "NO LINE" and remain on-hook.	$(0.0625 \times NLIU) < LVCS \leq (0.85 \times NLIU)$	Report "LINE IN USE" and remain on-hook.	$(0.85 \times NLIU) < LVCS$	Go off-hook and establish a modem connection.
<u>Loop Voltage</u>	<u>Action</u>								
$0 \leq LVCS \leq (0.0625 \times NLIU)$	Report "NO LINE" and remain on-hook.								
$(0.0625 \times NLIU) < LVCS \leq (0.85 \times NLIU)$	Report "LINE IN USE" and remain on-hook.								
$(0.85 \times NLIU) < LVCS$	Go off-hook and establish a modem connection.								

Table 13. Extended AT\ Command Set (Command Defaults in Bold)

Command	Action
\\$	Display AT\ command settings.
\Bn	Character length will be automatically set in autobaud mode
\B0	6N1—six data bits, no parity, one stop bit, one start bit, eight bits total (\N0 only) ¹
\B1	7N1—seven data bits, no parity, one stop bit, one start bit, nine bits total (\N0 only) ¹
\B2	7P1—seven data bits, parity optioned by \P, one stop bit, one start bit, 10 bits total
\B3	8N1—eight data bits, no parity, one stop bit, one start bit, 10 bits total
\B5	8P1—eight data bits, parity optioned by \P, one stop bit, one start bit, 11 bits total (\N0 only)
\B6	8X1—eight data bits, one escape bit, one stop bit, one start bit, 11 bits total (enables ninth-bit escape mode)
\Nn	Asynchronous protocol
\N0	Wire mode (no error correction, no compression)
\N2	MNP reliable mode. The Si2494/39 attempts to connect with the MNP protocol. If unsuccessful, the call is dropped.
\N3	V.42 auto-reliable—The Si2494/39 attempts to connect with the V.42 protocol. If unsuccessful, the MNP protocol is attempted. If unsuccessful, wire mode is attempted.
\N4	V.42 (LAPM) reliable mode (or drop call)—Same as \N3 except that the Si2494/39 drops the call instead of connecting in MNP or wire mode.
\N5	V.42 and MNP reliable mode—The Si2494/39 attempts to connect with V.42. If unsuccessful, MNP is attempted. If MNP is unsuccessful, the call is dropped.
\Pn	Parity type will be automatically set in autobaud mode
\P0	Even
\P1	Space ¹
\P2	Odd
\P3	Mark ¹
\Qn	Modem-to-DTE flow control
\Q0	Disable all flow control—This may only be used if the DTE speed and the VF speed are guaranteed to match throughout the call.
\Q2	Use CTS only
Notes:	
<ol style="list-style-type: none"> 1. When in autobaud mode, \B0, \B1, and \P1 will not be detected automatically. The combination of \B2 and \P3 will be detected. This is compatible with seven data bits, no parity, two stop bits. Seven data bits, no parity, one stop bit may be forced by sending AT\T17\B1. 2. The autobaud feature does not detect this rate. 3. Default is \T9 if a pulldown resistor is connected to the autobaud strap pin; otherwise, the default is \T16. 	

Table 13. Extended AT Command Set (Command Defaults in Bold) (Continued)

Command	Action
\Q3	Use RTS/CTS
\Q4	Use XON/XOFF flow control for modem-to-DTE interface. Does not enable modem-to-modem flow control.
\Tn	DTE rate—Change DTE rate. When the Si2494/39 is configured in autobaud mode (default), \T0 through \T15 will lock the new baud rate and disable autobaud. When the ISOModem [®] is not in autobaud mode (the autobaud strap pin low on powerup), the result code “OK” is sent at the old DTE rate. Subsequent commands must be sent at the new rate.
\T0	300 bps
\T1	600 bps
\T2	1200 bps
\T3	2400 bps
\T4	4800 bps
\T5	7200 bps
\T6	9600 bps
\T7	12.0 kbps ²
\T8	14.4 kbps
\T9	19.2 kbps ³
\T10	38.4 kbps
\T11	57.6 kbps
\T12	115.2 kbps
\T13	230.4 kbps
\T14	245.760 kbps ²
\T15	307.200 kbps
\T16	Autobaud on³
\T17	Autobaud off; lock at current baud rate.

Notes:

1. When in autobaud mode, \B0, \B1, and \P1 will not be detected automatically. The combination of \B2 and \P3 will be detected. This is compatible with seven data bits, no parity, two stop bits. Seven data bits, no parity, one stop bit may be forced by sending AT\T17\B1.
2. The autobaud feature does not detect this rate.
3. Default is \T9 if a pulldown resistor is connected to the autobaud strap pin; otherwise, the default is \T16.

Table 13. Extended AT Command Set (Command Defaults in Bold) (Continued)

Command	Action
\U	Serial mode—causes a low pulse (25 ms) on \overline{RI} and \overline{DCD} . \overline{INT} to be the inverse of ESC. \overline{RTS} to be inverse of \overline{CTS} . Parallel mode—causes a low pulse (25 ms) on \overline{INT} . This command terminates with a \overline{RESET} .
\Vn	Connect message type
\V0	Report connect message and protocol message
\V2	Report connect message only (exclude protocol message)
\V4	Report connect and protocol message with both upstream and downstream connect rates.
<p>Notes:</p> <ol style="list-style-type: none"> 1. When in autobaud mode, \B0, \B1, and \P1 will not be detected automatically. The combination of \B2 and \P3 will be detected. This is compatible with seven data bits, no parity, two stop bits. Seven data bits, no parity, one stop bit may be forced by sending AT\T17\B1. 2. The autobaud feature does not detect this rate. 3. Default is \T9 if a pulldown resistor is connected to the autobaud strap pin; otherwise, the default is \T16. 	

Table 14. Result Codes

Numeric	Meaning	Verbal Response	X0	X1	X2	X3	X4	X5
0	Command was successful	OK	X	X	X	X	X	X
1	Link established at 300 bps or higher	CONNECT	X	X	X	X	X	X
2	Incoming ring detected	RING	X	X	X	X	X	X
3	Link dropped	NO CARRIER	X	X	X	X	X	X
4	Command failed	ERROR	X	X	X	X	X	X
5	Link establish at 1200	CONNECT 1200		X	X	X	X	X
6	Dial tone not present	NO DIALTONE			X		X	X
7	Line busy	BUSY				X	X	X
8	Remote not answering	NO ANSWER	X	X	X	X	X	X
9	Ringback detected	RINGING						X
10	Link established at 2400	CONNECT 2400		X	X	X	X	X
11	Link established at 4800	CONNECT 4800		X	X	X	X	X
12	Link established at 9600	CONNECT 9600		X	X	X	X	X
14	Link established at 19200	CONNECT 19200		X	X	X	X	X
15	Link established at 7200	CONNECT 7200		X	X	X	X	X
16	Link established at 12000	CONNECT 12000		X	X	X	X	X
17	Link established at 14400	CONNECT 14400		X	X	X	X	X
18	Link established at 16800	CONNECT 16800		X	X	X	X	X
19	Link established at 21600	CONNECT 21600		X	X	X	X	X
20	Link established at 24000	CONNECT 24000		X	X	X	X	X
21	Link established at 26400	CONNECT 26400		X	X	X	X	X
22	Link established at 28800	CONNECT 28800		X	X	X	X	X
23	Link established at 31200	CONNECT 31200		X	X	X	X	X
24	Link established at 33600	CONNECT 33600		X	X	X	X	X
30	Caller ID mark detected	CIDM	X	X	X	X	X	X
31	Hookswitch flash detected	FLASH	X	X	X	X	X	X
32	UK CID State Tone Alert Signal detected	STAS	X	X	X	X	X	X
33	Overcurrent condition	X*	X	X	X	X	X	X
40	Blacklist is full	BLACKLIST FULL (enabled via S42 register)	X	X	X	X	X	X
41	Attempted number is black-listed.	BLACKLISTED (enabled via S42 register)	X	X	X	X	X	X
42	No phone line present	NO LINE (enabled via %Vn commands)	X	X	X	X	X	X
43	Telephone line is in use	LINE IN USE (enabled via %Vn commands)	X	X	X	X	X	X
44	A polarity reversal was detected	POLARITY REVERSAL (enabled via G modifier)	X	X	X	X	X	X

*Note: X is the only verbal response code that does not follow the <CR><LF>Result Code<CR><LF> standard. There is no leading <CR><LF>.

Table 14. Result Codes (Continued)

Numeric	Meaning	Verbal Response	X0	X1	X2	X3	X4	X5
45	A polarity reversal was NOT detected	NO POLARITY REVERSAL (enabled via G modifier)	X	X	X	X	X	X
52	Link established at 56000	CONNECT 56000		X	X	X	X	X
60	Link established at 32000	CONNECT 32000		X	X	X	X	X
61	Link established at 48000	CONNECT 48000		X	X	X	X	X
63	Link established at 28000	CONNECT 28000		X	X	X	X	X
64	Link established at 29333	CONNECT 29333		X	X	X	X	X
65	Link established at 30666	CONNECT 30666		X	X	X	X	X
66	Link established at 33333	CONNECT 33333		X	X	X	X	X
67	Link established at 34666	CONNECT 34666		X	X	X	X	X
68	Link established at 36000	CONNECT 36000		X	X	X	X	X
69	Link established at 37333	CONNECT 37333		X	X	X	X	X
70	No protocol	PROTOCOL: NONE	Set with \V0 command.					
75	Link established at 75	CONNECT 75		X	X	X	X	X
77	V.42 protocol	PROTOCOL: V42	Set with \V0 command.					
79	V.42bis protocol	PROTOCOL: V42bis	Set with \V0 command.					
80	MNP2 protocol	PROTOCOL: ALTERNATE, + CLASS 2	Set with \V command.					
81	MNP3 protocol	PROTOCOL: ALTERNATE, + CLASS 3	Set with \V command.					
82	MNP4 protocol	PROTOCOL: ALTERNATE, + CLASS 4	Set with \V command.					
83	MNP5 protocol	PROTOCOL: ALTERNATE, + CLASS 5		X	X	X	X	X
90	Link established at 38666	CONNECT 38666		X	X	X	X	X
91	Link established at 40000	CONNECT 40000		X	X	X	X	X
92	Link established at 41333	CONNECT 41333		X	X	X	X	X
93	Link established at 42666	CONNECT 42666		X	X	X	X	X
94	Link established at 44000	CONNECT 44000		X	X	X	X	X
95	Link established at 45333	CONNECT 45333		X	X	X	X	X
96	Link established at 46666	CONNECT 46666		X	X	X	X	X
97	Link established at 49333	CONNECT 49333		X	X	X	X	X
98	Link established at 50666	CONNECT 50666		X	X	X	X	X
99	Link established at 52000	CONNECT 52000		X	X	X	X	X
100	Link established at 53333	CONNECT 53333		X	X	X	X	X
101	Link established at 54666	CONNECT 54666		X	X	X	X	X
102	DTMF dial attempted on a pulse dial only line	UN-OBTAINABLE NUMBER	X	X	X	X	X	X

***Note:** X is the only verbal response code that does not follow the <CR><LF>Result Code<CR><LF> standard. There is no leading <CR><LF>.

5. S-Registers

The S command allows reading (Sn?) or writing (Sn = x) the S-registers. The S-registers store values for functions that typically are rarely changed, such as timers or counters, and the ASCII values of control characters, such as carriage return. Table 15 summarizes the S-register set.

Table 15. S-Register Description

Definition				
S-Register (Decimal)	Function	Default (Decimal)	Range	Units
0	Automatic answer—Number of rings the Si2494/39 must detect before answering a call. 0 disables auto answer.	0	0–255	Rings
1	Ring counter.	0	0–255	Rings
2	ESC code character.	43 (+)	0–255	ASCII
3	Carriage return character.	13 (CR)	0–255	ASCII
4	Linefeed character.	10 (LF)	0–255	ASCII
5	Backspace character.	08 (BS)	0–255	ASCII
6	Dial tone wait timer—Number of seconds the Si2494/39 waits before blind dialing. Only applicable if blind dialing is enabled (X0, X1, X3).	02	0–255	seconds
7	Carrier wait timer—Number of seconds the Si2494/39 waits for carrier before timing out. This register also sets the number of seconds the modem waits for ring-back when originating a call before hanging up. This register also sets the number of seconds the answer tone will continue while using the AT*Y2A command.	80	0–255	seconds
8	Dial pause timer for , and < dial command modifiers.	02	0–255	seconds
9	Carrier presence timer—Time after a loss of carrier that a carrier must be detected before reactivating DCD. S9 is referred to as “carrier loss debounce time.”	06	1–255	0.1 second
10	Carrier loss timer—Time the carrier must be lost before the Si2494/39 disconnects. Setting 255 disables disconnect entirely. If S10 is less than S9, even a momentary loss of carrier causes a disconnect.	14	1–255	0.1 second
12	Escape code guard timer—Minimum guard time required before and after “+++” for the Si2494/39 to recognize a valid escape sequence.	50	1–255	0.02 second
14	Wait for dial tone delay value (in relation to the W dial modifier). Starts when “W” is executed in the dial string.	12	0–255	seconds

Table 15. S-Register Description (Continued)

Definition				
S-Register (Decimal)	Function	Default (Decimal)	Range	Units
24	Sleep Inactivity Time—Sets the time that the modem operates in normal power mode with no activity on the serial port, parallel port, or telephone line before entering low-power sleep mode. This feature is disabled if the timer is set to 0.	0	0–255	seconds
30	Disconnect Activity Timer—Sets the length of time that the modem stays online before disconnecting with no activity on the serial port, parallel port, or telephone line (Ring, hookswitch flash, or caller ID). This feature is disabled if set to 0.	0	0–255	minutes
38	Hang Up Delay Time—Maximum delay between receipt of ATH0 command and hang up. If time out occurs before all data can be sent, the NO CARRIER (3) result code is sent (operates in V.42 mode only). “OK” response is sent if all data is transmitted before timeout. S38 = 255 disables timeout and modem disconnects only if data is successfully sent or carrier is lost.	20	0–255	seconds
40	Data Pattern—Data pattern generated during &T4 and &T5 transmit tests. 0 = All spaces (0s) 1 = All marks (1s) 2 = Random data	0	0–2	
41	V.34 symbol rate - Symbol rate for V.34 when using the &T4 and &T5 commands. 0 = 2400 symbols/second 1 = 2743 symbols/second 2 = 2800 symbols/second 3 = 3000 symbols/second 4 = 3200 symbols/second 5 = 3429 symbols/second A valid combination of symbol rate (S41) and data rate (&G) must be selected. <u>Symbol Rate</u> <u>Allowable Data Rates</u> 2400 2400–21600 2743 4800–26400 2800 4800–26400 3000 4800–28800 3200 4800–31200 3429 4800–33600	0	0–5	

Table 15. S-Register Description (Continued)

Definition				
S-Register (Decimal)	Function	Default (Decimal)	Range	Units
42	Blacklisting—The Si2494/39 will not dial the same number more than two times in three minutes. An attempt to dial a third time within three minutes will result in a “BLACKLISTED” result code. If the blacklist memory is full, any dial to a new number will result in a “BLACKLIST FULL” result code. Numbers are added to the blacklist only if the modem connection fails. The %B command will list the numbers on the blacklists. 0 = disabled 1 = enabled	0 (disabled)	0–1	
43	Dial Attempts to Blacklist. When blacklisting is enabled with S42, this value controls the number of dial attempts that will result in a number being blacklisted.	4	0–4	—
44	Blacklist Timer. Period during which blacklisting is active.	180	0–255	seconds
50	Minimum on-hook time—Modem will remain on-hook for S50 seconds. Any attempt to go off-hook will be delayed until this timer expires.	3	0–255	seconds
51	Number to start checking for an outside line on a PBX. See &X command for details.	1	0–9	—

6. User-Access Registers (U-Registers)

U-Registers are 16-bit registers written by the AT:Uaa command and read by the AT:R (read all U-Registers) or AT:Raa (read U-Register aa) commands (see the AT command list in Table 13 on page 46). Many aspects of the modem's and DAA's behavior can be enabled/disabled, configured, monitored, and/or modified through U-Registers; however, most of them will not be needed in normal use.

There are two types of U-Registers. The first represents a single 16-bit term, such as a filter coefficient, threshold, delay, or other quantity. These registers can be read from or written to as a single 16-bit value. The second type of U-Register is bit-mapped. Bit-mapped registers are written and/or read in hexadecimal, but each bit or combination of bits in the register represents an independent value or status information. These individual bits are used to enable or disable features and indicate states.

Some U-Registers are reserved and not available to the user. Therefore, there are gaps in the available U-Register address map. Additionally, some bits within available U-Registers are reserved. Any attempt to write a non-zero value to a reserved U-Register or bit may cause unpredictable modem operation.

With over 100 U-Registers, the Si2494/39 offers an unprecedented level of programmability for a controller-based modem. A detailed list of these registers and their use is beyond the scope of this data sheet. Refer to "AN93: ISOmodem[®] Chipset Family Designer's Guide" for details.

7. Pin Descriptions: Si2494/39



Table 16. Si2494/39 Pin Descriptions

Pin #	Pin Name	Description
1	GPIO1	General Purpose Input Output #1.
2	$\overline{\text{FSYNC}}$	Frame Sync/Data Bit. Frame Sync output to codec in serial mode.
3	CLKOUT	Clock Output. Clock output in serial mode.
4	NC	No Connect.
5	VDD	Digital Supply Voltage. Provides the 3.3V supply voltage to the Si2494/39.
6	GND	Ground. Connects to the system digital ground.
7	VREG	Regulator Voltage Reference. Connects to an external capacitor and serves as the reference for the internal voltage regulator.
8	SDI	Serial Data In. Serial Data In (to codec) output in serial mode.
9	SDO	Serial Data Out. Serial Data Output (from codec) input in serial mode.
10	EESDI	EEPROM Serial Data Input. Serial Data In to SPI EEPROM.
11	EESDO	EEPROM Serial Data Output. Serial Data Out from SPI EEPROM.

Table 16. Si2494/39 Pin Descriptions (Continued)

Pin #	Pin Name	Description
12	$\overline{\text{EECS}}$	EEPROM Chip Select. Active low read/write enable for SPI EEPROM.
13	EECLK	EEPROM Clock. Clock for SPI EEPROM.
14	AOUTb	Audio Output B. PWM audio output B when differential audio output is enabled.
15	AOUT	Audio Output. PWM audio output.
16	$\overline{\text{RESET}}$	Reset Input. An active low input that is used to reset all control registers to a defined initialized state.
17	C2A	Isolation Capacitor 2A. Connects to one side of the isolation capacitor, C2.
18	C1A	Isolation Capacitor 1A. Connects to one side of the isolation capacitor, C1.
19	$\overline{\text{RI}}$	Ring Indicator. The RI on (active low) indicates the presence of an ON segment of a ring signal on the telephone line.
20	GPIO11, A0	GPIO/Address Bit 0. General purpose input output pin 11. Address Enable in parallel mode.
21	$\overline{\text{CTS}}$, SCLKC, $\overline{\text{CS}}$	Clear to Send/Serial Data Clock/Chip Select. Signals that the Si2494/39 is ready to receive more digital data on the TXD pin in data mode. Serial data clock input in SPI mode. Active low chip select in parallel mode.
22	RXD/MISO/ $\overline{\text{RD}}$	Receive Data/Master In Slave Out/Read Enable. Data output to DTE TXD pin in serial mode. Serial data output from modem in SPI mode. Active low read enable pin in parallel mode.
23	TXD/MOSI/ $\overline{\text{WR}}$	Transmit Data/Master Out Slave In/Write Enable. Data input from DTE TXD pin in serial mode. Serial data input to modem in SPI mode. Active low write enable pin in parallel mode.
24	$\overline{\text{RTS}}$, $\overline{\text{SS}}$, D7	Request to Send/SPI Slave Select/Data Bit. Active low request to send input used for flow control in UART mode. Active low slave select in SPI mode. Bidirectional parallel bus data bit 7 in parallel mode.
25	GND	Ground. Connects to the system digital ground.
26	VDD	Digital Supply Voltage. Provides the 3.3V supply voltage to the Si2494/39,
27	NC	No connect.

Table 16. Si2494/39 Pin Descriptions (Continued)

Pin #	Pin Name	Description
28	$\overline{\text{DCD}}$, D6	Carrier Detect/Data Bit. Active low carrier detect in serial mode. Bidirectional parallel bus data bit 6 in parallel mode.
29	ESC, D5	Escape/Data Bit. Hardware escape in serial mode. Bidirectional parallel bus data bit 5 in parallel mode.
30	GPIO24, D4	General Purpose Input Output Bit/Data Bit. General purpose input output bit 24. Bidirectional parallel bus data bit 4 in parallel mode.
31	GPIO25, D3	General Purpose Input Output Bit/Data Bit. General purpose input output bit 25. Bidirectional parallel bus data bit 3 in parallel mode.
32	GPIO16, D2	General Purpose Input Output Bit/Data Bit. General purpose input output bit 16. Bidirectional parallel bus data bit 2 in parallel mode.
33	GPIO17, D1	General Purpose Input Output Bit/Data Bit. General purpose input output bit 17. Bidirectional parallel bus data bit 1 in parallel mode.
34	GPIO18, D0	General Purpose Input Output Bit/Data Bit. General purpose input output bit 18. Bidirectional parallel bus data bit 0 in parallel mode.
35	$\overline{\text{INT}}$	Interrupt Output. Active low interrupt output.
36	CLKIN, XTAL1	Clock Input/Crystal Oscillator Pin. Provides support for parallel resonant AT cut crystals. A 4.9152 MHz or 32.768 kHz crystal or a 32.768 kHz or 4.9152 or 27 MHz clock on XTAL1 is required.
37	XTALO	Crystal Oscillator Pin. Serves as the output of the crystal amplifier.
38	NC	No Connect.

8. Pin Descriptions: Si3018



Table 17. Si3018 Pin Descriptions

Pin #	Pin Name	Description
1	QE	Transistor Emitter. Connects to the emitter of Q3.
2	DCT	DC Termination. Provides dc termination to the telephone network.
3	RX	Receive Input. Serves as the receive side input from the telephone network.
4	IB	Internal Bias. Provides a bias voltage to the device.
5	C1B	Isolation Capacitor 1B. Connects to one side of isolation capacitor C1 and communicates with the system side.
6	C2B	Isolation Capacitor 2B. Connects to one side of isolation capacitor C2 and communicates with the system side.
7	VREG	Voltage Regulator. Connects to an external capacitor to provide bypassing for an internal power supply.
8	RNG1	Ring 1. Connects through a resistor to the RING lead of the telephone line. Provides the ring and caller ID signals to the Si2494/39.
9	RNG2	Ring 2. Connects through a resistor to the TIP lead of the telephone line. Provides the ring and caller ID signals to the Si2494/39.
10	VREG2	Voltage Regulator 2. Connects to an external capacitor to provide bypassing for an internal power supply.
11	SC	SC Connection. Enables external transistor network. Should be tied through a 0 Ω resistor to I _{GND} .
12	QE2	Transistor Emitter 2. Connects to the emitter of Q4.
13	QB	Transistor Base. Connects to the base of transistor Q4.
14	DCT3	DC Termination 3. Provides the dc termination to the telephone network.
15	IGND	Isolated Ground. Connects to ground on the line-side interface.
16	DCT2	DC Termination 2. Provides dc termination to the telephone network.

9. Ordering Guide

Chipset	Max Speed	System-Side Package	System-Side	Line-Side	Temp Range
Si2494	56 kbps	38 QFN	Si2494-A-FM	Si3018-F-FS	0 to 70 °C
Si2494	56 kbps	38 QFN	Si2494-A-GM	Si3018-F-GS	-40 to 85 °C
Si2439	33.6 kbps	38 QFN	Si2439-A-FM	Si3018-F-FS	0 to 70 °C
Si2439	33.6 kbps	38 QFN	Si2439-A-GM	Si3018-F-GS	-40 to 85 °C

Note: Add an "R" at the end of the device to denote tape and reel option.

10. Package Markings (Top Markings)

10.1. Si2494 Top Marking



Figure 9. Si2494-A-FM Top Marking



Figure 10. Si2494-A-GM Top Marking

10.2. Si2439 Top Marking

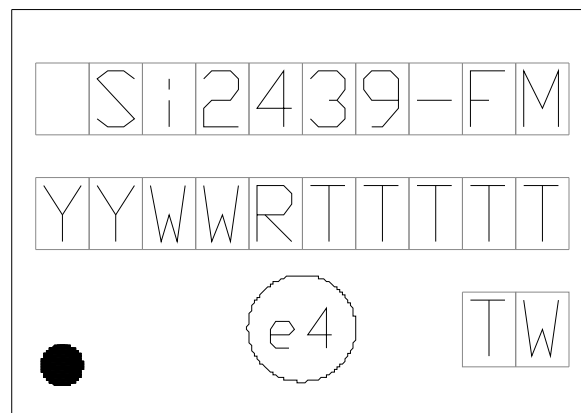

Figure 11. Si2439-A-FM Top Marking



Figure 12. Si2439-A-GM

10.3. Si2494/39 Top Markings Explanation

Mark Method:	YAG Laser	
Line 1 Marking:	Part Number	
Line 2 Marking:	YY=Current Year WW=Work Week	Assigned by the Assembly House. Corresponds to the last significant digit of the year and work week of the mold date.
	R = Die Revision	
	T...T=Trace Code	
Line 3 Marking:	Circle=0.5 mm Diameter (Bottom-Left Justified)	Pin 1 identifier.
	e3 Circle	Pb-Free Symbol
	TW=Assembly Country Code	

10.4. Si3018 Top Marking

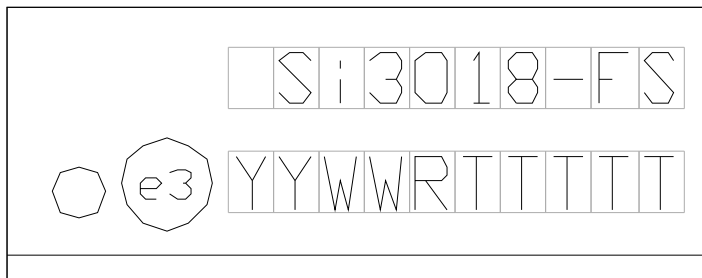

Figure 13. Si3018-F-FS Top Marking



Figure 14. Si3018-F-GS Top Marking

10.5. Si3018 Top Markings Explanation

Mark Method:	YAG Laser	
Line 1 Marking:	Part Number	
Line 2 Marking:	YY=Current Year WW=Work Week	Assigned by the Assembly House. Corresponds to the last significant digit of the year and work week of the mold date.
	R = Die Revision	
	T...T=Trace Code	
	Circle=0.5 mm Diameter (Bottom-Left Justified)	Pin 1 identifier.
	e3 Circle	Pb-Free Symbol

11. Package Outline: 38-Pin QFN

Figure 15 illustrates the package details for the Si2494/39. Table 18 lists the values for the dimensions shown in the illustration.



Figure 15. 38-Pin Quad Flat No-Lead Package (QFN)

Table 18. Package Diagram Dimensions^{1,2,3}

Symbol	Millimeters		
	Min	Nom	Max
A	0.75	0.85	0.95
A1	0.00	0.01	0.05
b	0.18	0.23	0.30
D	5.00 BSC.		
D2	3.10	3.20	3.30
e	0.50 BSC.		
E	7.00 BSC.		
E2	5.10	5.20	5.30
L	0.35	0.45	0.55
L1	0.03	0.05	0.08
aaa	—	—	0.10
bbb	—	—	0.10
ccc	—	—	0.08
ddd	—	—	0.10
Notes:			
1. All dimensions shown are in millimeters (mm) unless otherwise noted.			
2. Dimensioning and Tolerancing per ANSI Y14.5M-1982.			
3. Recommended card reflow profile is per the JEDEC/IPC J-STD-020 specification for Small Body Components.			

12. 38-Pin QFN Land Pattern

Figure 16 shows the recommended land pattern for the Si2494/39 QFN-38 package. Table 19 lists the values for the dimensions shown in the illustration.

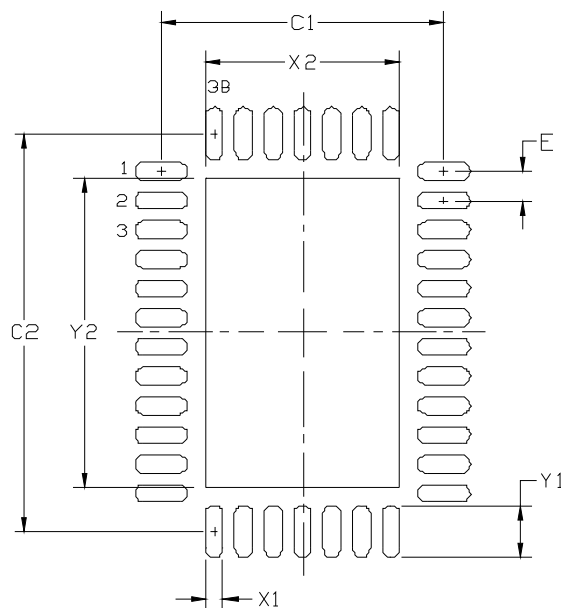

Figure 16. QFN-38 Land Pattern Drawing

Table 19. QFN-38 PCB Land Pattern Dimensions

Dimension	Feature	Min	Max
C1	Pad column spacing	4.70	4.80
C2	Pad row spacing	6.70	6.80
E	Pad pitch	0.50 BSC	
X1	Pin pad width	0.20	0.30
X2	Thermal pad width	3.20	3.30
Y1	Pin pad width	0.80	0.90
Y2	Thermal pad length	5.20	5.30

Notes:

General

1. All dimensions shown are in millimeters (mm) unless otherwise noted.
2. This Land Pattern Design is based on the IPC-7351 guidelines.

Solder Mask Design

1. All metal pads are to be non-solder mask defined (NSMD). Clearance between the solder mask and the metal pad is to be 60 μm minimum, all the way around the pad.

Stencil Design

1. A stainless steel, laser-cut and electro-polished stencil with trapezoidal walls should be used to assure good solder paste release.
2. The stencil thickness should be 0.125 mm (5 mils).
3. The ratio of stencil aperture to land pad size should be 1:1 for all perimeter pads
4. A 3x5 array of 0.90 mm square openings on 1.10 mm pitch should be used for the center ground pad.

Card Assembly

1. A No-Clean, Type-3 solder paste is recommended.
2. The recommended card reflow profile is per the JEDEC/IPEC J-STD-020 specification for Small Body Components.

13. Package Outline: 16-Pin SOIC

Figure 17 illustrates the package details for the Si3018 16-pin packaging option. Table 20 lists the values for the dimensions shown in the illustration.

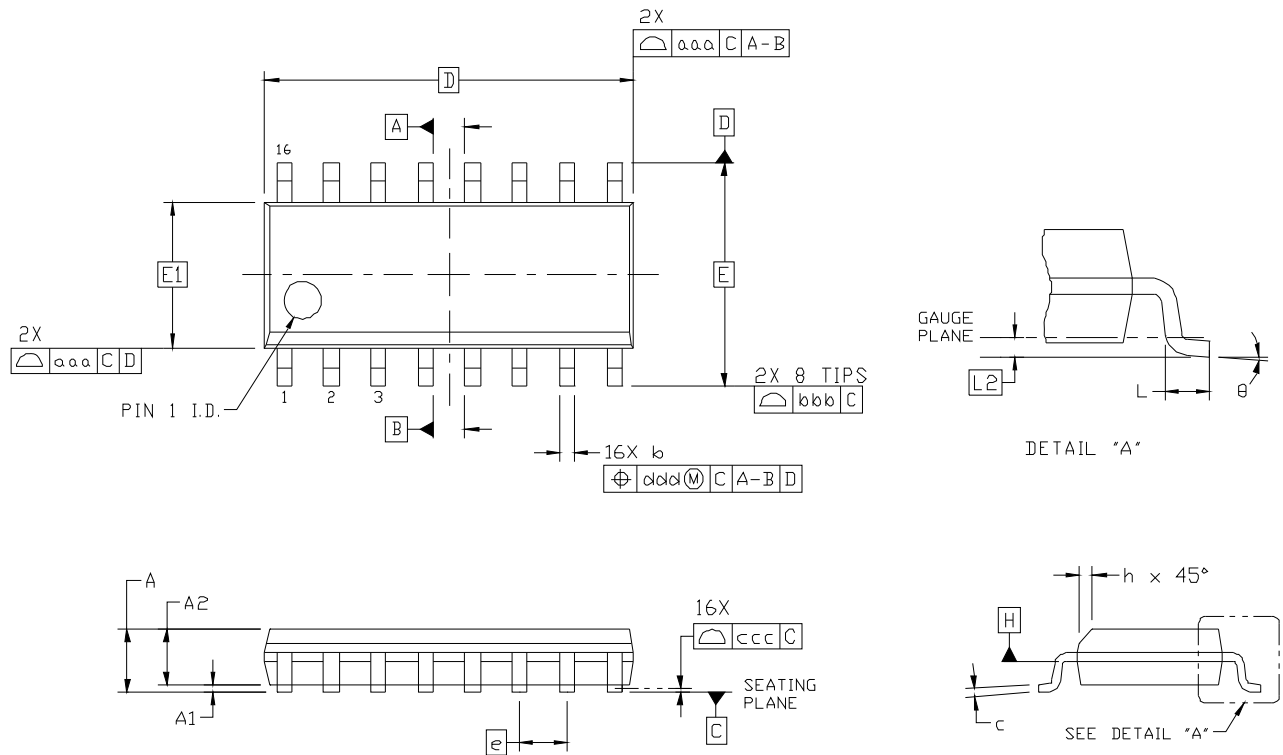

Figure 17. 16-Pin Small Outline Integrated Circuit (SOIC) Package

Table 20. Package Diagram Dimensions

Dimension	Min	Max
A	—	1.75
A1	0.10	0.25
A2	1.25	—
b	0.31	0.51
c	0.17	0.25
D	9.90 BSC	
E	6.00 BSC	
E1	3.90 BSC	
e	1.27 BSC	
L	0.40	1.27
L2	0.25 BSC	
h	0.25	0.50
θ	0°	8°
aaa	0.10	
bbb	0.20	
ccc	0.10	
ddd	0.25	
Notes:		
<ol style="list-style-type: none"> 1. All dimensions shown are in millimeters (mm) unless otherwise noted. 2. Dimensioning and Tolerancing per ANSI Y14.5M-1994. 3. This drawing conforms to the JEDEC Solid State Outline MS-012, Variation AC. 4. Recommended card reflow profile is per the JEDEC/IPC J-STD-020 specification for Small Body Components. 		

14. 16-Pin SOIC Land Pattern

Figure 18 illustrates the recommended land pattern for the Si2494/39 16-Pin SOIC. Table 21 lists the values for the dimensions shown in the illustration.



Figure 18. 16-Pin SOIC Land Pattern Diagram

Table 21. 16-Pin SOIC Land Pattern Dimensions

Dimension	Feature	(mm)
C1	Pad Column Spacing	5.40
E	Pad Row Pitch	1.27
X1	Pad Width	0.60
Y1	Pad Length	1.55

Notes:

General

1. All dimensions shown are in millimeters (mm) unless otherwise noted.
2. Dimensioning and Tolerancing per ASME Y14.5M-1994.
3. This Land Pattern Design is based on the IPC-7351 guidelines.
4. All dimensions shown are at Maximum Material Condition (MMC). Least Material Condition (LMC) is calculated based on a Fabrication Allowance of 0.05 mm.

Solder Mask Design

5. All metal pads are to be non-solder mask defined (NSMD). Clearance between the solder mask and the metal pad is to be 60 μm minimum, all the way around the pad.

Stencil Design

6. A stainless steel, laser-cut and electro-polished stencil with trapezoidal walls should be used to assure good solder paste release.
7. The stencil thickness should be 0.125 mm (5 mils).
8. The ratio of stencil aperture to land pad size should be 1:1.

Card Assembly

9. A No-Clean, Type-3 solder paste is recommended.
10. The recommended card reflow profile is per the JEDEC/IPC J-STD-020 specification for Small Body Components.

NOTES:



Smart.
Connected.
Energy-Friendly.



Products
www.silabs.com/products



Quality
www.silabs.com/quality



Support and Community
community.silabs.com

Disclaimer

Silicon Labs intends to provide customers with the latest, accurate, and in-depth documentation of all peripherals and modules available for system and software implementers using or intending to use the Silicon Labs products. Characterization data, available modules and peripherals, memory sizes and memory addresses refer to each specific device, and "Typical" parameters provided can and do vary in different applications. Application examples described herein are for illustrative purposes only. Silicon Labs reserves the right to make changes without further notice to the product information, specifications, and descriptions herein, and does not give warranties as to the accuracy or completeness of the included information. Without prior notification, Silicon Labs may update product firmware during the manufacturing process for security or reliability reasons. Such changes will not alter the specifications or the performance of the product. Silicon Labs shall have no liability for the consequences of use of the information supplied in this document. This document does not imply or expressly grant any license to design or fabricate any integrated circuits. The products are not designed or authorized to be used within any FDA Class III devices, applications for which FDA premarket approval is required or Life Support Systems without the specific written consent of Silicon Labs. A "Life Support System" is any product or system intended to support or sustain life and/or health, which, if it fails, can be reasonably expected to result in significant personal injury or death. Silicon Labs products are not designed or authorized for military applications. Silicon Labs products shall under no circumstances be used in weapons of mass destruction including (but not limited to) nuclear, biological or chemical weapons, or missiles capable of delivering such weapons. Silicon Labs disclaims all express and implied warranties and shall not be responsible or liable for any injuries or damages related to use of a Silicon Labs product in such unauthorized applications.

Trademark Information

Silicon Laboratories Inc.®, Silicon Laboratories®, Silicon Labs®, SiLabs® and the Silicon Labs logo®, Bluegiga®, Bluegiga Logo®, ClockBuilder®, CMEMS®, DSPLL®, EFM®, EFM32®, EFR, Ember®, Energy Micro, Energy Micro logo and combinations thereof, "the world's most energy friendly microcontrollers", Ember®, EZLink®, EZRadio®, EZRadioPRO®, Gecko®, Gecko OS, Gecko OS Studio, ISOModem®, Precision32®, ProSLIC®, Simplicity Studio®, SiPHY®, Telegesis, the Telegesis Logo®, USBXpress®, Zentri, the Zentri logo and Zentri DMS, Z-Wave®, and others are trademarks or registered trademarks of Silicon Labs. ARM, CORTEX, Cortex-M3 and THUMB are trademarks or registered trademarks of ARM Holdings. Keil is a registered trademark of ARM Limited. Wi-Fi is a registered trademark of the Wi-Fi Alliance. All other products or brand names mentioned herein are trademarks of their respective holders.



Silicon Laboratories Inc.
400 West Cesar Chavez
Austin, TX 78701
USA

<http://www.silabs.com>