

Product Description

The SPF5122Z is a high performance pHEMT MMIC LNA designed for operation from 50 MHz to 4000 MHz. The on-chip active bias network provides stable current over temperature and process threshold voltage variations. The SPF5122Z offers ultra-low noise figure and high linearity performance in a gain block configuration. Its single-supply operation and integrated matching networks make implementation remarkably simple. A high maximum input power specification make it ideal for high dynamic range receivers.

Optimum Technology Matching® Applied

- GaAs HBT
- GaAs MESFET
- InGaP HBT
- SiGe BiCMOS
- Si BiCMOS
- SiGe HBT
- GaAs pHEMT
- Si CMOS
- Si BJT
- GaN HEMT
- InP HBT
- RF MEMS
- LDMOS

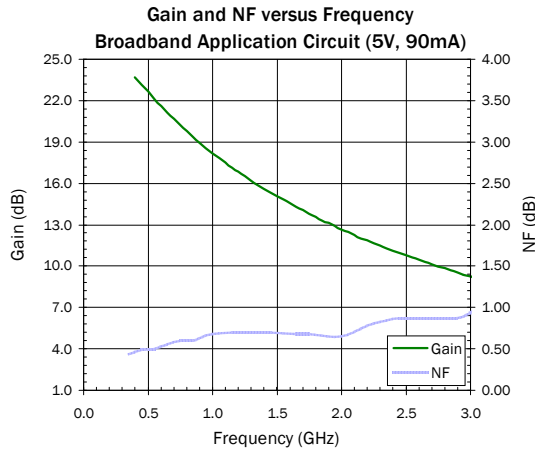

Features

- Ultra-Low Noise Figure=0.60 dB at 900 MHz
- Gain=18.9 dB at 900 MHz
- High Linearity: OIP3=40.5 dBm at 1900 MHz
- Channel Power=13.4 dBm (-65 dBc IS95 ACPR, 880 MHz)
- P_{1dB}=23.4 dBm at 1900 MHz
- Single-Supply Operation: 5V at I_{DQ}=90 mA
- Flexible Biasing Options: 3-5V, Adjustable Current
- Broadband Internal Matching

Applications

- Cellular, PCS, W-CDMA, ISM, WiMAX Receivers
- PA Driver Amplifier
- Low Noise, High Linearity Gain Block Applications

Parameter	Specification			Unit	Condition
	Min.	Typ.	Max.		
Small Signal Power Gain	17.2	18.9	20.2	dB	0.9GHz
	11.2	12.2	14.4	dB	1.96GHz
Output Power at 1dB Compression	20.8	22.8		dBm	0.9GHz
	21.4	23.4		dBm	1.9GHz
Output Third Order Intercept Point	35.1	38.1		dBm	0.9GHz
	37.2	40.5		dBm	1.9GHz
Noise Figure		0.59	0.85	dB	0.9GHz
		0.65	0.9	dB	1.9GHz
Input Return Loss	10	14.3		dB	0.9 GHz
		21		dB	1.9GHz
Output Return Loss	14	17		dB	0.9GHz
		13		dB	1.9GHz
Reverse Isolation		24.1		dB	0.9GHz
		18.4		dB	1.9GHz
Device Operating Voltage		5.00	5.25	V	
Device Operating Current	75	90	105	mA	Quiescent
Thermal Resistance		65		°C/W	Junction to lead

Test Conditions: V_D=5V, I_{DQ}=90mA, OIP₃ Tone Spacing=1MHz, P_{OUT} per tone=0 dBm, Z_S=Z_L=50Ω, 25 °C, Broadband Application Circuit

Absolute Maximum Ratings

Parameter	Rating	Unit
Max Device Current (I_D)	120	mA
Max Device Voltage (V_D)	5.5	V
Max RF Input Power	27	dBm
Max Dissipated Power	660	mW
Max Junction Temperature (T_J)	150	°C
Operating Temperature Range (T_L)	-40 to + 85	°C
Max Storage Temperature	-65 to +150	°C
ESD Rating - Human Body Model (HBM)	Class 1B	
Moisture Sensitivity Level (MSL)	MSL 1	



Caution! ESD sensitive device.

Exceeding any one or a combination of the Absolute Maximum Rating conditions may cause permanent damage to the device. Extended application of Absolute Maximum Rating conditions to the device may reduce device reliability. Specified typical performance or functional operation of the device under Absolute Maximum Rating conditions is not implied.

The information in this publication is believed to be accurate and reliable. However, no responsibility is assumed by RF Micro Devices, Inc. ("RFMD") for its use, nor for any infringement of patents, or other rights of third parties, resulting from its use. No license is granted by implication or otherwise under any patent or patent rights of RFMD. RFMD reserves the right to change component circuitry, recommended application circuitry and specifications at any time without prior notice.



RFMD Green: RoHS compliant per EU Directive 2002/95/EC, halogen free per IEC 61249-2-21, < 1000ppm each of antimony trioxide in polymeric materials and red phosphorus as a flame retardant, and <2% antimony in solder.

Operation of this device beyond any one of these limits may cause permanent damage. For reliable continuous operation, the device voltage and current must not exceed the maximum operating values specified in the table on page one.

Bias Conditions should also satisfy the following expression:

$$I_D V_D < (T_J - T_L) / R_{TH, j-l} \text{ and } T_L = T_{LEAD}$$

Typical RF Performance - Broadband Application Circuit with $V_D=5V$, $I_D=90mA$

Parameter	Unit	0.1 GHz*	0.4 GHz	0.9 GHz	1.5 GHz	1.9 GHz	2.2 GHz	2.5 GHz	3.5 GHz	3.8 GHz
Small Signal Gain	dB	27.0	24.0	19.0	15.0	13.0	12.0	11.0	6.0	7.0
Noise Figure	dB	0.42	0.47	0.59	0.70	0.64	0.73	0.86	1.35	1.27
Output IP3	dBm	33.0	36.0	38.0	39.5	40.5	41.0	41.5	40.5	41.5
Output P1dB	dBm	22.3	22.7	23.0	23.2	23.4	23.7	23.9	22.2	22.9
Input Return Loss	dB	-9.5	-10.0	-14.5	-20.0	-21.0	-22.0	-22.5	-15.0	-11.5
Output Return Loss	dB	-29.0	-19.5	-17.0	-14.0	-13.0	-12.5	-12.5	-7.5	-15.5
Reverse Isolation	dB	-32.0	-29.0	-24.0	-20.0	-18.5	-17.5	-16.5	-15.5	-13.5

Test Conditions: $V_D=5V$, $I_{DQ}=90mA$, OIP₃ Tone Spacing=1MHz, P_{OUT} per tone=0dBm, $T_L=25^\circ C$, $Z_S=Z_L=50\Omega$, *Bias Tee Data @ 100MHz

1. Input RL can be improved in the 800MHz to 1000MHz band by adding a series inductor between the DC block and device input.

Typical RF Performance - Broadband Application Circuit with $V_D=3V$, $I_D=58mA$

Parameter	Unit	0.1 GHz*	0.4 GHz	0.9 GHz	1.5 GHz	1.9 GHz	2.2 GHz	2.5 GHz	3.5 GHz	3.8 GHz
Small Signal Gain	dB	26.0	23.0	18.5	14.5	12.5	11.5	10.5	6.0	6.5
Noise Figure	dB	0.35	0.44	0.58	0.65	0.61	0.69	0.79	1.25	1.19
Output IP3	dBm	31.5	33.0	34.5	36.0	36.5	37.0	37.5	37.0	37.5
Output P1dB	dBm	18.8	18.9	19.1	19.4	19.9	20.2	20.1	18.9	19.2
Input Return Loss	dB	-8.0	-9.0	-13.0	-16.5	-18.5	-19.0	-19.0	-13.5	-10.0
Output Return Loss	dB	-26.0	-28.5	-23.5	-18.0	-16.5	-16.0	-15.5	-9.0	-14.0
Reverse Isolation	dB	-31.0	-28.0	-23.0	-19.0	-17.5	-16.0	-15.0	-14.5	-12.5

Test Conditions: $V_D=3V$, $I_{DQ}=58mA$, OIP₃ Tone Spacing=1MHz, P_{OUT} per tone=0dBm, $T_L=25^\circ C$, $Z_S=Z_L=50\Omega$, *Bias Tee Data @ 100MHz

1. Input RL can be improved in the 800MHz to 1000MHz band by adding a series inductor between the DC block and device input.

Typical RF Performance - Broadband Application Circuit with $V_D=5V$, $I_D=90mA$

NF versus Frequency

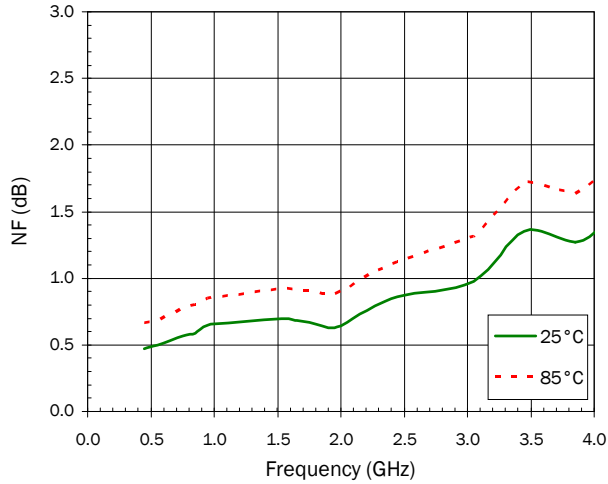

OIP₃ versus Frequency
(0 dBm/tone, 1 MHz spacing)

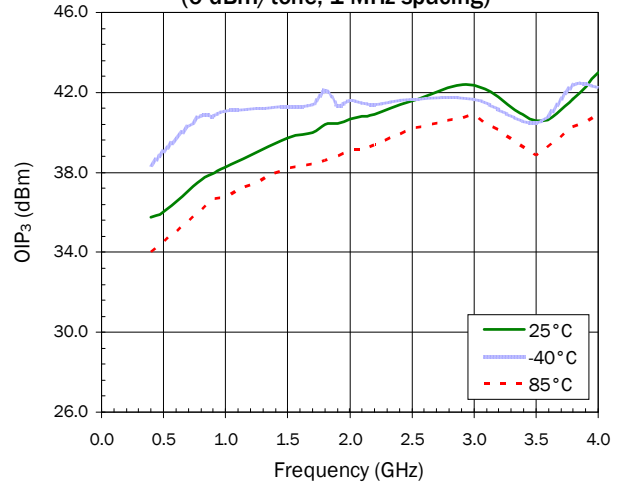

P_{1dB} versus Frequency

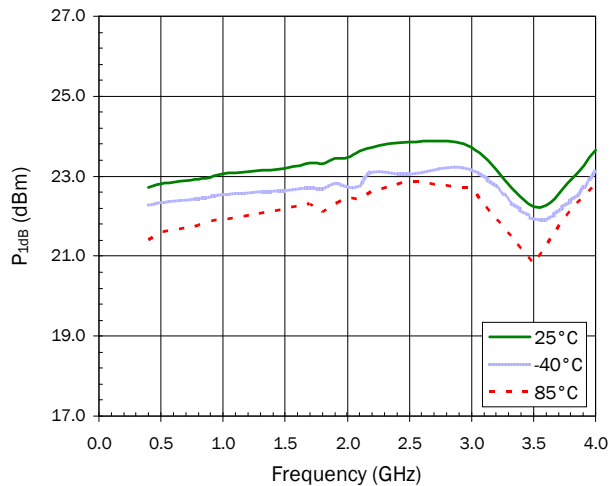

Device Current versus Voltage

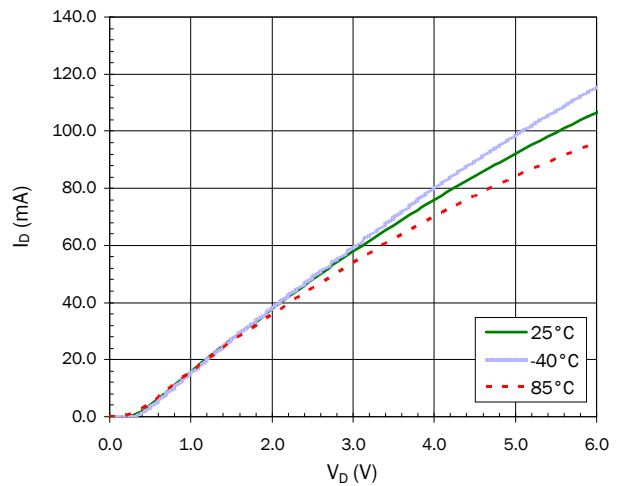

Typical RF Performance - Broadband Application Circuit with $V_D=5V$, $I_D=90mA$

S11 versus Frequency

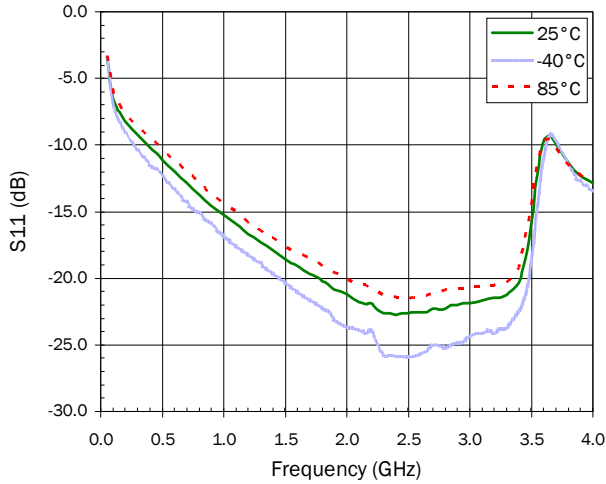

S21 versus Frequency

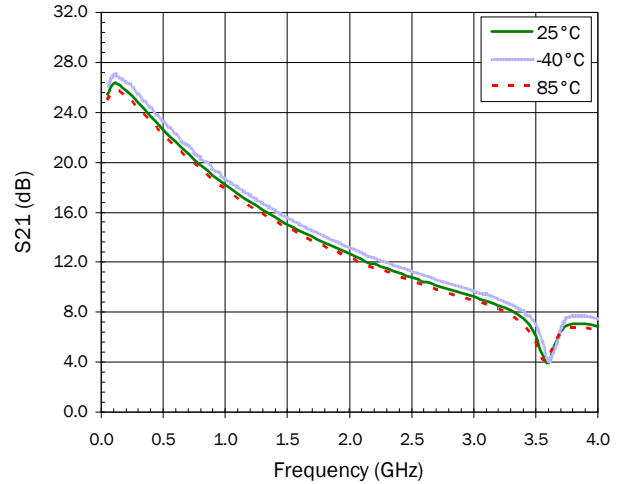

S12 versus Frequency

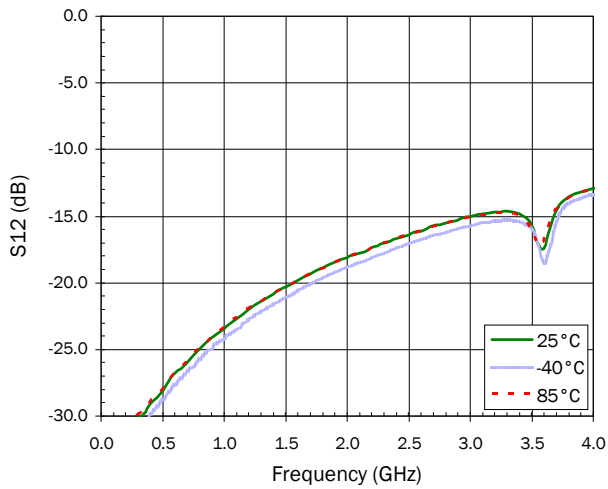

S22 versus Frequency

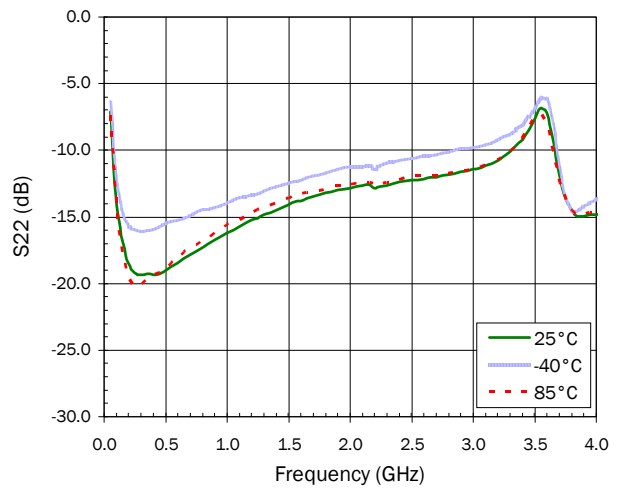

Typical RF Performance - Broadband Application Circuit with $V_D=5V$, $I_D=90mA$

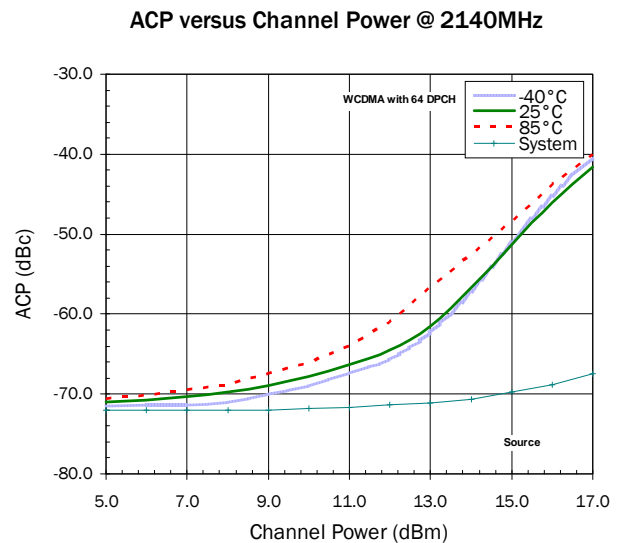
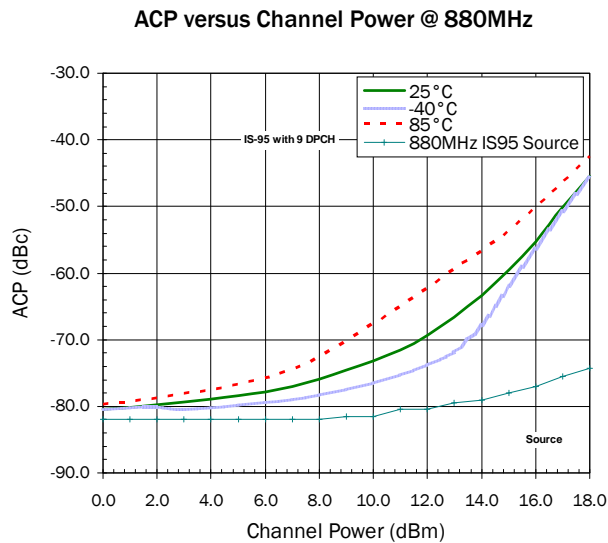
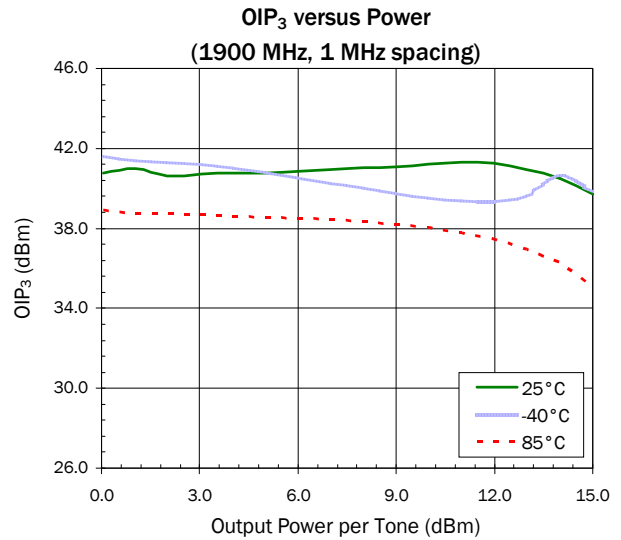
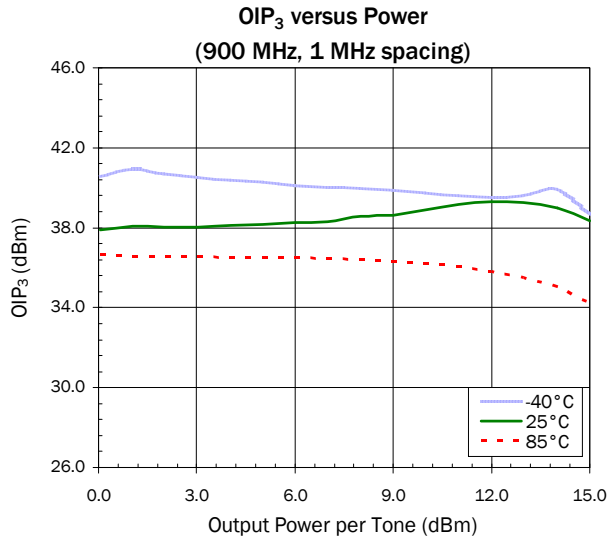

Typical RF Performance - Broadband Application Circuit with $V_D=3V$, $I_D=58mA$

NF versus Frequency

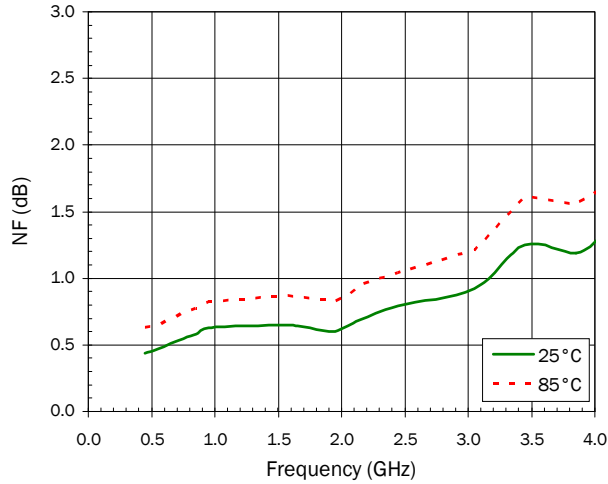

OIP₃ versus Frequency
(0 dBm/tone, 1 MHz spacing)

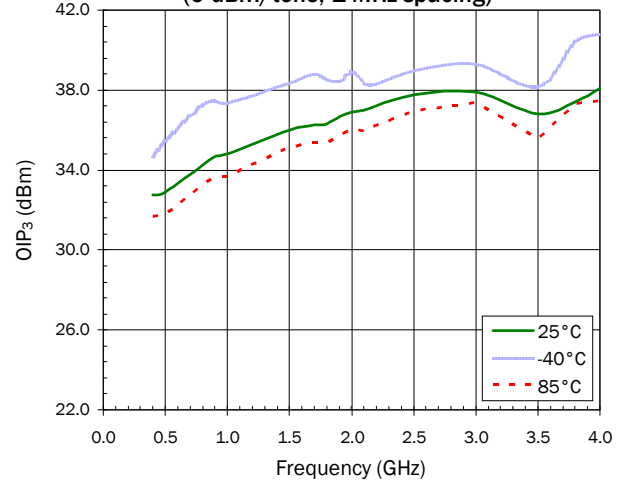

P_{1dB} versus Frequency

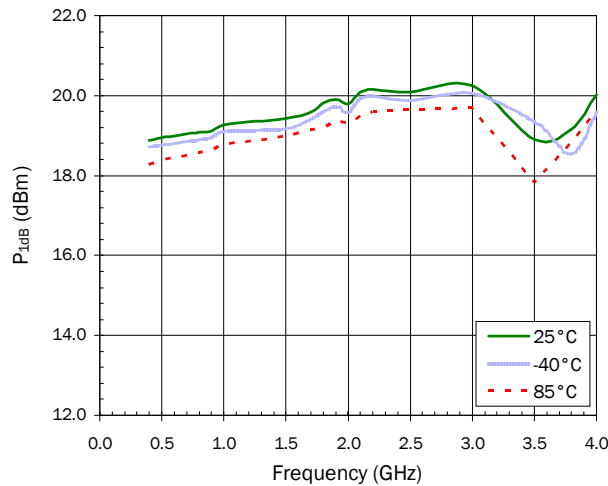

Typical RF Performance - Broadband Application Circuit with $V_D=3V$, $I_D=58mA$

S11 versus Frequency

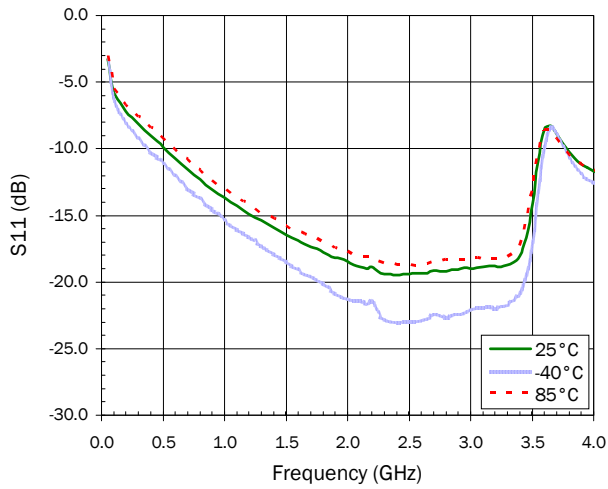

S21 versus Frequency

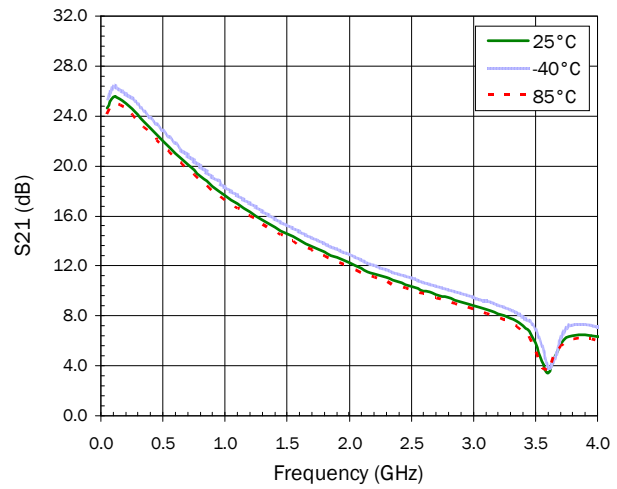

S12 versus Frequency

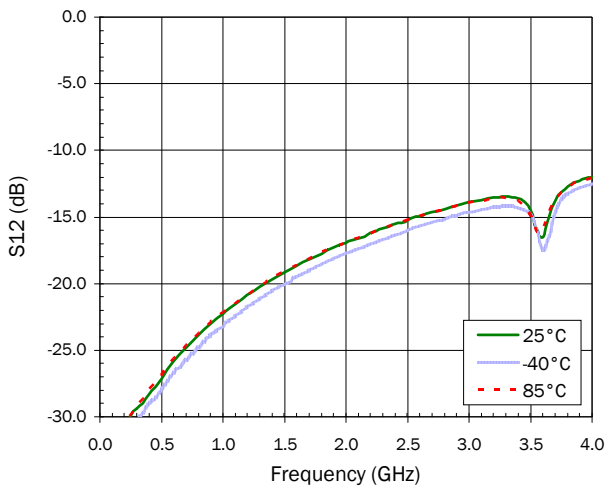

S22 versus Frequency

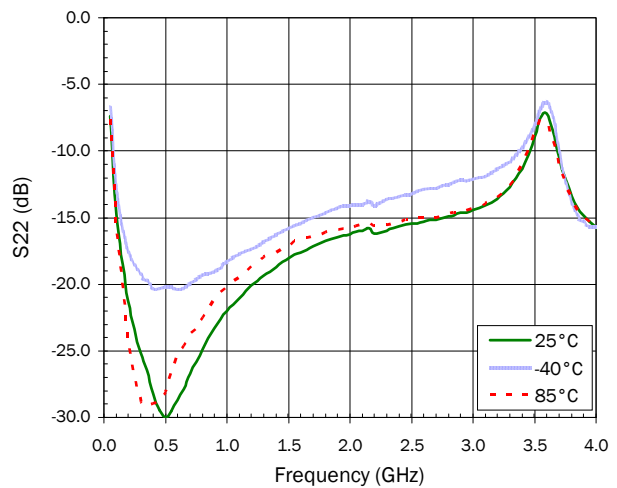

De-embedded Device S-parameters (Bias Tee Data)

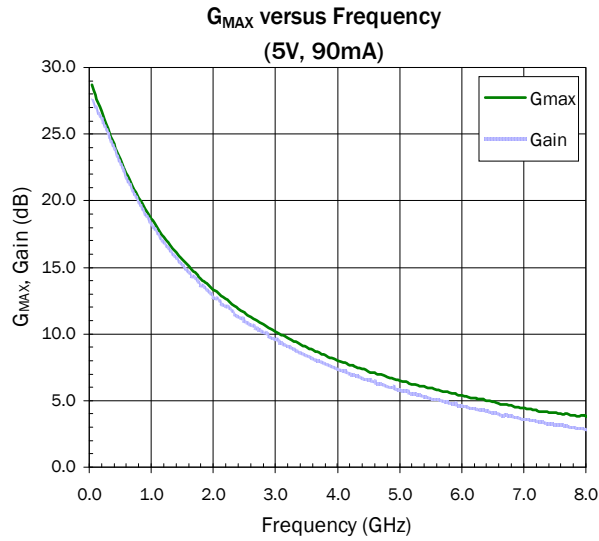

S11 versus Frequency (5V 90mA)

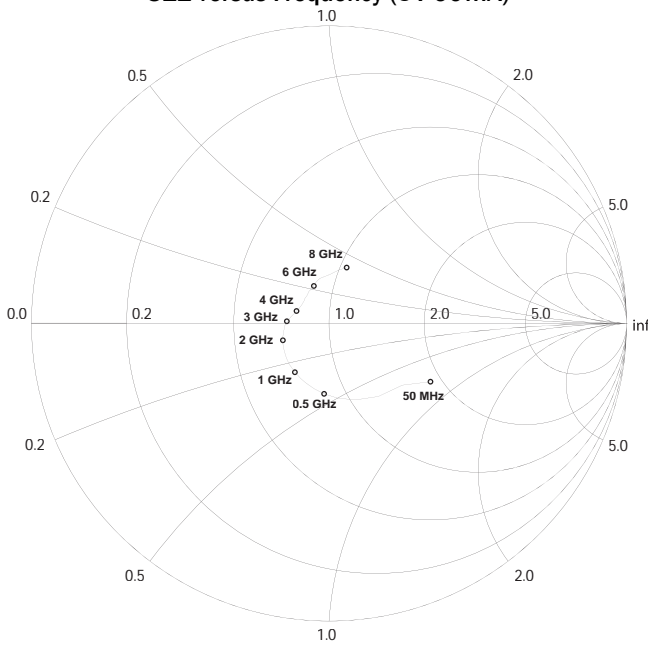

S22 versus Frequency (5V 90mA)

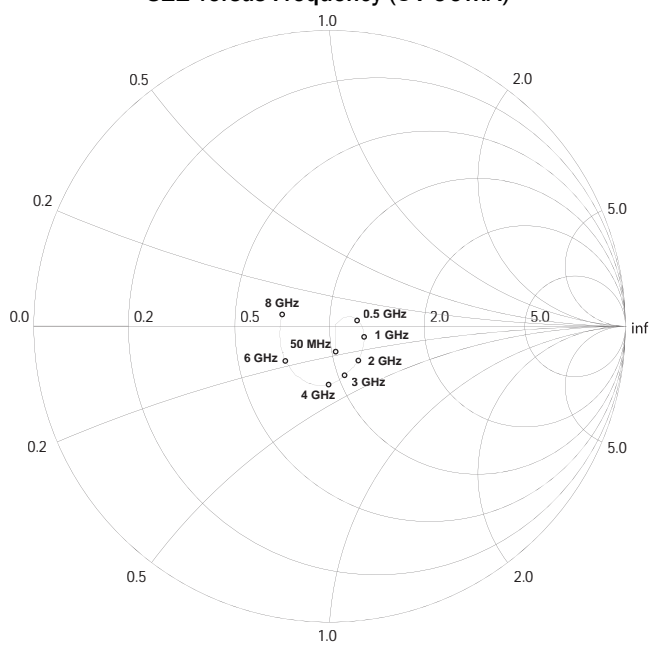

De-embedded Device S-Parameters (Bias Tee Data)

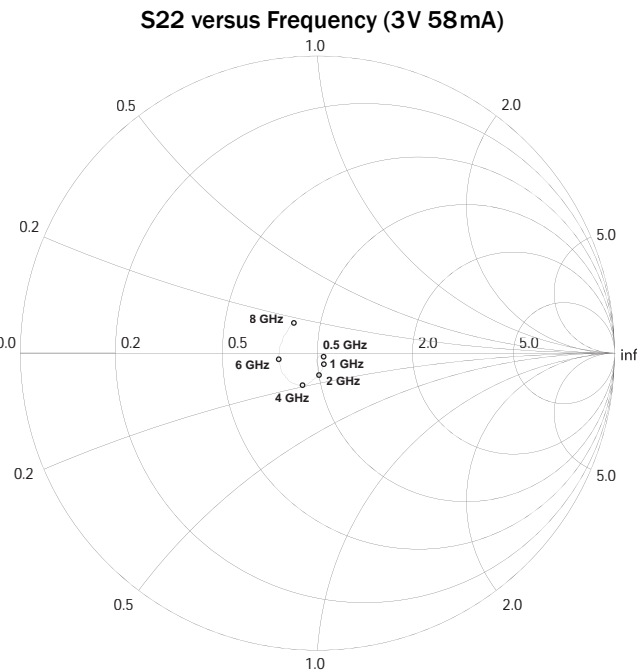
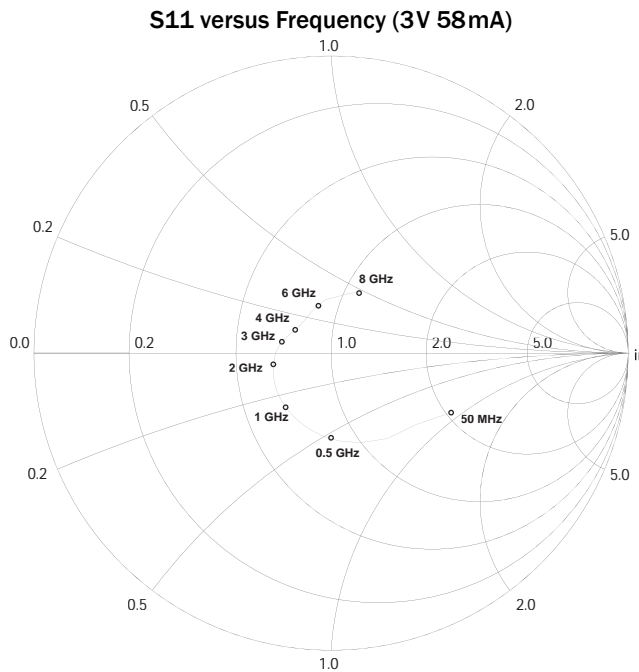
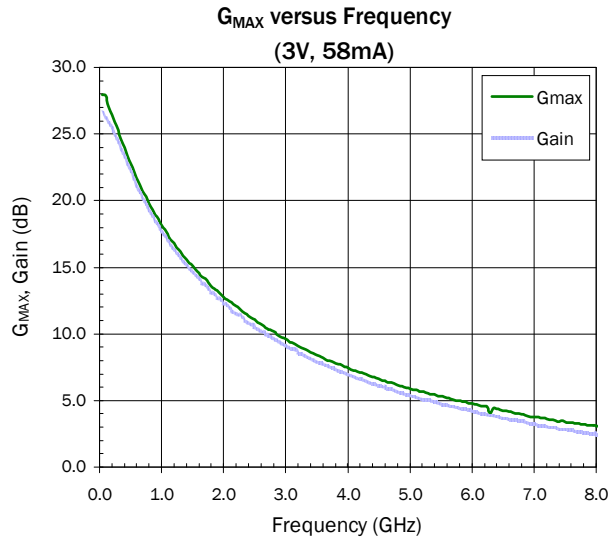

Evaluation Board Assembly Drawing

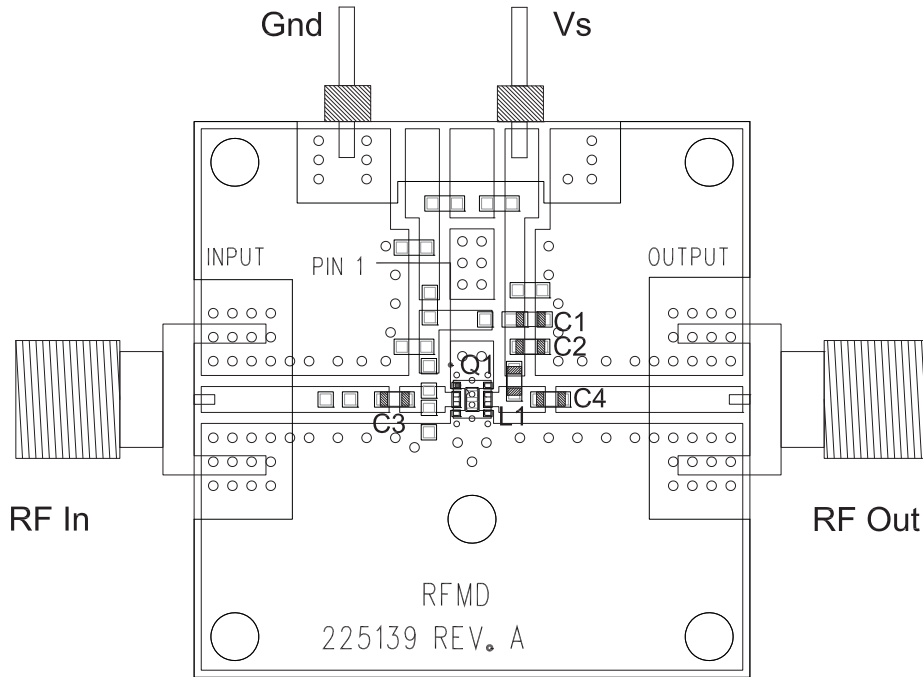

Evaluation Board Bill of Materials (BOM)

(400MHz to 3000MHz)

C1	AJB104KLRH, Rohm, 0.1uF
C2	MCH185A101JK, Rohm, 100pF
C3	MCH185A101JK, Rohm, 100pF
C4	MCH185A101JK, Rohm, 100pF
L1	LL1608-FSR15J, Toko, 150nH

Application Schematic

(400MHz to 3000MHz)

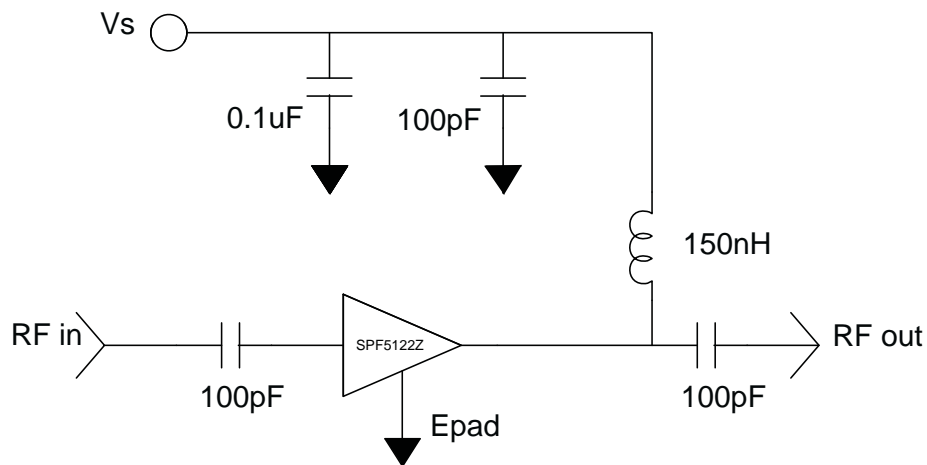

Pin Names and Description

Pin	Function	Description
1	N/A	Ground or No-Connect. No Connection Internal
2	RF IN	RF Input, DC Coupled and Matched to 50Ω. An External DC Block is Required.
3	N/A	Ground or No-Connect. No Connection Internal
4	N/A	Ground or No-Connect. No Connection Internal
5	N/A	Ground or No-Connect. No Connection Internal
6	N/A	Ground or No-Connect. No Connection Internal
7	RF OUT/BIAS	RF Output, Bias Applied Through This Pin. Matched to 50Ω.
8	N/A	Ground or No-Connect. No Connection Internal
EPAD	GND	EPAD Must be Conductively Attached to RF and DC Ground.

Part Identification

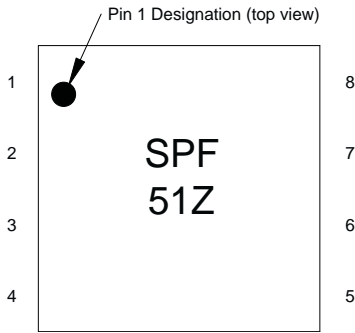

Suggested Pad Layout (Dimensions in inches)

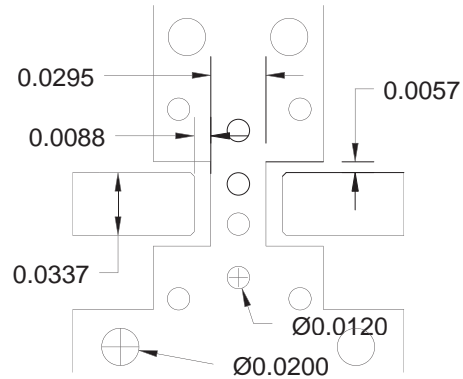

Package Drawing

Dimensions in millimeters

Refer to drawing posted at www.rfmd.com for tolerances.

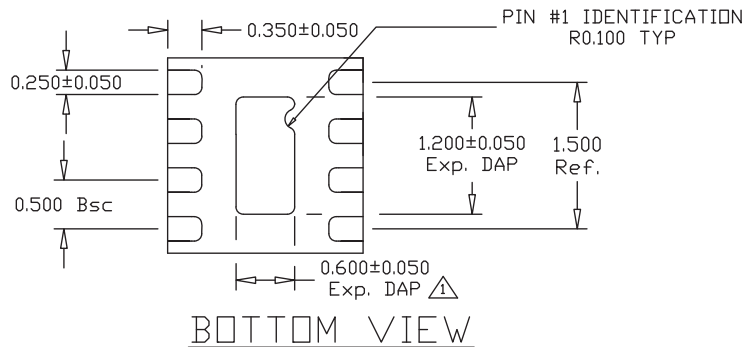
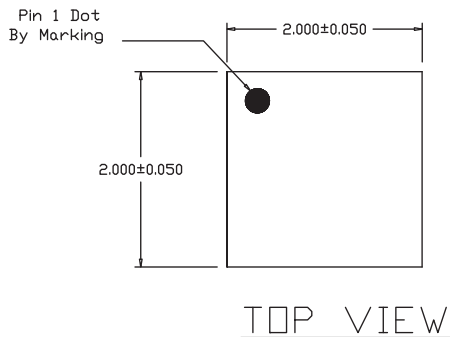

- Notes:
1. LF Base Metal - Qlin 194
 2. Exterior Plating
Basic PN - Sn/Pb 85/15
Z Option - 100% Matte Sn
 3. Flammability Rating
94V0
 4. Marking
Laser or White Phenolic Ink.

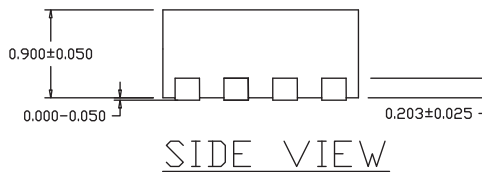

Ordering Information

Part Number	Description
SPF5122Z	7" Reel with 3000 pieces
SPF5122ZSQ	Sample Bag with 25 pieces
SPF5122ZSR	7" Reel with 100 pieces
SPF5122ZPCK1	400MHz to 3000MHz PCBA with 5-piece Sample Bag