

REVISIONS

P	LTR	DESCRIPTION	DATE	DWN	APVD
A		NEW RELEASE PER ECO-14-013595	09-05-14	DM	DM



Backshell

Compression Nut

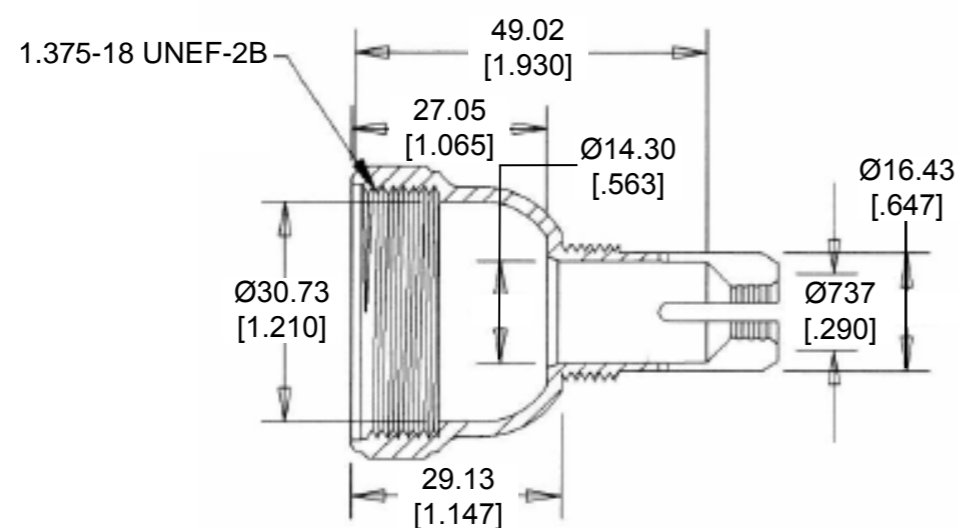
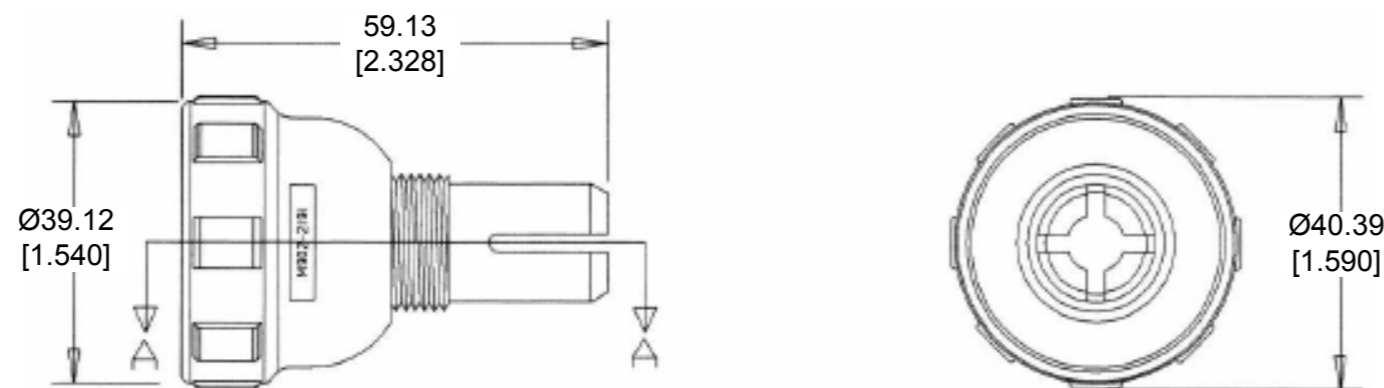

SECTION A-A

- 6. PART NO. M902-2191
- 5. CABLE STRIPPED LENGTH: 63.50 [2.500] MAX.
- 4. CABLE SIZE: Ø.187 - Ø.300
- 3. TEMPERATURE RATING: -40°C TO +134°C [-40°F TO +273°F]
- 2. THIS PART IS USED WITH:
COMPRESSION NUT, M902-2041
- 1. THIS PART IS USED ON
HD1X-9-96X PLUG / RECEPTACLES
HD1X-9-1939X PLUG / RECEPTACLES
SEE INDIVIDUAL CUSTOMER DRAWINGS

THIS DRAWING IS A CONTROLLED DOCUMENT.		DWN D. MEYER 05SEP2014			
DIMENSIONS: MM [INCH]		CHK I. GRANTCHAROVA 05SEP2014			
TOLERANCES UNLESS OTHERWISE SPECIFIED:		APVD D. MEYER 05SEP2014		NAME BACKSHELL, SIZE 9 CABLE SIZE: Ø.187 - Ø.300 HD10 SERIES	
		PRODUCT SPEC		SIZE A3	
MATERIAL PC/PBT		APPLICATION SPEC		CAGE CODE 4AFU8	
FINISH BLACK		WEIGHT 15.15 g		DRAWING NO. M902-2191	
		Customer Drawing		RESTRICTED TO -	
		SCALE NONE		SHEET 1 OF 1	
				REV A	