

1M1-Series
Miniature Rocker &
Paddle Switch



1MS-Series
Sealed Miniature
Rocker & Paddle
Switch

Specifications

Contact Rating	refer to ordering scheme.
Electrical Life	1M1-Series: 50,000 make & break cycles @ full load 1MS-Series: 30,000 make & break cycles @ full load
Contact Resistance.	10 mΩ max. initial @ 2-4 VDC 100mA for both silver & gold plated contacts.
Insulation Resistance	1000 MΩ min.
Dielectric Strength	1500 Volts RMS @ sea level
Operating Temperature . . .	-30°C to +85°C
Index of Protection	1MS-Series: IP67
Solder Heat Resistance. . .	MIL-STD-202, Method 210
Actuator Travel	25°

Materials

Case	1M1-Series: Dially phthalate (DAP) (UL 94V-0) 1MS-Series: Glass filled nylon 6/6, flame retardant, heat stabilized (UL 94V-0)
Rocker/Paddle.	1M1-Series: Nylon (UL 94V-0) 1MS-Series: Nylon, black standard, internal o-ring sealed
Bushing	1M1-Series: Brass, nickel plated 1MS-Series: Glass filled nylon 6/6, flame retardant, heat stabilized (UL 94V-0)
Housing.	1M1-Series: Stainless Steel 1MS-Series: Spring Steel
Actuator Pivot & Mounting Bracket	1M1-Series: Stainless Steel 1MS-Series: Nylon (UL 94V-0)
Actuator Pivot Retainer . . .	1MS-Series: Stainless Steel
Switch Support	Brass, tin plated
Terminal Seal	Epoxy

1M1-Series Ordering Scheme



1 SERIES
1M1 Miniature Rocker Switch

2 POLES
SP single pole - uses terminals 1, 2 & 3.
DP double pole uses terminals 1,2, 3, 4, 5 & 6.
3P double pole uses terminals 1,2, 3, 4, 5, 6, 7, 8 & 9.
4P double pole uses terminals 1,2, 3, 4, 5, 6, 7, 8, 9, 10, 11, 12.

3 CIRCUIT
 () - momentary

Switching Position:
 2-3, 5-6, 8-9, 11-12 OPEN 2-1, 5-4, 8-7, 11-10

1	ON	NONE	ON
2	ON	NONE	(ON)
3	ON	OFF	ON
4	(ON)	OFF	(ON)
5	ON	OFF	(ON)

4 ACTUATOR STYLE

R1	Small rocker	R5	Large rocker
R2	Small paddle	R6	Rocker & frame
R3	Medium rocker	R7	Paddle & frame
R4	Large paddle	R8	Rocker w/out frame
		R9	Paddle w/out frame

5 ACTUATOR COLOR & 6 FRAME COLOR^{1,2}

1 white	4 orange	7 blue
2 black	5 yellow	8 brown
3 red	6 green	9 gray

1 Black is standard. Other colors available, consult factory for details.
 2 Selection 6 is blank if actuator style R8 or R9 (no frame)

7 TERMINATION

M1	Solder Lug	VS4	PC Mount, U bracket, .460 high
M2	PCB	VS5	PC Mount, U bracket, .630 high
M3	Quick Connect	M61	Snap-In, U bracket, 90° horizontal
M5-1	Wire Wrap .750 [19.05]	M71	Snap-In, U bracket, 90° vertical
M5-2	Wire Wrap .964 [24.48]	VS21	Snap-In, U bracket, .620 mounting x .460 high
M5-3	Wire Wrap .425 [10.80]	VS31	Snap-In, U bracket, .620 mounting x .630 high
M5-4	Wire Wrap 1.062 [26.97]	VS41	Snap-In, U bracket
M6	PC Mount, 90° horizontal	VS51	Snap-In, U bracket
M7	PC Mount, 90° vertical		
VS2	PC Mount, U bracket, .620 mounting x .460 high		
VS3	PC Mount, U bracket, .620 mounting x .630 high		

8 CONTACT

G	Material	Terminal Plating	Rating	Approvals
	silver ¹	gold over silver ²	5A@125VAC or 28VDC, 2A @ 250VAC	UL CSA
K	gold ²	tin-lead ⁴	0.4VA max. @20V max (AC/DC)	-
P	silver ¹	tin-lead ⁴	5A@125VAC or 28VDC, 2A @ 250VAC	UL CSA
Q	silver ¹	silver ¹	5A@125VAC or 28VDC, 2A @ 250VAC	UL CSA
R	gold ²	gold ²	0.4VA max. @20V max (AC/DC)	-

NOTE:
 Tin-lead option available with PC type terminations only.
 1 Moveable contact & terminals: copper alloy, silver plate
 2 Moveable contact & terminals: copper alloy with gold plate over nickel plate
 3 Terminals: silver plate with outer layer in gold plating
 4 Outer terminals: copper alloy with tin-lead over nickel plate

9 EPOXY SEAL
E epoxy seal

1MS-Series Ordering Scheme



1 SERIES
1MS Sealed Miniature Rocker Switch

2 POLES
SP single pole - uses terminals 1, 2 & 3.
DP double pole uses terminals 1,2, 3, 4, 5 & 6.
3P double pole uses terminals 1,2, 3, 4, 5, 6, 7, 8 & 9.

3 CIRCUIT
 () - momentary

Switching Position:
 2-3, 5-6, 8-9 OPEN 2-1, 5-4, 8-7

1	ON	NONE	ON
2	ON	NONE	(ON)
3	ON	OFF	ON
4	(ON)	OFF	(ON)
5	ON	OFF	(ON)

4 ACTUATOR STYLE

R1	Small rocker	R5	Large rocker
R2	Small paddle	R6	Rocker & frame
R3	Medium rocker	R7	Paddle & frame
R4	Large paddle	R8	Rocker w/out frame
		R9	Paddle w/out frame

5 TERMINATION

M1	Solder Lug	VS3	PC Mount, U bracket, .620 mounting x .630 high
M2	PCB	VS4	PC Mount, U bracket, .460 high
M3	Quick Connect	VS5	PC Mount, U bracket, .630 high
M5-1	Wire Wrap .750 [19.05]	VS21	Snap-In, U bracket, .620 mounting x .460 high
M5-2	Wire Wrap .964 [24.48]	VS31	Snap-In, U bracket, .620 mounting x .630 high
M5-3	Wire Wrap .425 [10.80]	VS41	Snap-In, U bracket
M5-4	Wire Wrap 1.062 [26.97]	VS51	Snap-In, U bracket
M6	PC Mount, 90° horizontal		
M7	PC Mount, 90° vertical		
VS2	PC Mount, U bracket, .620 mounting x .460 high		

6 CONTACT

G	Material	Terminal Plating	Rating	Approvals
	silver ¹	gold over silver ²	5A@125VAC or 28VDC, 2A @ 250VAC	UL CUL
K	gold ²	tin-lead ⁴	0.4VA max. @20V max (AC/DC)	-
P	silver ¹	tin-lead ⁴	5A@125VAC or 28VDC, 2A @ 250VAC	UL CUL
R	gold ²	gold ²	0.4VA max. @20V max (AC/DC)	-

NOTE:
 Tin-lead option available with PC type terminations only.
 1 Moveable contact & terminals: copper alloy, silver plate
 2 Moveable contact & terminals: copper alloy with gold plate over nickel plate
 3 Terminals: silver plate with outer layer in gold plating
 4 Outer terminals: copper alloy with tin-lead over nickel plate

7 EPOXY SEAL
E epoxy seal

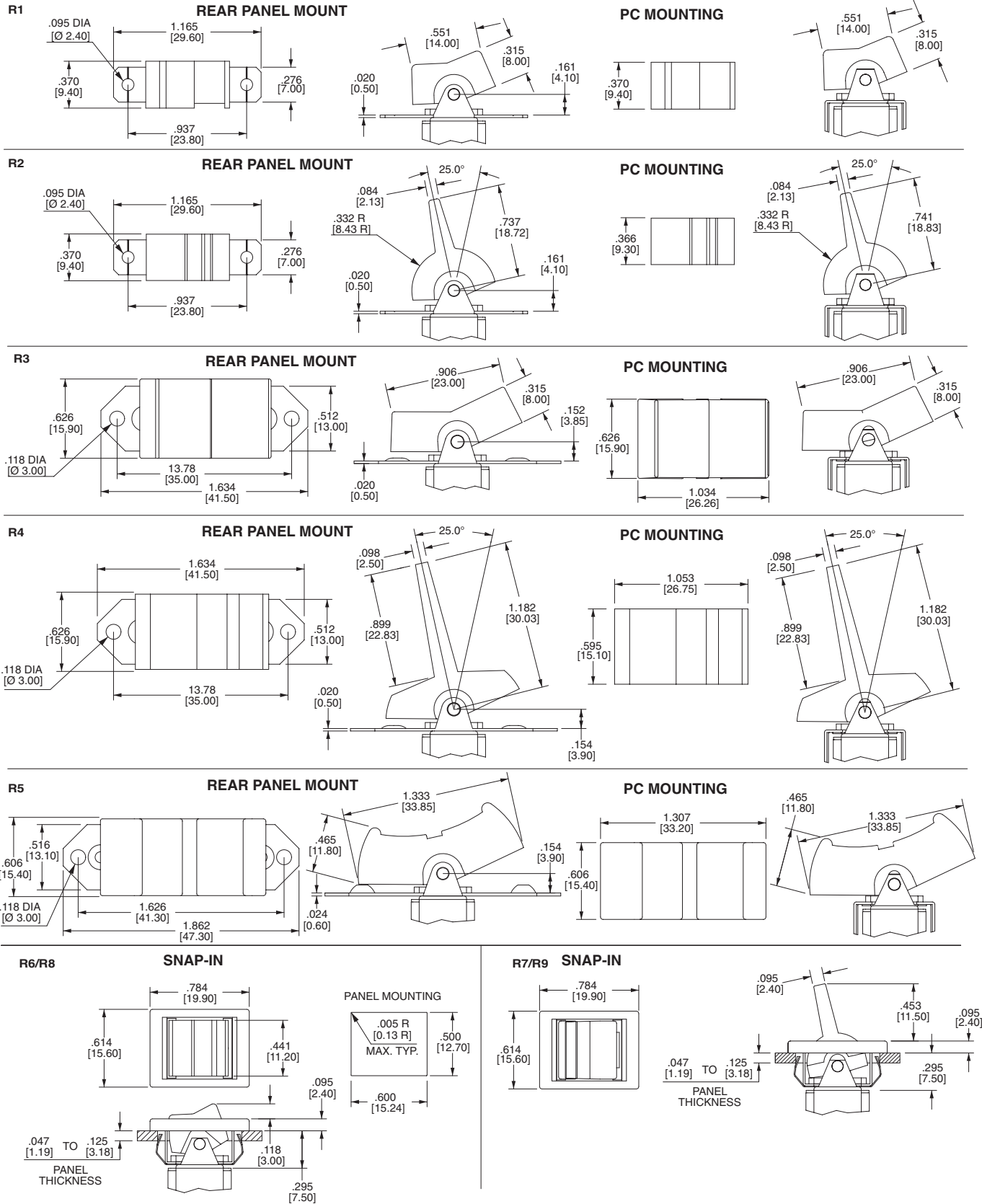
1M1-Series Dimensional Specifications: in.[mm]
ACTUATOR

R8 and R9 are without frame. Actuators are as shown.

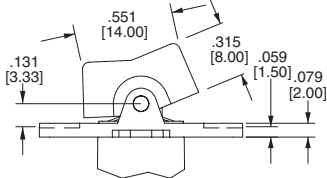
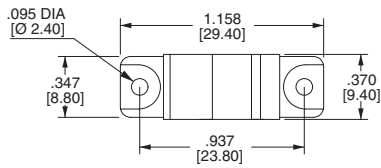
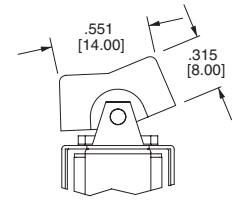
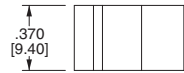
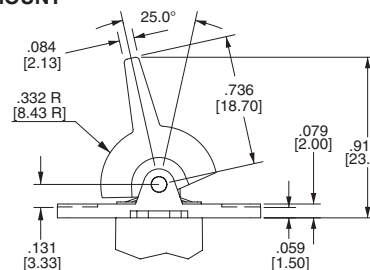
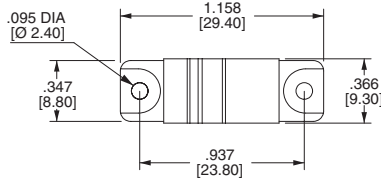
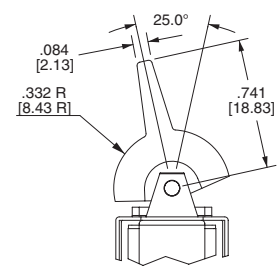
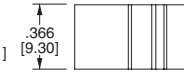
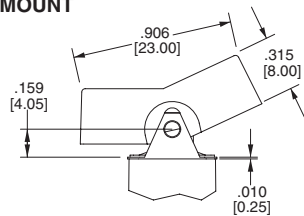
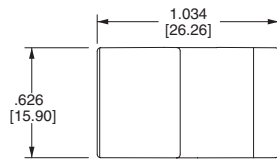
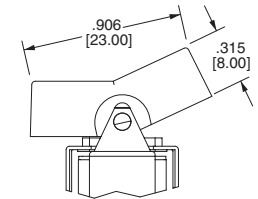
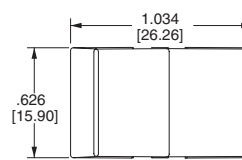
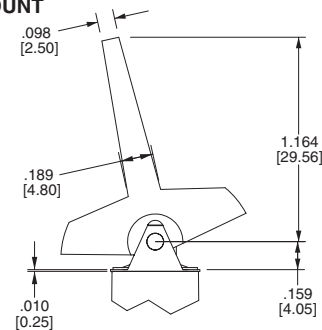
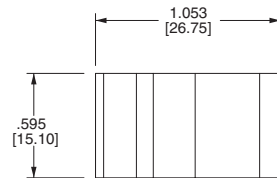
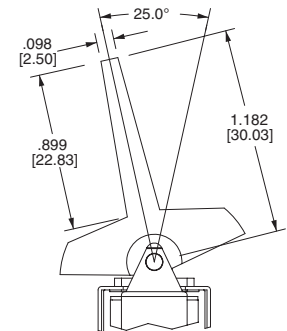
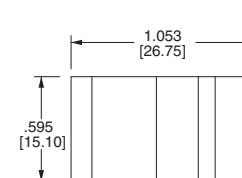
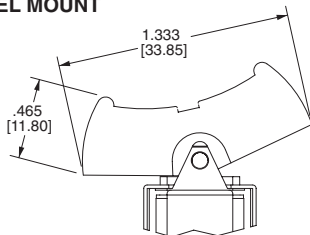
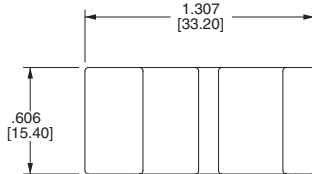
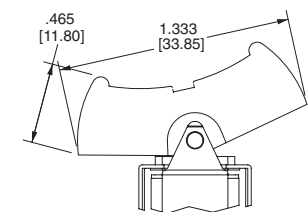
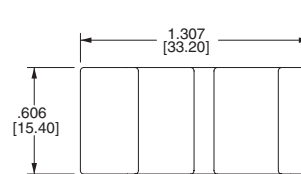
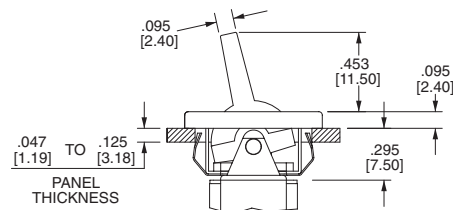
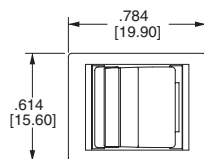
1MS-Series Dimensional Specifications: in.[mm]
ACTUATOR
R1 REAR PANEL MOUNT

PC MOUNTING

R2 REAR PANEL MOUNT

PC MOUNTING

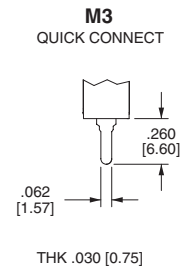
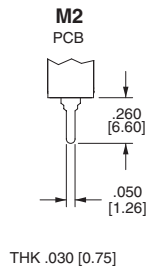
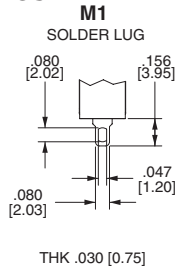
R3 REAR PANEL MOUNT

PC MOUNTING

R4 REAR PANEL MOUNT

PC MOUNTING

R5 REAR PANEL MOUNT

PC MOUNTING

R7 SNAP-IN

1M-Series Dimensional Specifications: in.[mm]

TERMINATION

1M1-Series



1MS-Series

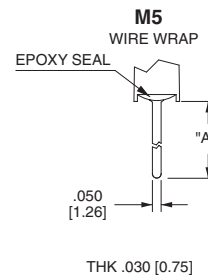
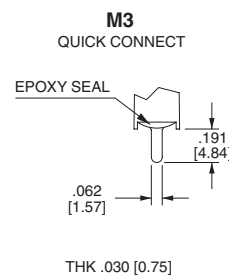
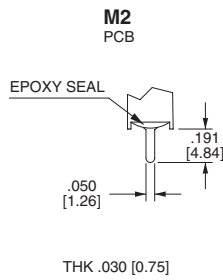
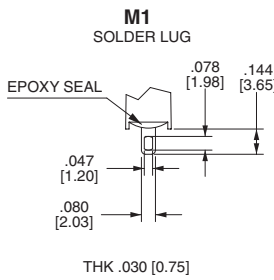

OPTION CODE	DIM. "A"
M5-1	.750 [19.05]
M5-2	.964 [24.48]
M5-3	.425 [10.80]
M5-4	1.062 [26.97]

1M-Series

M6

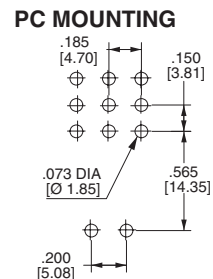
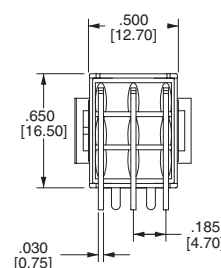
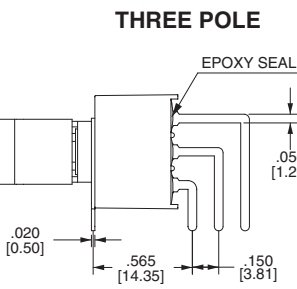
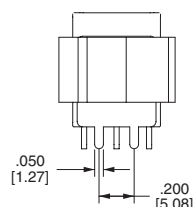
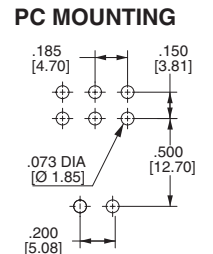
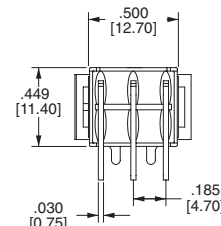
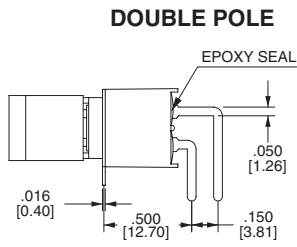
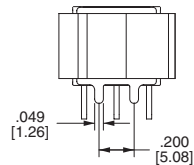
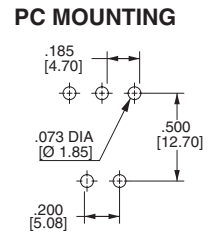
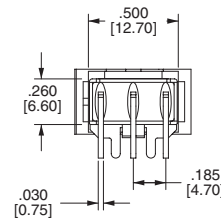
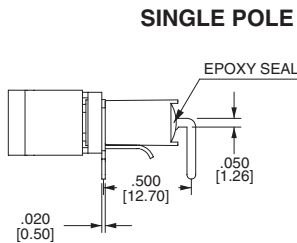
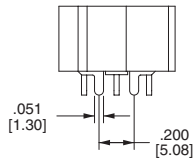

1M-Series Dimensional Specifications: in.[mm]

TERMINATION

