

Applications

- Splits SDARS & GPS Signals
- Automotive

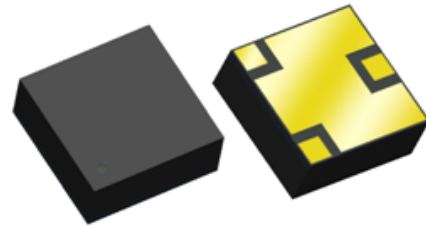

3 Pin 3 x 3 mm Leadless LGA Package

Product Features

- GPS/ SDARS Diplexer
- Size : 3.0 X 3.0 X 1.2 mm
- Laminate Based Over-Molded Module
- No external matching required for 50 Ω operation

Functional Block Diagram

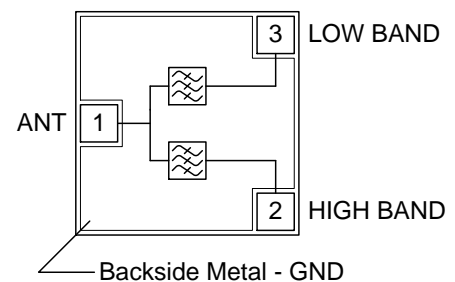

Top View

General Description

The TQM2M9016 splits SDARS and GPS signals from a single automotive antenna. This diplexer is housed in a 3.0 x 3.0 x 1.2 mm laminate based over-molded module.

The TQM2M9016 provides excellent insertion loss for both the GPS and SDARS signals while effectively protecting each band from the other. This diplexer is designed to match natively to 50 Ω . No external matching is required.

Pin Configuration

Pin #	Label
1	ANT
2	HIGH BAND
3	LOW BAND
Backside Metal	GND

Ordering Information

Part No.	Description
TQM2M9016	GPS/ SDARS Diplexer
TQM2M9016-EVB	Evaluation Board

Standard T/R size = 2500 pieces on a 13" reel.

Absolute Maximum Ratings

Parameter	Rating
Storage Temperature	-40 to 150 °C
RF Input Power, CW, 50 Ω, T = 25 °C	+10 dBm

Operation of this device outside the parameter ranges given above may cause permanent damage.

Recommended Operating Conditions

Parameter	Min	Typ	Max	Units
Operating Temp. Range	-40		+100	°C

Electrical specifications are measured at specified test conditions. Specifications are not guaranteed over all recommended operating conditions.

Caution: Pin 2 and pin 4 have an internal DC blocking capacitor. Pin 6 does not contain an internal DC blocking capacitor. Do not apply DC voltage to pin 6 (low band port).

Electrical Specifications – Low Band (GPS)

Test conditions unless otherwise specified: Temp.=+25 °C, Network analyzer power level set to -25 dBm

Parameter	Conditions	Min	Typ	Max	Units
Frequency Range		1.574	1.575	1.577	GHz
Insertion Loss		-	0.6	0.9	dB
Return Loss		12	20	-	dB
Attenuation	2.320 - 2.345 GHz	20	40	-	dB
Impedance		-	50	-	Ω

Electrical Specifications – High Band (SDARS)

Test conditions unless otherwise specified: Temp.=+25 °C, Network analyzer power level set to -25 dBm

Parameter	Conditions	Min	Typ	Max	Units
Frequency Range		2.32	2.33	2.345	GHz
Insertion Loss		-	0.8	1.0	dB
Return Loss		12	20	-	dB
Attenuation	1.574 – 1.577 GHz	20	31	-	dB
Impedance		-	50	-	Ω

Device Characterization Data

Input Response

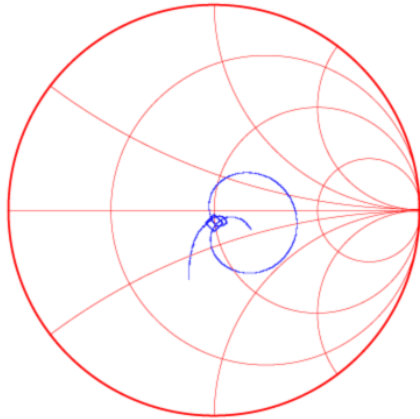

Low Band Response

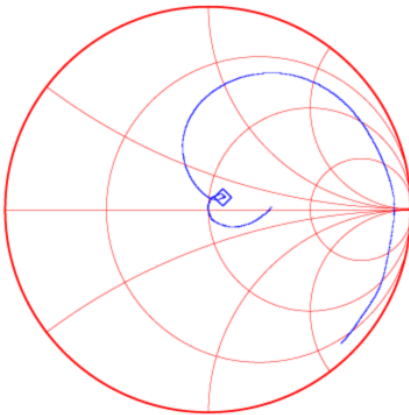

High Band Response

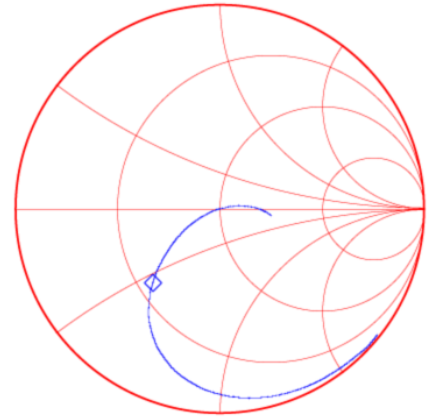

S-Parameter Data

Test Conditions: Temp. = 25 °C, Network analyzer power level set to -25 dBm

Freq (MHz)	S11 (dB)	S11 (ang)	S12 (dB)	S12 (ang)	S13 (dB)	S13 (ang)
1574	-24.02	-86.3	-0.58	-113.7	-43.99	-147.7
1578	-24.38	-87.3	-0.59	-114.3	-42.49	-143.3
2320	-19.41	-99.2	-33.67	-108.3	-0.79	124.6
2346	-20.11	-103.8	-30.50	-99.6	-0.76	121.2

Freq (MHz)	S21 (dB)	S21 (ang)	S22 (dB)	S22 (ang)	S23 (dB)	S23 (ang)
1574	-0.58	-113.7	-20.48	37.8	-36.42	41.4
1578	-0.58	-114.3	-20.69	39.5	-36.04	45.2
2320	-33.68	-108.5	-0.84	4.2	-31.14	-15.8
2346	-30.48	-99.6	-0.81	0.9	-29.21	-8.4

Freq (MHz)	S31 (dB)	S31 (ang)	S32 (dB)	S32 (ang)	S33 (dB)	S33 (ang)
1574	-44.06	-148.1	-36.43	41.1	-0.38	-67.2
1578	-42.50	-143.0	-36.08	44.9	-0.38	-67.6
2320	-0.79	124.6	-31.12	-15.9	-19.65	-151.5
2346	-0.74	121.2	-29.19	-8.5	-21.11	-155.9

TQM2M9016-EVB

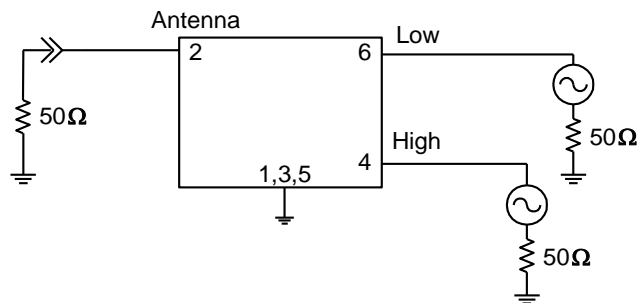
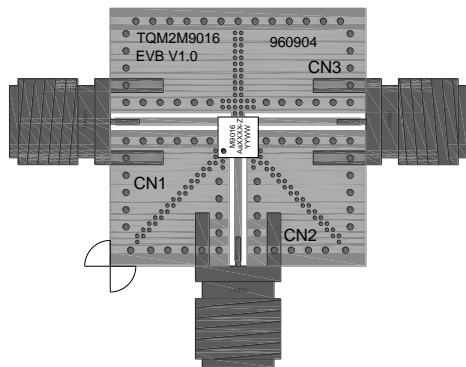

The board material is ½ oz Cu Top layer, .0075 Taconic TLY-5A dielectric, ½ oz Cu middle layer, FR4 dielectric, ½ oz Cu Bottom layer. Finished board thickness to be .062 +/- .004

Bill of Material – TQM2M9016-EVB

Reference Des.	Value	Description	Manuf.	Part Number
U1	n/a	GPS/SDARS Diplexer	TriQuint	TQM2M9016
CN1, CN2, CN3	n/a	SMA connector	Radiall USA Inc.	9602-1111-018

Typical Performance – Low Band 1574 – 1577 MHz (GPS)

Test conditions: Temp. = 25 °C, Network analyzer power level set to -25 dBm

Parameter	Typical Value				Units
Temperature	-40	+25	+85	+100	°C
Insertion Loss	0.51	0.58	0.67	0.68	dB
Return Loss	20	20.5	20.7	20.7	dB
High Band Attenuation (2.320 – 2.345 GHz)	45.5	43	40.7	40.3	dB

Typical Performance – High Band 2320 – 2345 MHz (SDARS)

Test conditions: Temp. = 25 °C, Network analyzer power level set to -25 dBm

Parameter	Typical Value				Units
Temperature	-40	+25	+85	+100	°C
Insertion Loss	0.7	0.78	0.87	0.89	dB
Return Loss	19.6	19.7	20	20	dB
Low Band Attenuation (1.574 – 1.577 GHz)	31.5	30.5	29.7	29.7	dB

Typical Performance – TQM2M9016-EVB

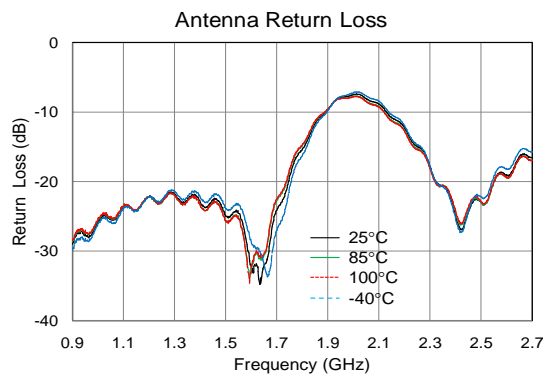
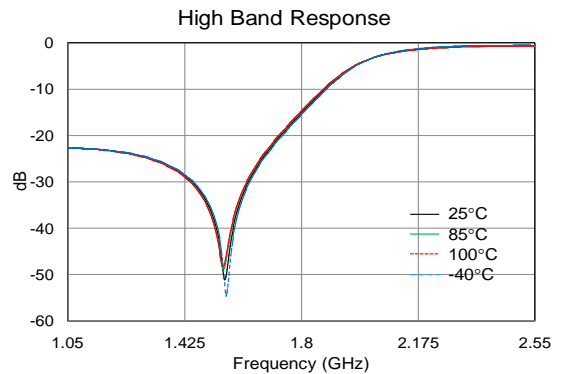
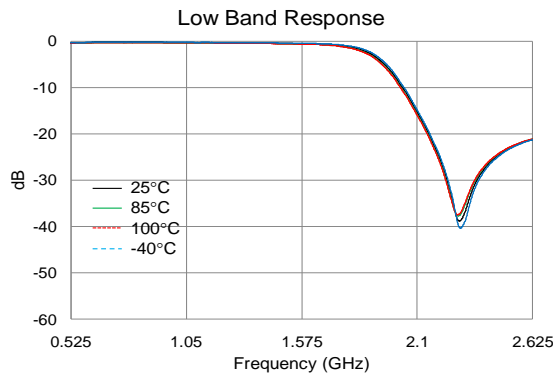
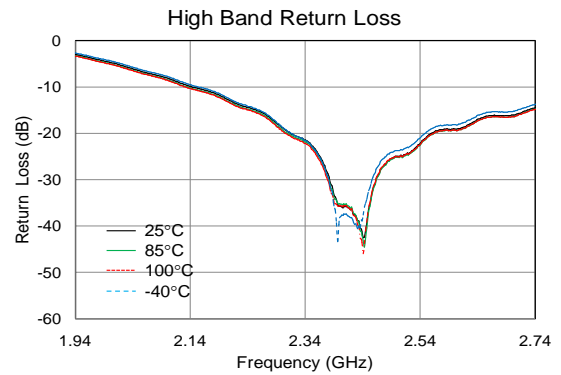
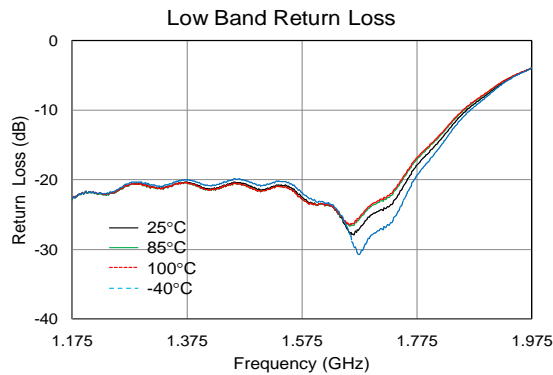
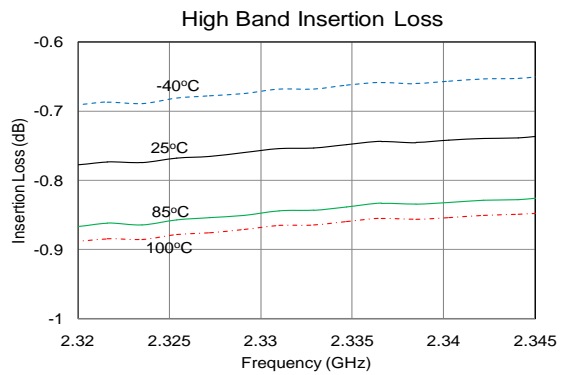
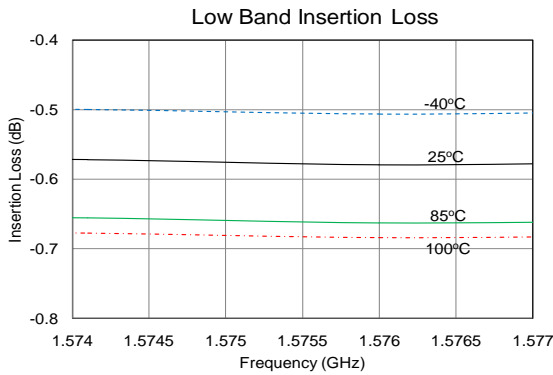

Package Marking and Dimensions

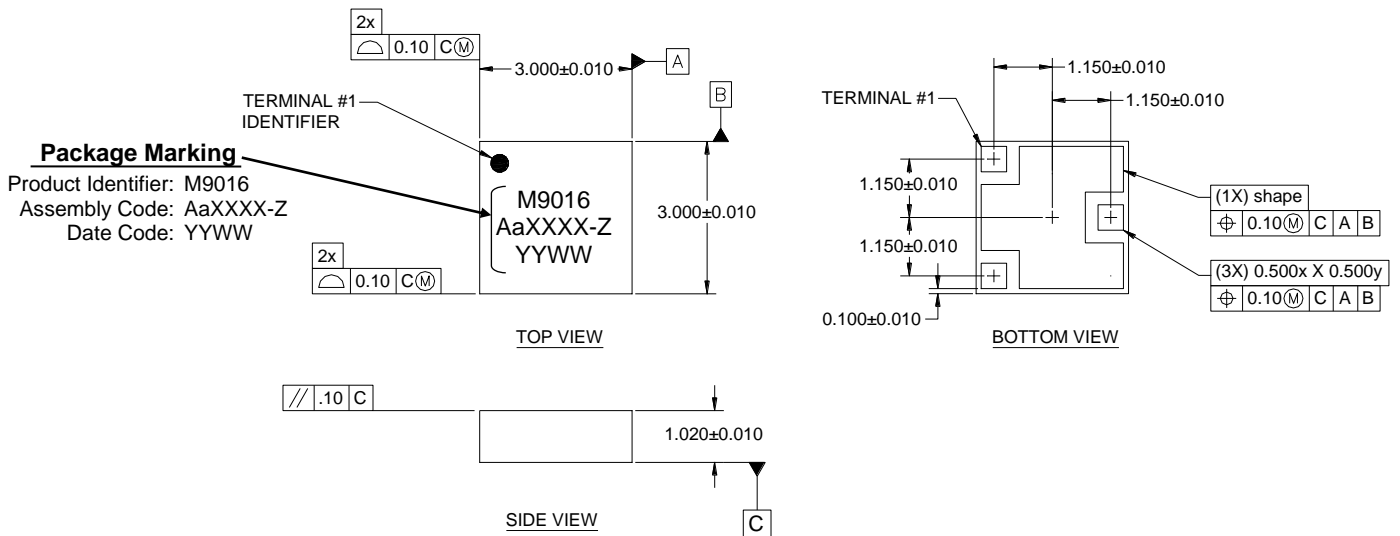

Notes:

1. All dimensions are in millimeters. Angles are in degrees.
2. Except where noted, this part outline conforms to JEDEC standard MO-270, Issue B (Variation DAE) for extra thin profile, fine pitch, internal stacking module (ISM).
3. Dimension and tolerance formats conform to ASME Y14.4M-1994.
4. The terminal #1 identifier and terminal numbering conform to JESD 95-1 SPP-012.

PCB Mounting Pattern

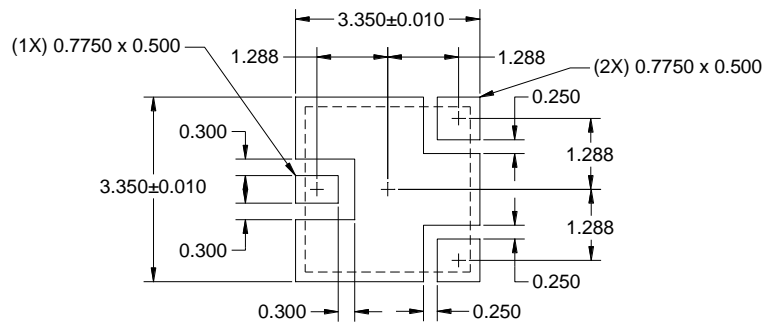

Notes:

1. All dimensions are in millimeters. Angles are in degrees.
2. Use 1 oz. copper minimum for top and bottom layer metal.
3. Ensure good package backside paddle solder attach for reliable operation and best electrical performance.

Product Compliance Information

ESD Sensitivity Ratings



Caution! ESD-Sensitive Device

ESD Rating: Class 3B

Value: ≥ 8000 V

Test: Human Body Model (HBM)

Standard: JEDEC Standard JS-001-2012

ESD Rating: Class C3

Value: ≥ 1000 V

Test: Charged Device Model (CDM)

Standard: JEDEC Standard JESD22-C101F

ESD Rating: Class C

Value: ≥ 400 V

Test: Machine Model (MM)

Standard: JEDEC Standard JESD22-A115

MSL Rating

MSL Rating: Level 3

Test: 260°C convection reflow

Standard: JEDEC Standard IPC/JEDEC J-STD-020

Solderability

Compatible with both lead-free (260 °C max. reflow temperature) and tin/lead (245 °C max. reflow temperature) soldering processes.

Package contact plating: Ni / Au

RoHS Compliance

This part is compliant with EU 2002/95/EC RoHS directive (Restrictions on the Use of Certain Hazardous Substances in Electrical and Electronic Equipment).

This product also has the following attributes:

- Lead Free
- Halogen Free (Chlorine, Bromine)
- Antimony Free
- TBBP-A (C₁₅H₁₂Br₄O₂) Free
- PFOS Free
- SVHC Free

Contact Information

For the latest specifications, additional product information, worldwide sales and distribution locations, and information about TriQuint:

Web: www.triquint.com

Email: info-sales@triquint.com

Tel: +1.407.886.8860

Fax: +1.407.886.7061

For technical questions and application information: **Email:** sjcappliations.engineering@triquint.com

Important Notice

The information contained herein is believed to be reliable. TriQuint makes no warranties regarding the information contained herein. TriQuint assumes no responsibility or liability whatsoever for any of the information contained herein. TriQuint assumes no responsibility or liability whatsoever for the use of the information contained herein. The information contained herein is provided "AS IS, WHERE IS" and with all faults, and the entire risk associated with such information is entirely with the user. All information contained herein is subject to change without notice. Customers should obtain and verify the latest relevant information before placing orders for TriQuint products. The information contained herein or any use of such information does not grant, explicitly or implicitly, to any party any patent rights, licenses, or any other intellectual property rights, whether with regard to such information itself or anything described by such information.

TriQuint products are not warranted or authorized for use as critical components in medical, life-saving, or life-sustaining applications, or other applications where a failure would reasonably be expected to cause severe personal injury or death.