

CUSTOMER'S NAME

ALPHA REFERENCE NO.

MOUSER ELECTRONICS



SP18100178

SPECIFICATION

PART NO.	ALPHA MODEL NAME
	RV142FPF-40B1-15K-0B10K-004

MODEL NAME
MODEL NO.

APPROVAL

PREPARED BY	REVIEWED BY	APPROVED BY
 2018.11.05 鄧彩霞	 2018.11.05 李延玲	 2018.11.05 章祖衛



台灣艾華電子工業股份有限公司

33045 桃園市桃園區中正路 1221 號 9 樓

TAIWAN ALPHA ELECTRONIC CO., LTD.

9F, No. 1221, Chung Cheng Rd., Taoyuan Dist., Taoyuan City, 330 Taiwan

Tel: 886-3-3577799 Fax: 886-3-3577700

EMAIL: sales@taiwanalpha.com.tw

URL: <http://www.taiwanalpha.com>

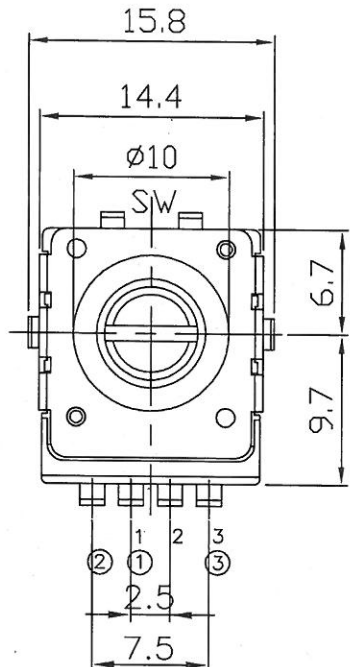
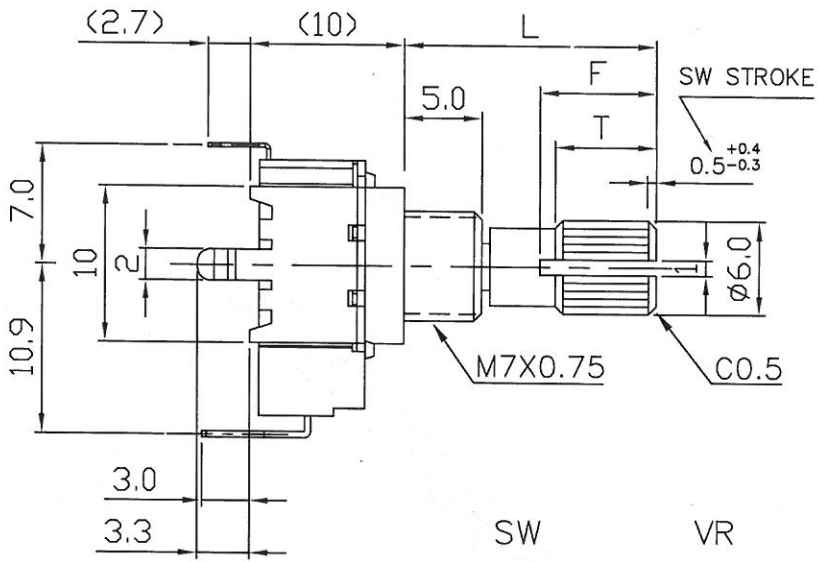

1 2 3 1-st layer
 ① ② ③ 2-nd layer

● 360° ROTATION
 DUAL UNIT WITH SWITCH
 SW PUSH SWITCH
 DC 12V 0.3A

NUT 1 PC

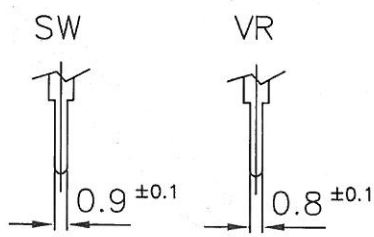

TERMINAL DETAIL

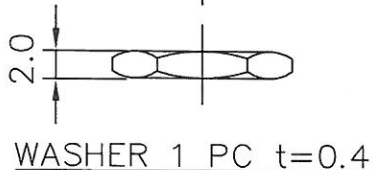
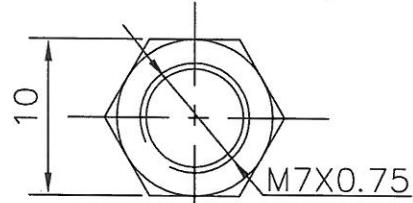

WASHER 1 PC t=0.4

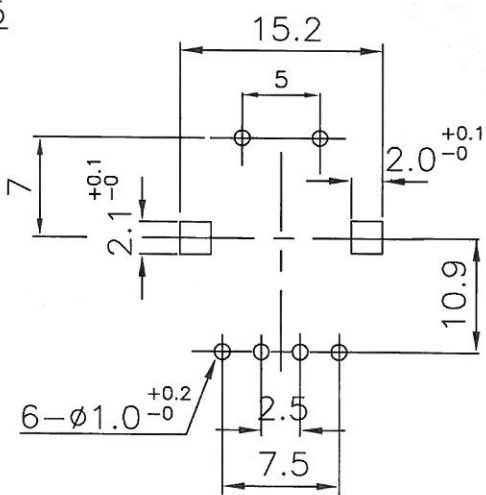
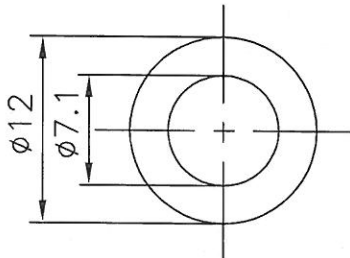

P.C.B. MOUNTING HOLE DETAIL

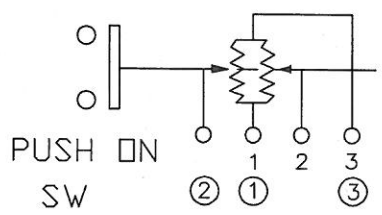

PUSH ON SW

	L	F	T
	15	7	6

							RV142FPF-40B1-(L)K-XXX(-004)	
No.	DATE	DESCRIPTION			MODEL NAME			
TOL.UNLESS OTHERWISE STATED		DIMENSION	SCALE	DRAWN BY	CHECKED BY	APPROVED BY	DRAWING No.	
less than	10	±0.3	mm	2/1	李 2018.11.5. 延玲	2018.11.05 祖衛		
above	10~30	±0.5						
above	30~100	±1.0						
above		±5'						

SPECIFICATIONS OF 11 Ø ROTARY POTENTIOMETER

一、 Environment

1.1 Operating temperature range: -10~+70°C

使用溫度範圍: -10~+70°C

1.2 Storage temperature range: -25~+75°C

儲存溫度範圍: -25~+75°C

1.3 Test conditions

試驗條件

Standard atmospheric conditions

標準狀態

Unless otherwise specified, the standard range of atmospheric Conditions for making measurements and tests is as follows:

無特別規定之實驗及測定時以溫度

Ambient temperature: 5~35°C Relative humidity : 45~85%

5~35°C, 相對溼度 45~85%, 氣

Air pressure: 860 mbar to 1060 mbar

壓 860~1060mbar 之標準狀態測定

If there is any doubt about the results, measurements shall be made within the following limit

發生判定疑問或另有特別要求則以

Ambient temperature: 20±2°C Relative humidity : 60~70%

基準狀態(溫度 20±2°C, 相對溼度

Air pressure: 860 mbar to 1060 mbar

60~70% 氣壓 860~1060mbar) 為準測定

二、 Mechanical characteristics 機械的性能

	Item 項目	Specifications 規格
1	Total rotational angle 全迴轉角度	360°
2	Rotational torque 迴轉轉矩	10~200gf-cm
3	Rotational speed 迴轉速度	Rotational speed 60° /1 sec.
4	Push and pull strength of shaft 軸壓拉強度	Push and pull static load of 6kgf shall be applied to the shaft in the axial direction for 3 seconds. No abnormality in electric characteristics and operating feeling. 在軸壓及拉的方向加 6kgf 靜負荷 3 秒鐘, 作用後不會影響其電氣特性及操作感覺。
5	Shaft wobble 軸晃動	A momentary load of 500gf-cm shall be applied at the point 5mm from the tip of the shaft in a direction perpendicular to the axis of shaft, the wobble is 0.7 x L / 30 mm p-p max. (L: shaft length). 軸端前 5 mm 位置加 500gf-cm, 晃動程度 0.7 x L / 30 mm p-p 以下, (L: 軸長)。

SPECIFICATIONS OF 11 Ø ROTARY POTENTIOMETER



	Item 項目	Specifications 規格
6	Resistance to soldering heat 銲錫耐熱性	After soldering without excessive looseness of terminals and failure contact 銲錫後，端子不能有顯著的接觸不良發生
7	Bushing nut tightening strength 軸套螺帽固定強度	7kgf-cm

三、Electrical characteristics 電氣的性能

	Item 項目	Specifications 規格
1	Nominal total resistance 全阻抗值許容公差	Terminal 1-3 10 KΩ±20 % 1-3 端全阻值 10 KΩ± 20 %
2	Rated wattage 額定功率	0.05W
3	Maximum working voltage 最大工作電壓	DC 5~15V 直流 5~15 伏
4	Insulation resistance 絕緣阻抗	100MΩ min at DC250 volts DC 250V 需在 100 MΩ 以上
5	Dielectric strength 耐電壓	Apply Ac 150V for 1 min, between individual switch terminals and case/shaft, without damage to parts, arcing or breakdown etc 在開關端子與本體和軸間施以 AC 150V 耐 1 分鐘以上，沒有損傷、變形、絕緣破壞等情形
6	V.R life 可變電阻壽命	15,000 cycles

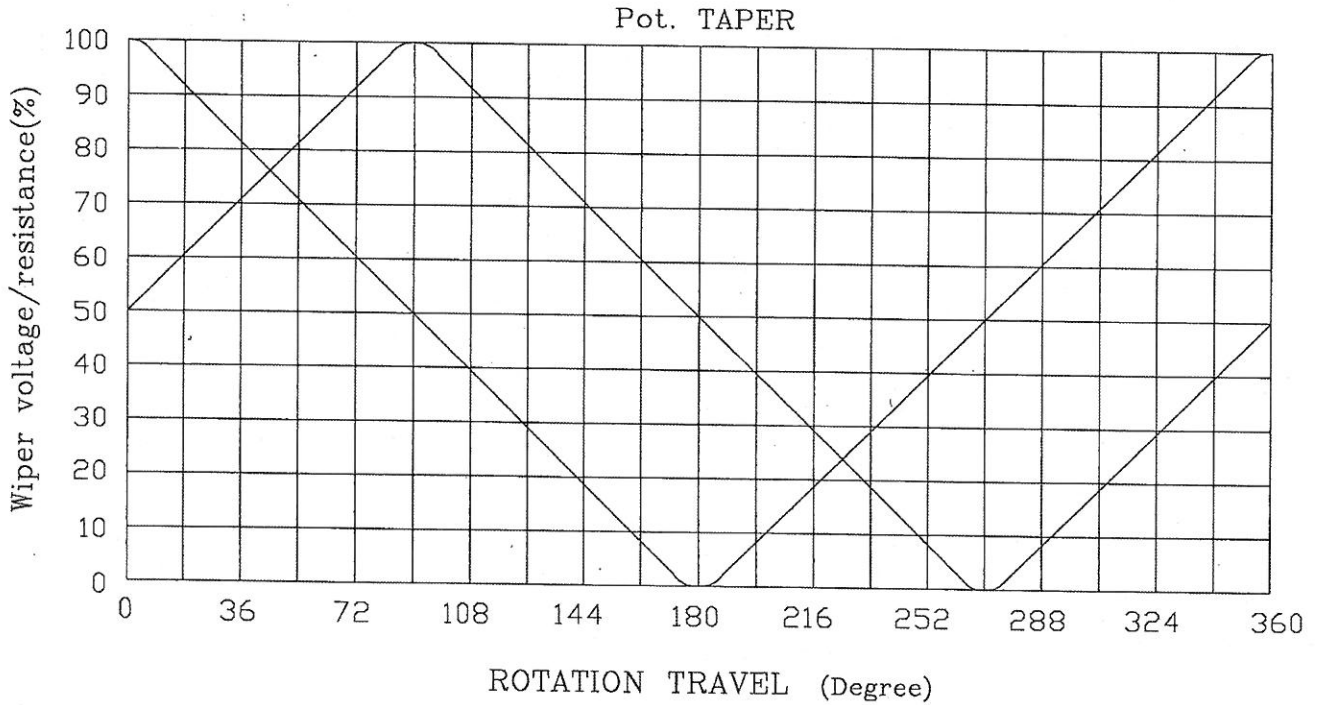
STANDARD RESISTANCE TAPER



				RV142FPF			
NO.	DATE	DESCRIPTION			MODEL NAME		
TOL. UNLESS OTHERWISE STATED		DIMENSION	SCALE	DRAWN BY	CHECKED BY	APPROVED BY	DRAWING NO.
less than	10	±0.3					
above	10 ~ 30	±0.5					
above	30 ~ 100	±1.0					
above		±5°					
		mm					

© TAIWAN ALPHA ELECTRONIC CO., LTD.

台灣艾華電子工業股份有限公司
TAIWAN ALPHA ELECTRONIC CO.,LTD.

Common Specification of Lead-Free Soldering and Storage conditions for Potentiometers

以下焊錫條件以可變電阻置於單層 1.6mm 厚度之印刷電路板上測試為基準。

The specification below is based on testing results of 1.6mm thickness single layer printed circuit board.

1. 手工焊錫條件：

For Manual Soldering：

1-1 操作溫度最高 350°C，操作時間 3 秒以內。

To be performed within 3 seconds at 350°C or below.

2. 自動或半自動機台焊錫條件：

For Automated or Semi-Automated Soldering Equipments:

2-1 使用發泡式且比重 0.82 以上的助焊劑，發泡高度以印刷電路板厚度一半為標準，且助劑不能流入可變電阻基板表面及印刷電路板表面。

Flux of 0.82 specific gravity, applied by foam fluxer, shall be used. Foam head shall be limited to the height which is half thickness of printed circuit board to be soldered. No flux should be allowed to run up onto resistive element board of potentiometer and the surface of printed circuit board.

2-2 預熱時間不超過兩分鐘，焊錫界面（即印刷電路板底）最高預熱溫度不超過 100°C。

Regarding preheating, the entire flow duration should not exceed 2 minutes, and soldering surface temperature (undersurface of PCB) shall be settled within 100°C.

2-3 焊錫過程機台設定溫度在 260°C 以下、4 秒以內。

Solder Dipping is to be performed within 4 seconds at 260°C or below.

3. 若回轉型電位器是塑膠軸且帶有檔位，請將主軸先調整至其中一個檔位或中心檔位上才可以進行焊錫作業。

For rotary potentiometer with plastic shaft which have centre detent or multiple detents, the shaft should be settled in relevant detent position prior to soldering process.

4. 手工焊錫、自動或半自動機台焊錫不得超過一回。

Regardless of soldering facility and method, solder dipping or solder smearing must not be carried out more than 1 time.

註：本項焊錫溫度條件不適用於回流焊接作業設備。

Remarks: This specification is not recommended for and applicable in reflow soldering.

焊錫注意事項：

Caution for soldering:

如圖所示，請避免 PCB 上層表面有焊錫

Please avoid soldering on upper surface of P.C.B. as shown.

5. 保管條件(Storage conditions):

產品需儲存在原始的包裝,以及保持常溫

常濕、避免陽光直射、遠離任何腐蝕性氣體.

產品需盡快完全地使用完,建議最慢不要超過

交貨後 6 個月. 產品經拆封後, 全部的數量都需迅速地使用完.

The products shall be stored in the original packaging and kept at room temperature and humidity, out of direct sunlight, and away from any and all corrosive gas. The products shall be completely used as soon as possible, but no longer than 6 months from the date of delivery. Once product packaging is opened, the complete quantity of such products shall be promptly used.

