

## ACT2861EVK1-201 Rev B User's Guide

### Description

This document describes the characteristics and operation of the Active Semi ACT2861EVK1-201 evaluation kit (EVK). It provides setup and operation instructions, schematic, layout, BOM, and test data. This EVK demonstrates the ACT2861QI201 CMI version of the IC. Other ACT2861Qlxxx options can be evaluated on this EVK by replacing the IC and any other necessary components.

### Features

The EVK can be used as a standalone board if desired. However, to access the internal registers and to take full advantage of the IC's capability, the user must connect the EVK kit to a PC with Active Semi's USB-TO-I<sup>2</sup>C interface dongle and use the GUI software. The EVK provides full access to each converter's input and output voltage, as well as all the digital control signals. This gives the user the flexibility to configure the EVK to match their real world system.

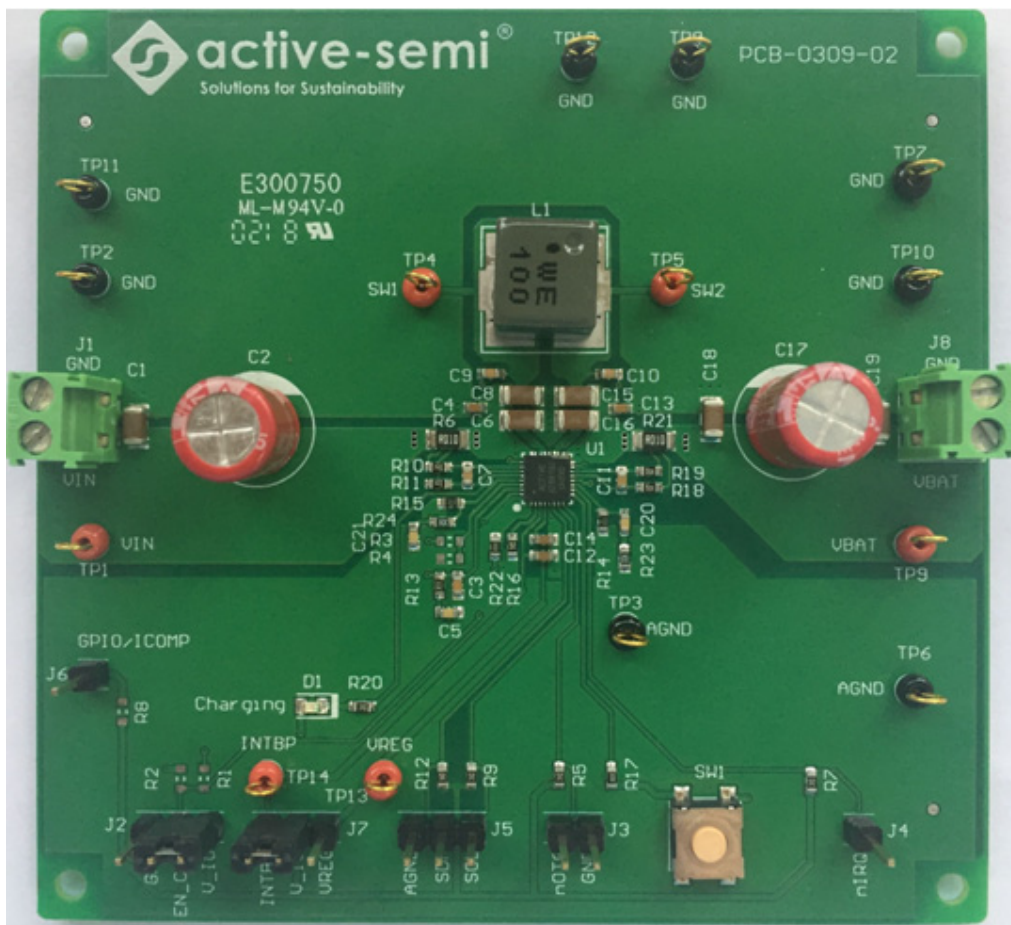

Figure 1 – EVK Picture

## EVK Contents

The ACT2861EVK1-201 evaluation kit comes with the following items:

1. EVK assembly
2. USB-TO-I2C dongle
  - a. Dongle
  - b. Custom 4-pin connector that connects the USB-TO-I2C dongle to the EVK assembly

## Required Equipment

ACT2861EVK1-201

USB-TO-I2C Dongle

Power supply →4~30V @ 6A for full power operation

Oscilloscope →100MHz, 4 channels

2-Serial Li-battery (or power supply capable of acting like a battery)

Digital Multi-meters (DMM)

Windows compatible PC with spare USB port.

## Hardware Setup

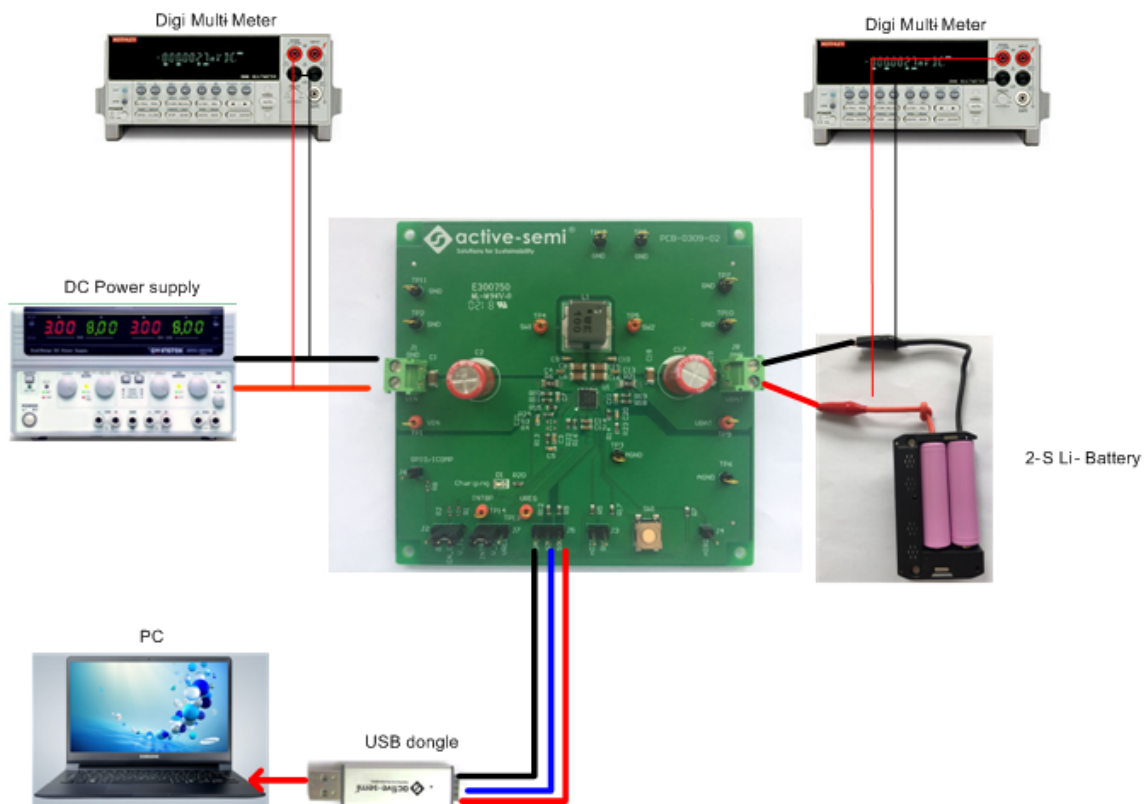

Figure 2 – EVK Setup

## Quick Start

### Hardware Connections for Charge Mode

Refer to Figure 2 for hardware connections to quickly configure the EVK for Charging Mode.

1. Connect a DC power supply to J1. Please ensure the correct power supply polarity.
2. Connect a 2S Li-Battery to J8. Please make sure the correct battery polarity.
3. Connect Digital Multi-Meters to VIN and VBAT to monitor the input voltage and battery voltages.
4. Add a digital Multi-Meter in series with VIN and VBAT if want to observe input and output current.
5. Be careful to keep the input voltage and battery voltage within the specifications.
6. Optional – Connect the EVK to the PC with the USB dongle.
7. Add a jumper to J2 to connect EN\_CHG to V\_IO.
8. Add a jumper to J7 to connect INTBP to V\_IO.
9. Apply 12V input power.

### GUI Setup (optional)

1. Refer to the end of this document for detailed instructions to install the ACT2861 GUI.
2. Connect the USB-TO-I2C dongle to the computer.
3. Connect the USB-TO-I2C dongle to the EVK J5 connector. Refer to Figure 3 to ensure the correct cable connector polarity. As a guide, use the “Active-Semi” logo on the top of the dongle to ensure the black wire is connected to the Dongle GND pin.

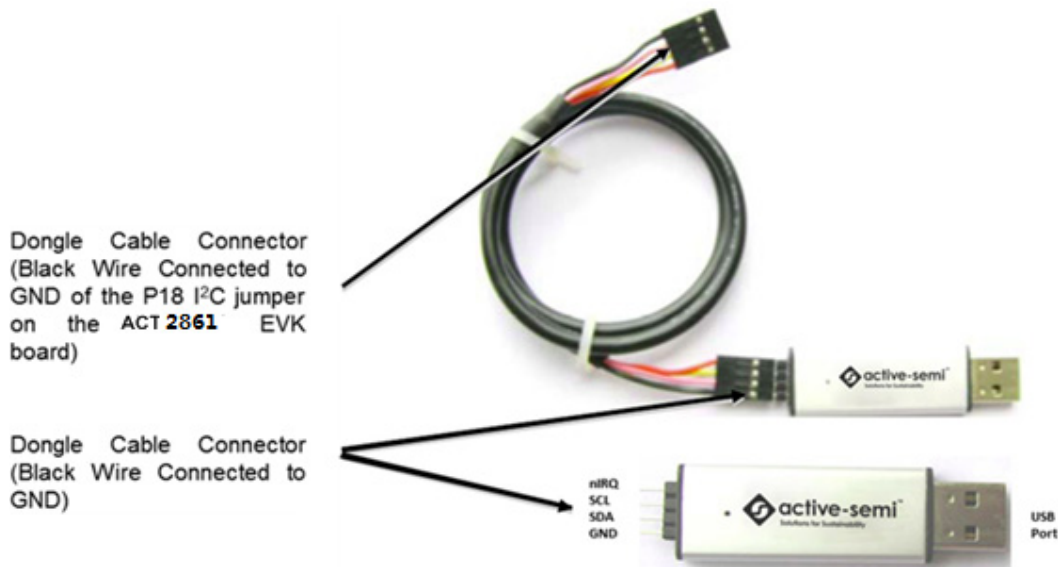

Figure 3 – USB-TO-I2C Dongle Connection

## Recommended Operating Conditions

The ACT2861EVK1-201 is designed for a 4V-29V input voltage. The maximum operating voltage is determined by the IC's maximum input voltage rating. The minimum operating voltage is determined by the buck-boost converter's minimum input voltage. Maximum input and charging currents are determined by resistors and IC's CMI settings, which can be changed via I<sup>2</sup>C after startup.

**Table1. Recommended Operating Conditions**

Parameter	Description	Min	Typ	Max	Unit
VIN	Charger input voltage	4	-	29	V
VBAT	Charger output voltage	0	-	8.4	V
I <sub>VIN_max</sub>	Maximum input current		3		A
I <sub>VBAT_max</sub>	Maximum charge current		3		A
I <sub>VREG_max</sub>	Maximum LDO VREG load current		0.1		A

## EVK Operation

The ACT2861EVK1-201 operates in two different modes: Charger Mode and OTG Mode. The EVK hardware setup is different for each of these two modes.

### Charger Mode Configuration:

1. Connect INTBP and V\_IO together with a jumper on J7.
2. Connect EN\_CHG and V\_IO together with a jumper on J2.
3. Leave the nOTG pin on J3 open.
4. In Charge mode, both an input supply and a battery are required. The EVK can be operated in Charge mode without a battery, but needs the battery to perform actual charging.

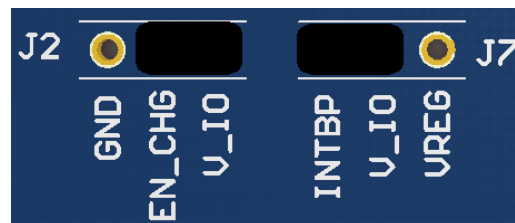

**Figure 4 – Jumper Settings for Charge Mode**

### OTG Mode Configuration:

1. Connect INTBP and V\_IO together with a jumper on J7.
2. Connect nOTG to GND with a jumper on J3.
3. Connect EN\_CHG to GND with a jumper on J2.
4. Connect a load to VIN (J1). This is the OTG output.
5. In OTG mode, either a battery or a power supply must be connected to VBAT (J8). Do not connect a power supply to VIN (J1).

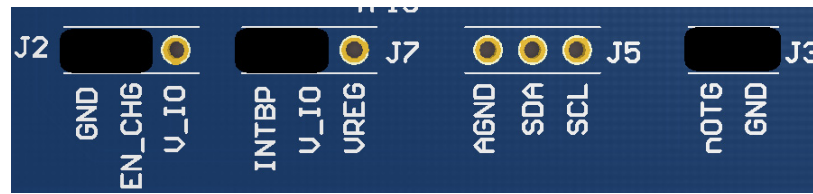

**Figure 5 – Jumper Settings for OTG Mode**

## Turn On the Evaluation Board

Before applying the input voltage, please make sure the jumper (J7) is installed. Connect V\_IO to INTBP or VREG. INTBP is the typical connection.

After power source and battery are connected to the evaluation board per the required connections for either Charge mode or OTG mode, the EVK can be powered for operation. Perform the following steps to turn on the board.

1. In Charge mode, ensure that the power supply connected to VIN (J1) is >4V and <29V.
2. In OTG mode, ensure that the power supply or battery connected to VBAT is >5V and <22.5V.
3. Turn on power supply.
4. Apply the load.
5. If the EVK is configured for OTG mode, the IC automatically goes into SHIP mode when power is applied to VBAT. Push the SW1 button to exit SHIP MODE. When the IC exits SHIP MODE, it goes to HIZ MODE and then OTG mode. Note that I<sup>2</sup>C communication will not work when the IC is in SHIP MODE.

## Charge Current and Current Limit Configuration

The ACT2861 features configurable input current limit, charge current, OTG input current, and OTG output current. These four features are programmed with a combination of an external resistor and an internal I<sup>2</sup>C register. Refer to the ACT2861 datasheet for programming details.

**Input Current Limit** – The ACT2861EVK1-201EVK input current limit is set to 2.03A. This is a function of the 10mΩ current sense resistor, R6, the 33kΩ RILIM resistor, R15, and the I<sup>2</sup>C Input Current Limit bits, INLIMIT, which are set to 67% by default. The input current limit is easily changed by modifying any of these three parameters. The easiest way to change the input current limit is with the Input Current Limit field in the GUI.

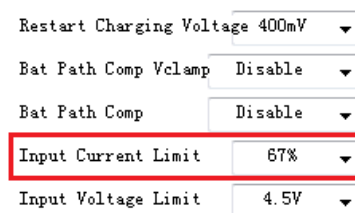

**Charge Current Configuration**- The ACT2861EVK1-201 EVK charge current is set to 1.515A. This is a function of the 10mΩ current sense resistor, R21, the 33kΩ ROLIM resistor, R14, and the I<sup>2</sup>C Fast Charge bits, IFCHG, which are set to 50% by default. The charge current is easily changed by modifying any of these three parameters. The easiest way to change the charge current limit is with the Fast Charge field in the GUI.

In addition, short current, pre-charge current, termination detection current can also be modified by the ACT2816 GUI.

**CHARGER**

Charge Status	Fastchg
Battery Regulation Voltage	3.40V
<b>Fast Charge Current</b>	<b>50%</b>
Pre-charge Current	5%
Termination Detection Current	.
Battery Short Charge Current %	

**OTG Input Current Limit Configuration** - The ACT2861EVK1-201 EVK OTG current limit is set to 6.06A. This is a function of the 10mΩ current sense resistor, R21, the 33kΩ ROLIM resistor, R14, and the I<sup>2</sup>C OTG Battery Ilim bits, OTG\_BAT\_ILIM, which are set to 200% by default. The OTG input current limit is easily changed by modifying any of these three parameters. The easiest way to change the input current limit is with the OTG Battery Ilim field in the GUI.

**OTG**

OTG Status	OTG_RST
OTG Output Voltage	5.10V
OTG Vbat Cut Off/batlow	0.4
OTG Soft Start Time	10ms
OTG Off Delay	30s
OTG Startup Delay	1s
OTG Vout Slew	0.5V/ms
<b>OTG Battery Ilim</b>	<b>200% of Ifc</b>
OTG Constant Current	100%
OTG Cord Comp	Disable

**OTG Output Current Limit Configuration** - The ACT2861EVK1-201 EVK OTG output current limit is set to 3.03A. This is a function of the 10mΩ current sense resistor, R6, the 33kΩ RILIM resistor, R15, and the I<sup>2</sup>C OTG Current Limit bits, OTC\_CC, which are set to 100% by default. The OTG output current limit is easily changed by modifying any of these three parameters. The easiest way to change the input current limit is with the OTG Current Limit field in the GUI.

**OTG**

OTG Status	OTG_RST
OTG Output Voltage	5.10V
OTG Vbat Cut Off/batlow	0.4
OTG Soft Start Time	10ms
OTG Off Delay	30s
OTG Startup Delay	1s
OTG Vout Slew	0.5V/ms
OTG Battery Ilim	200% of Ifc
<b>OTG Constant Current</b>	<b>100%</b>
OTG Cord Comp	Disable

## Additional Programmable Functionality

The ACT2861 contains many additional programmable parameters. Refer to the ACT2861 datasheet for additional functionality and default I<sup>2</sup>C register values.

## Test Results

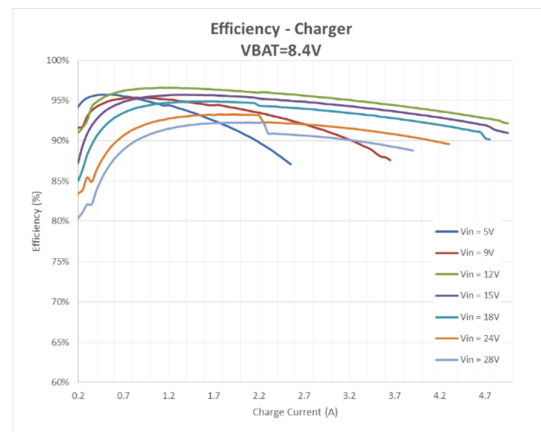
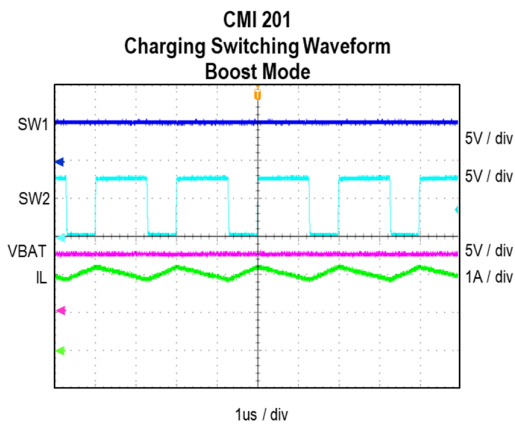
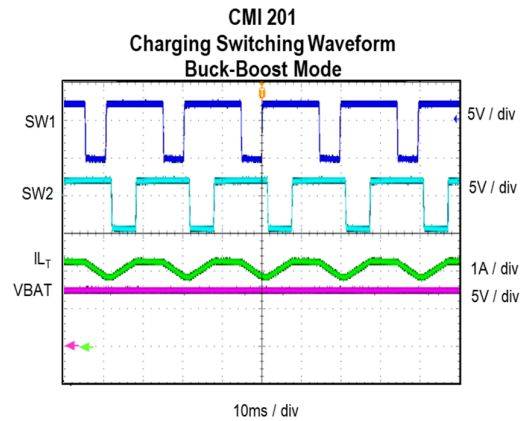
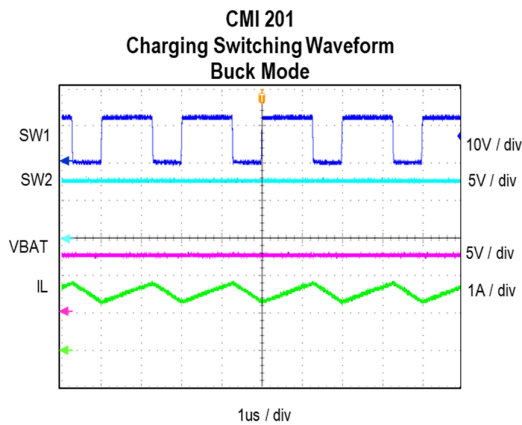
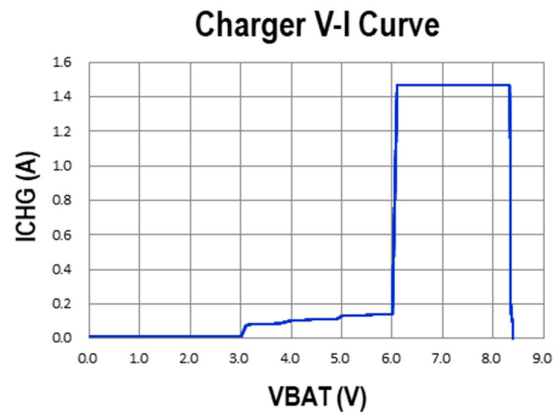
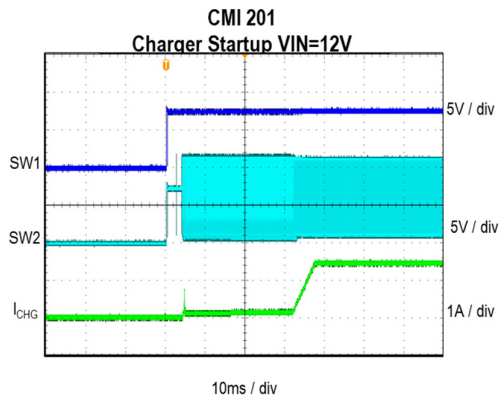

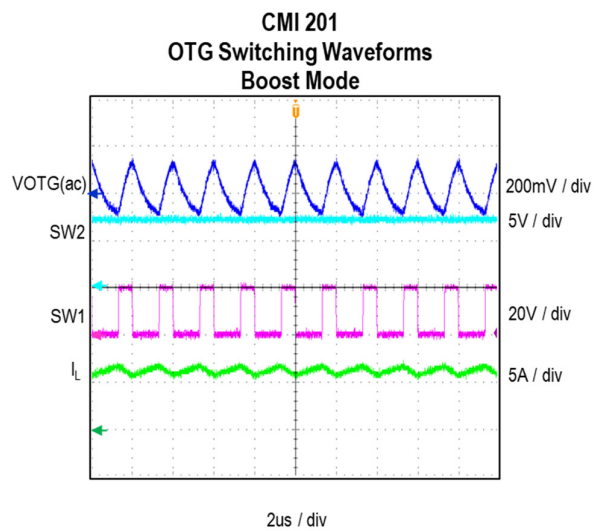
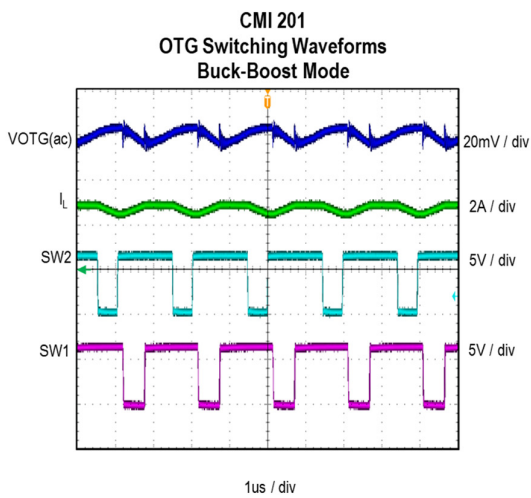
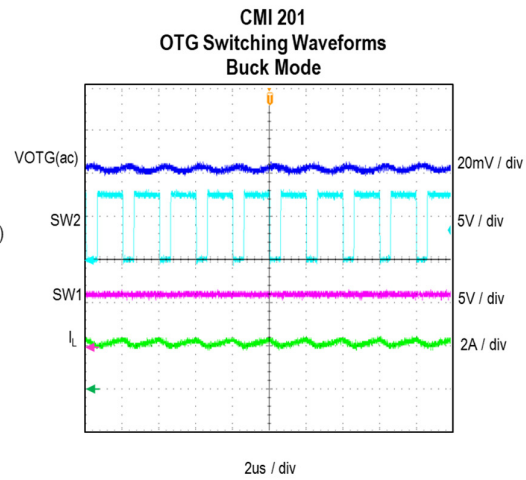
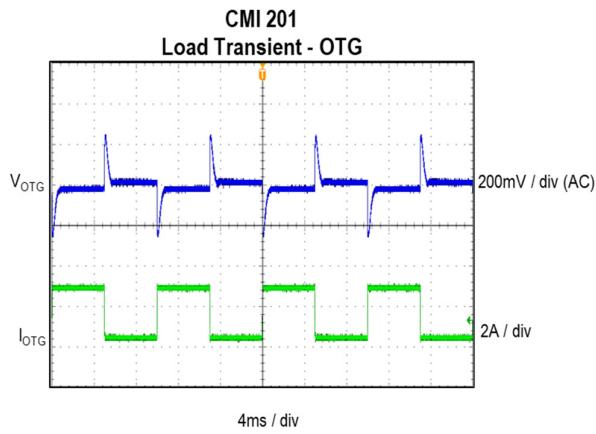
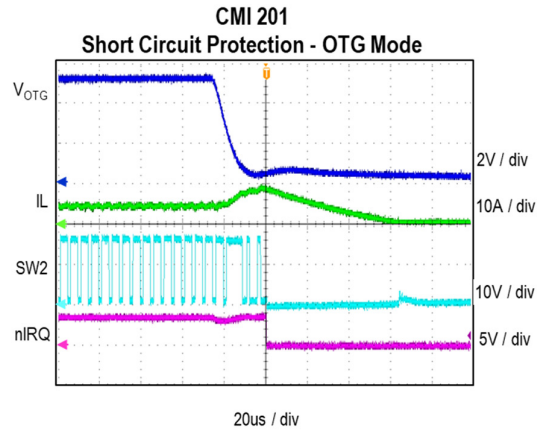
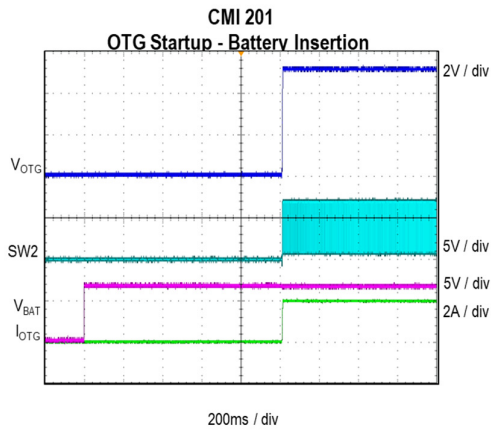



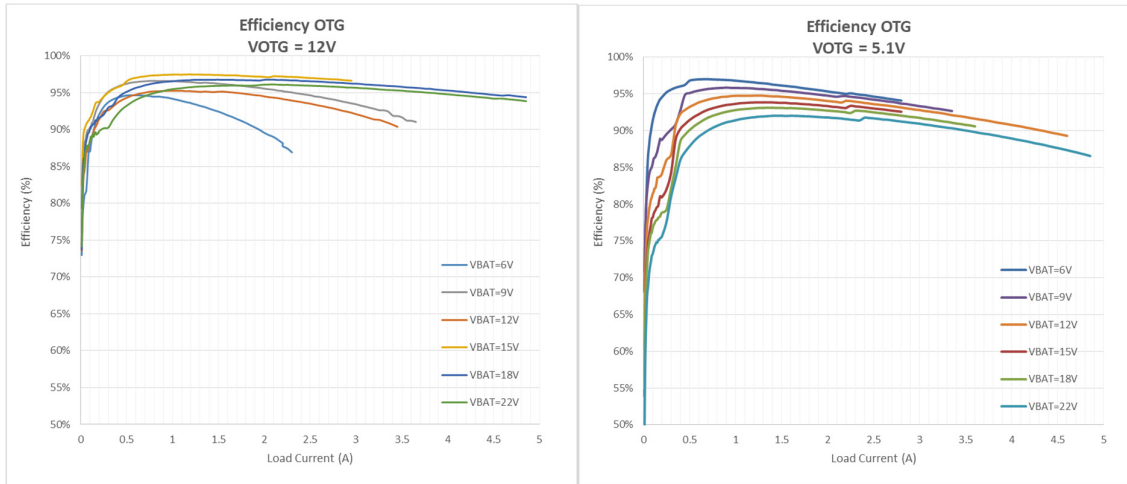

**Schematic**

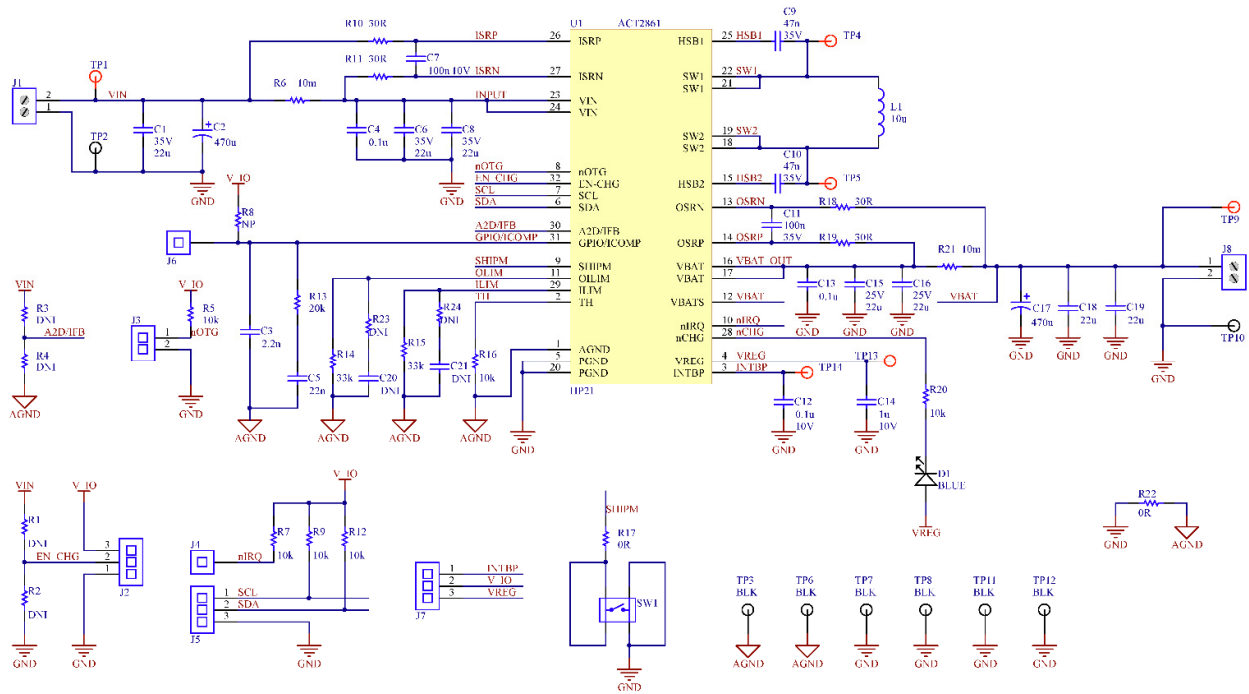

**Layout**

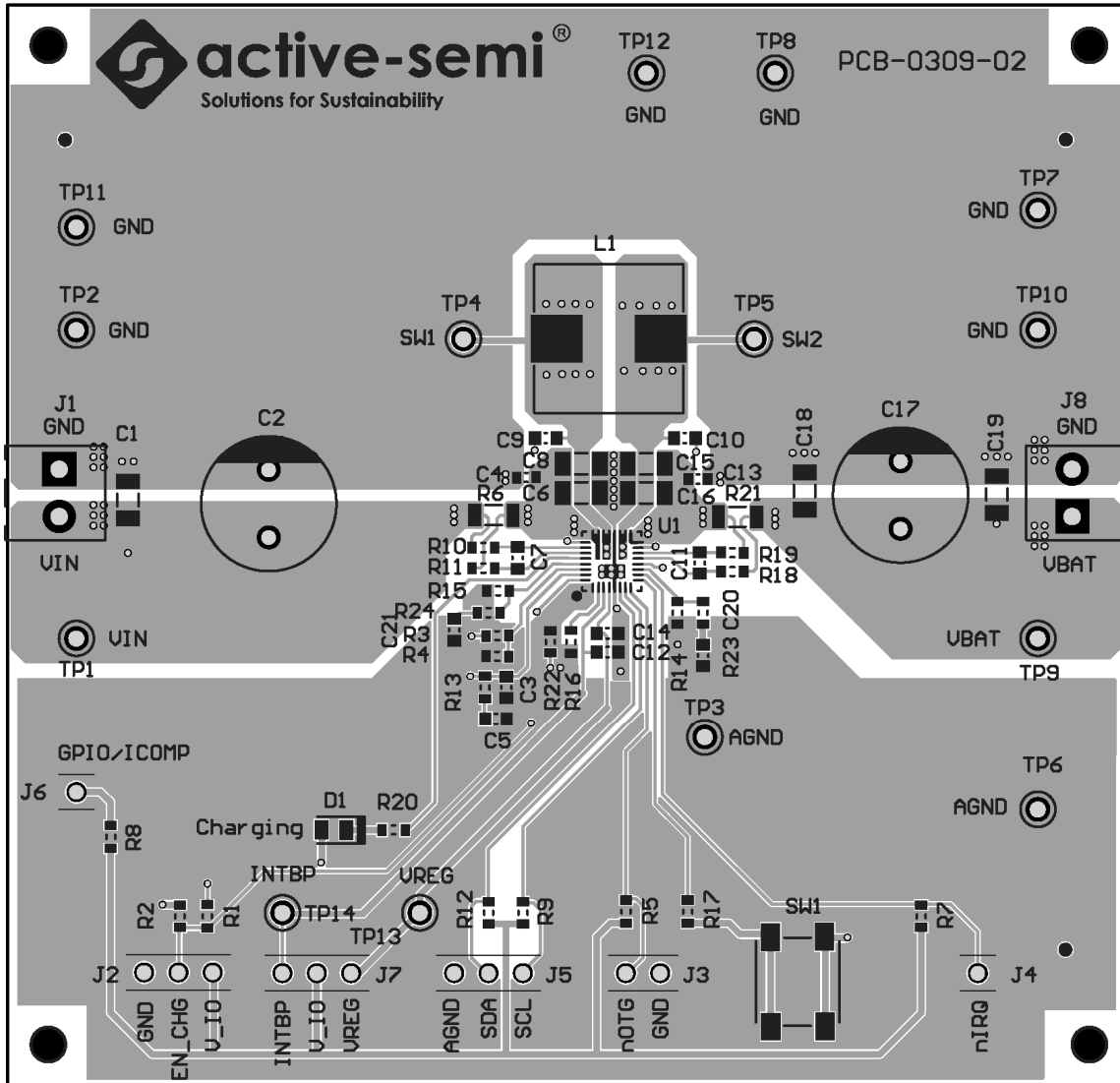

**Figure 5 –Layout Top Layer**

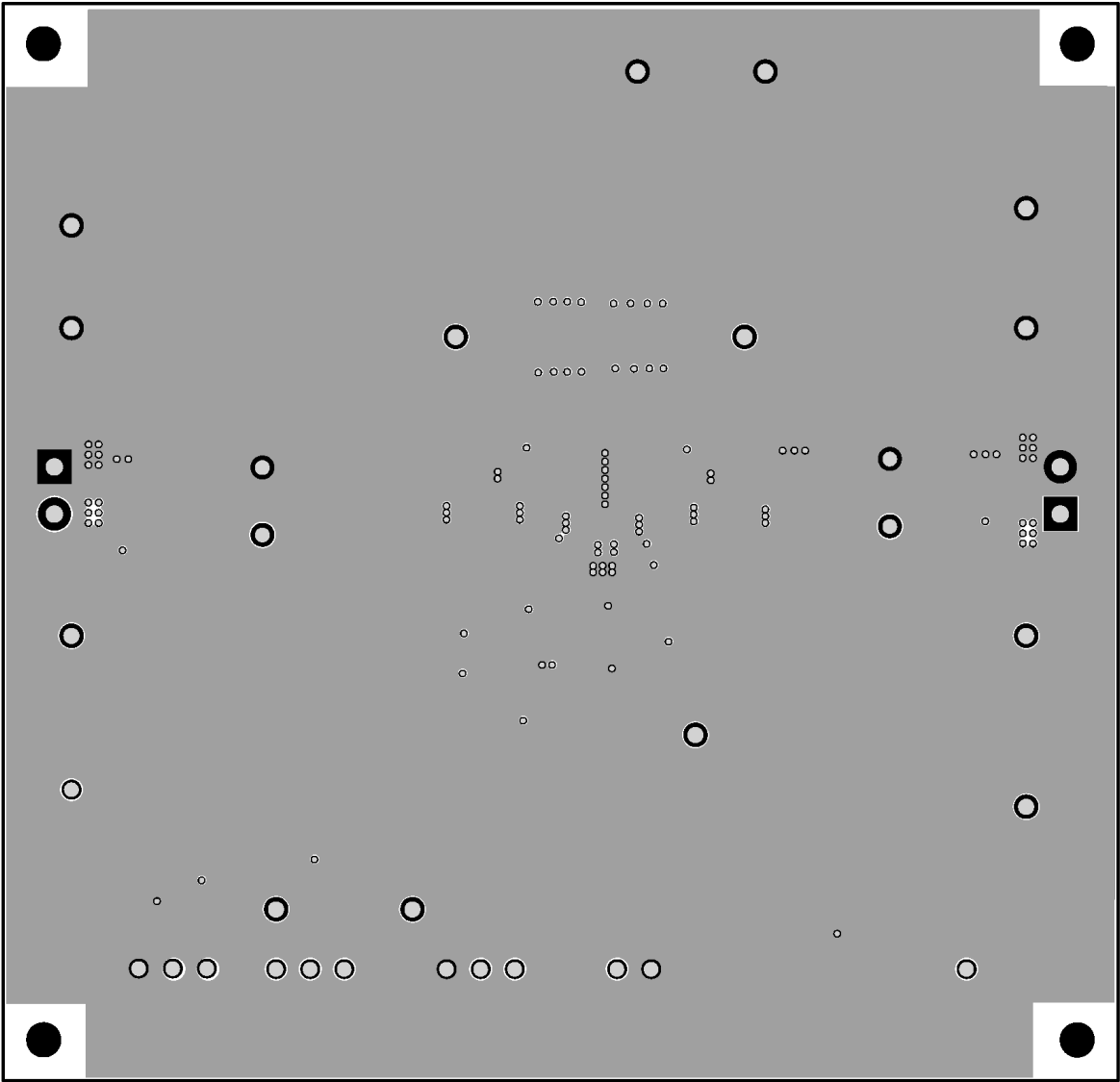

Figure 6 –Layout Layer GND

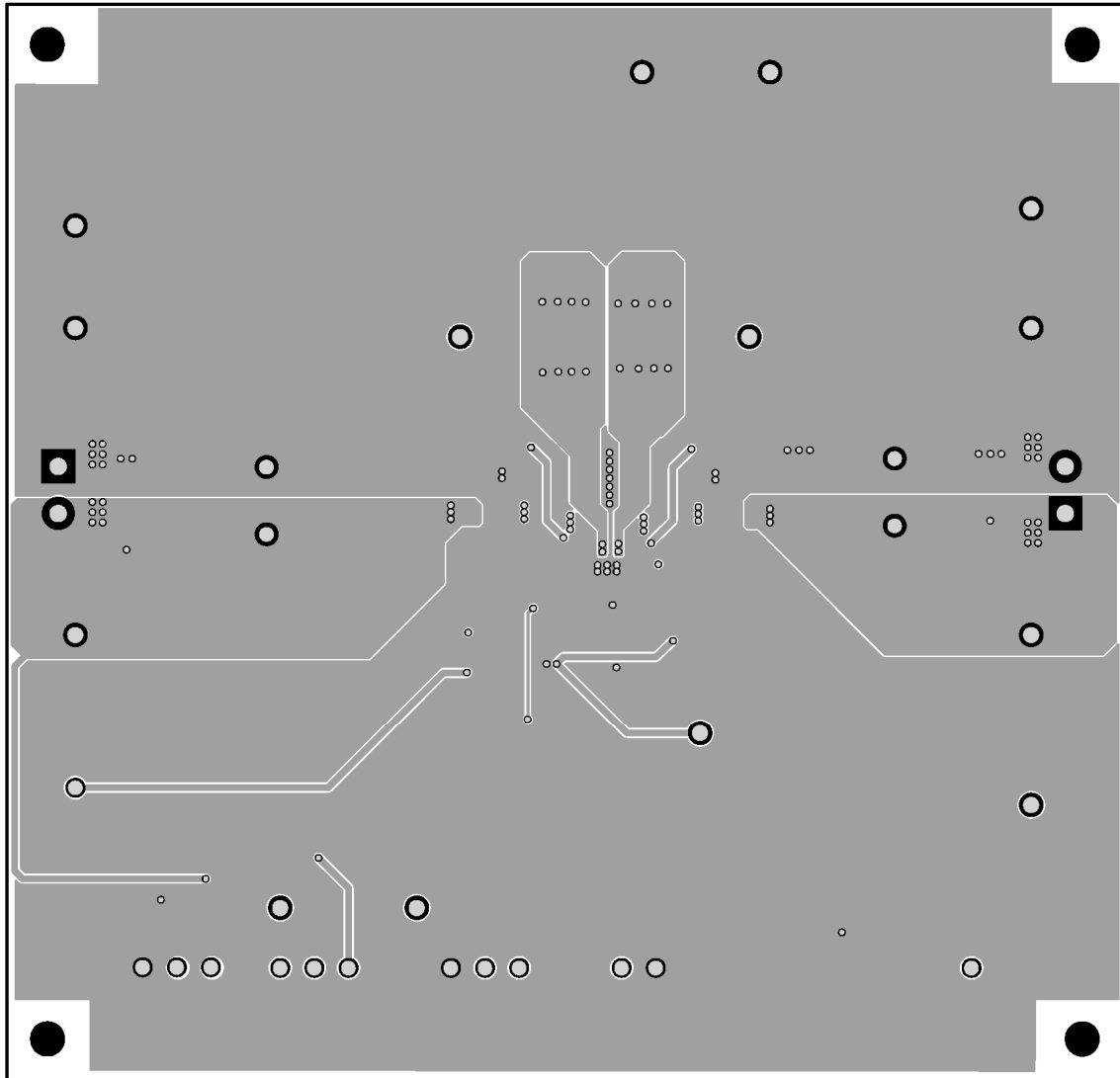

Figure 7 –Layout Layer VCC

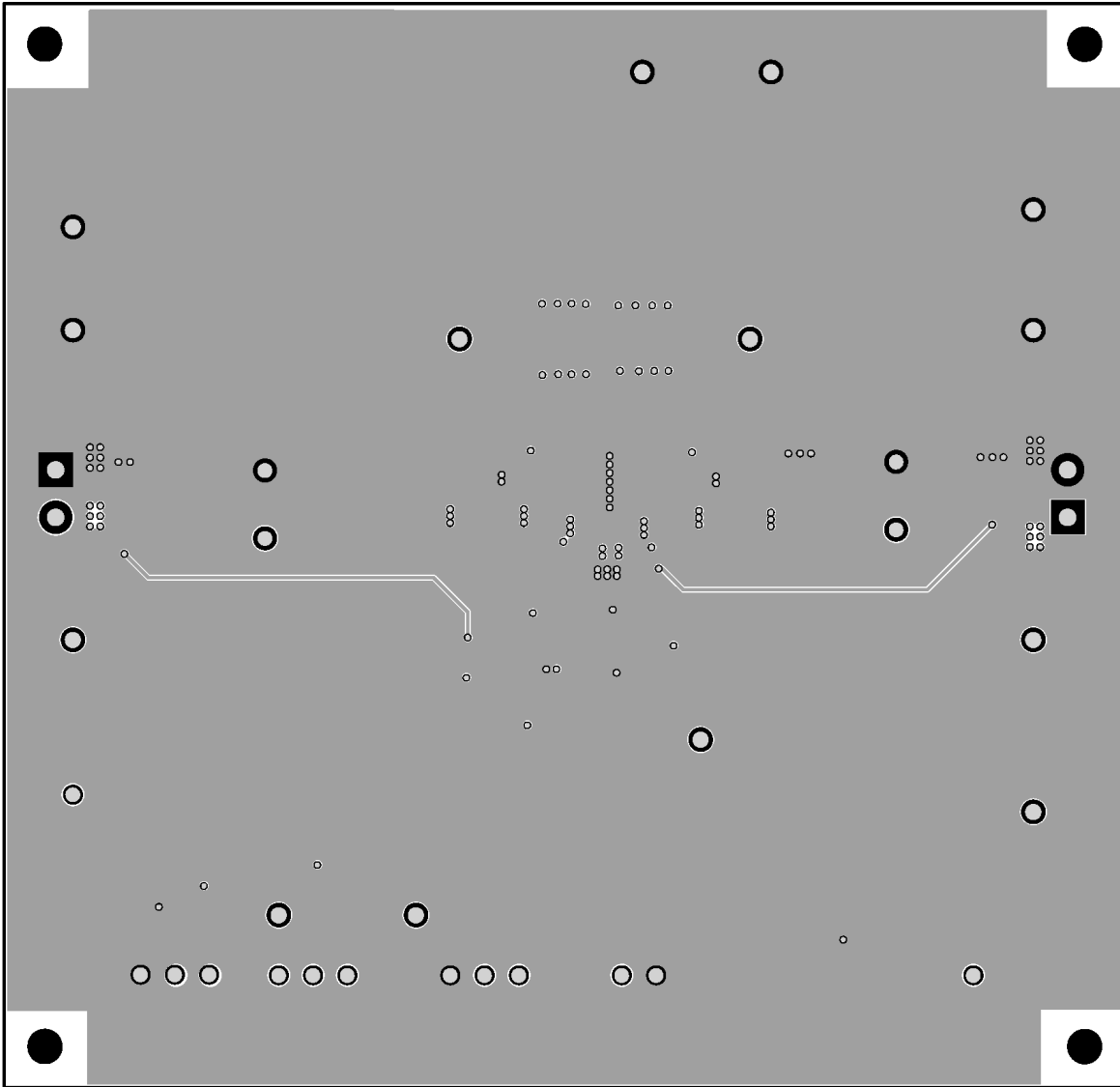

Figure 8 –Layout Bottom Layer





**Bill of Materials**
**Table 2. ACT2861EVK1-201 BOM**

Item	Ref Des	QTY	Description	Package	MFR	Part Number
1	C1, C6, C8, C15, C16, C18, C19	7	Cap, Ceramic, 22uF, 35V, 10%, X7R	1206	TDK	C3216X5R1V226M160AC
2	C2	1	ELCap, 470uF, 25V	8mmx11mm	Würth Elektronik	860010675020
3	C3	1	Cap, Ceramic, 2.2nF, 35V, 10%, X7R	0603	std	std
4	C4, C7, C11, C12, C13	5	Cap, Ceramic, 0.1uF, 35V, 10%, X7R	0603	Würth Elektronik	885012206020
5	C5,	1	Cap, Ceramic, 22nF, 35V, 10%, X7R	0603	std	std
6	C9, C10	2	Cap, Ceramic, 47nF, 35V, 10%, X7R	0603	Würth Elektronik	885012206093
7	C14	1	Cap, Ceramic, 1uF, 10V, 10%, X7R	0603	Würth Elektronik	885012206026
8	C17	1	ELCap, 470uF, 16V	8mmx11mm	Würth Elektronik	860020374012
9	C20, C21	0	DNI	0603	std	std
10	D1	1	LED, Blue	0603	Würth Elektronik	150060VS75000
11	J1, J8	2	Connector, 2 pin		Würth Elektronik	691214110002S
12	J3	1	Header, 2 pin, 100mil		Würth Elektronik	61300211119
13	J4, J6	2	Header, 1pin, 100mil		Würth Elektronik	61300211119
14	J2, J5, J7	3	Header, 3 pin, 100mil		Würth Elektronik	61300211119
15	L1	1	Würth inductor 10uH	6mmx6mmx6mm	Würth Elektronik	74439346100
16	R1, R2, R3, R4, R8, R23, R24	0	DNI	0603	std	std
17	R5, R7, R9, R12, R16, R20	6	Res, 10kΩ, 1%	0603	std	std
18	R6, R21	2	Res, 10mΩ, 1%	1206	std	std
19	R10, R11, R18, R19	4	Res, 30Ω, 1%	0603	std	std
20	R13	1	Res, 20kΩ, 1%	0603	std	std
21	R14, R15	2	Res, 33kΩ, 1%	0603	std	std
22	R17, R22	2	Res, 0Ω, 1%	0603	std	std
23	SW1	1	SMT Tact switch 4mmx4mmx1.5mm	4mmx4mmx1.5mm	Würth Elektronik	430481035816
24	TP1, TP4, TP5, TP9, TP13, TP14	6	Test Point, Red, Through Hole, 1mm	0.040"	Keystone	5000
25	TP2, TP3, TP6, TP7, TP8, TP10,	8	Test Point, Black, Through Hole, 1mm	0.040"	Keystone	5000

	TP11, TP12					
26	U1	1	ACT2861QI922	4mm×4mm QFN	Active Semi	std
27	--	1	PCB, ACT2861EVK1 REVB	n/a	n/a	PCB-0309-02
28	--	3	Shunt, 100mil, Black	n/a	n/a	60900213421

## GUI Installation

1. Get GUI files from the Active Semi website
2. Plug the USB-TO-I2C dongle into a free USB port.
3. Follow the instructions in the “How to install driver for dongle” folder.
4. Double click on the ACT2861 GUI.exe to start the ACT2861 GUI.

 ACT2861 GUI User Guide	2017/9/5 10:41	532 KB	Adobe Acrobat 7.0 Document
 Active Semi GUI and Dongle Driver Installation	2017/3/20 17:11	1,235 KB	Adobe Acrobat 7.0 Document
 ACT2861_REV1.4.cpmu	2018/2/21 17:12	75 KB	CPMU 文件
 ACT2861 Active GUI	2017/10/2 11:12	5,953 KB	应用程序

## GUI Overview

The GUI has 2 basic function buttons allocated in top-left of the Tool Bar which are Read and Write I<sup>2</sup>C. The GUI contains 2 setting modes: Basic Mode and Advanced Mode. In Basic Mode screen it displays basic user programmable configuration options are programmed using the drop-down boxes or check boxes. Advanced Mode contain the button text for changing setting for every single bit.

### Basic Mode

The following figure shows the GUI in basic mode. This mode allows the user to easily change one or more IC settings.

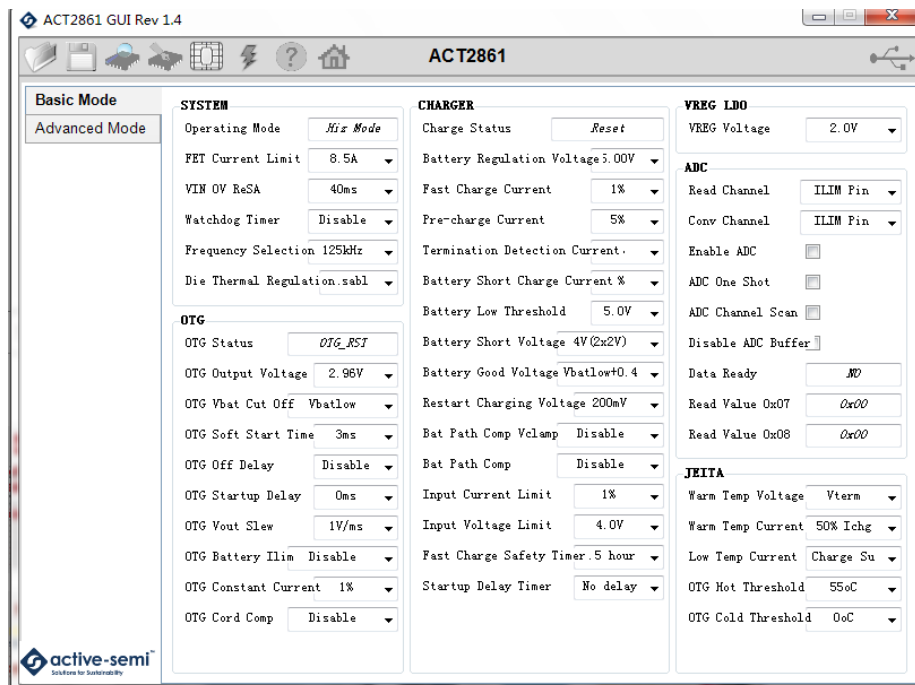



### Advanced Mode

Click the “Advanced Mode” button in the left of the GUI screen to see all available user programmable options. With Advanced Mode, additional user programmable features can be selected using the button text. In the left side of the Advanced Mode Screen, click on the Tiles Selector to display the register to view or change. Then change a register one bit at a time by clicking on the desired bit. The value of the bit is display right next to the bit-name button.

Note that the far right side of the screen contains a scroll down button to scroll down to additional registers since the Tile Screen can only display up to 8 bytes at once.

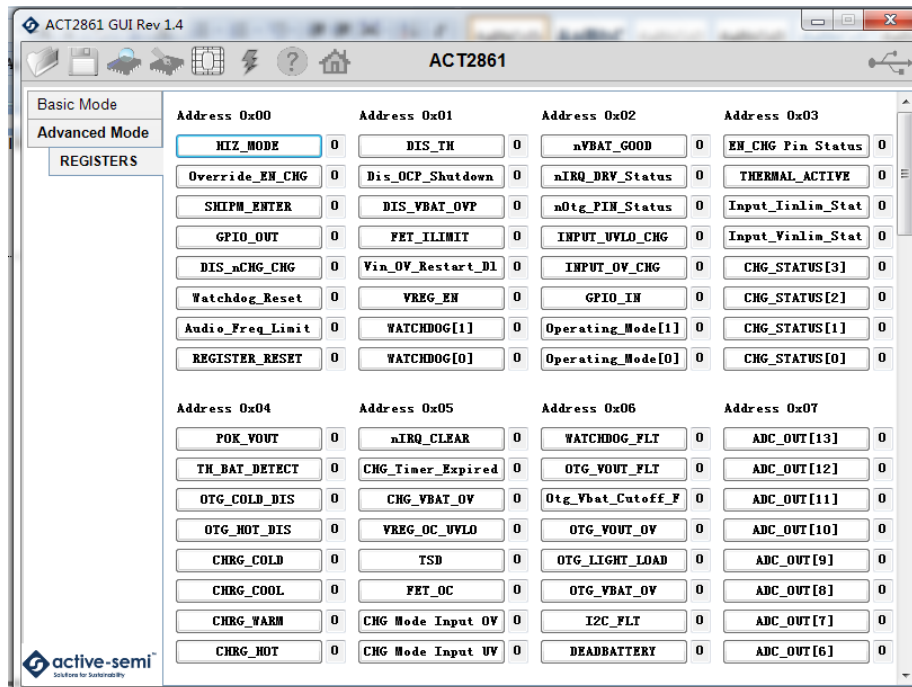

**Button Descriptions**

**Read:** Clicking on this button reads the ACT2861 registers and displays them in the GUI. Note that this reads all registers. Active-Semi recommends reading registers each time the ACT2861 powers-up to acquire the initial register settings. Active-semi also recommends reading registers after making changes to them. Immediately reading the registers after a write confirms the changes were properly stored.



Read Button

**Write:** Clicking on this button writes the GUI settings to the ACT2861's registers. All registers are written, regardless of whether or not they were changed.



Write Button

**Dongle Connection Status:** The GUI also contains a dongle connection status that indicates Active-Semi's USB-TO-I2C dongle is connected to the USB port. The figure below shows the two possible indication status graphics.

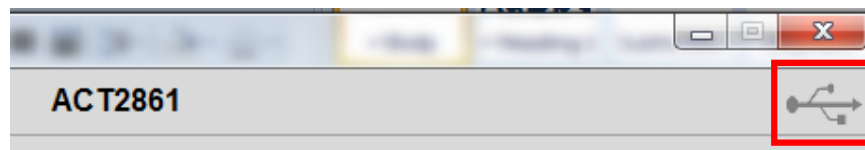

Dongle connected

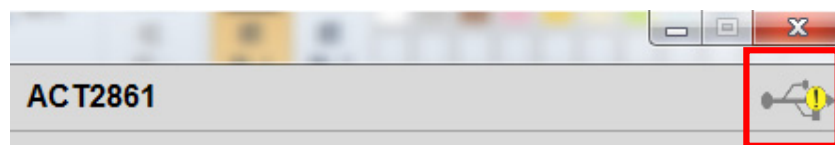

Dongle Disconnected