



T-3 1/4
WITH MINIATURE
BAYONET BASE

See lamp ratings
on page K.

Large Incandescent Indicators

FOR MOUNTING IN 1" CLEARANCE HOLE

FOR 2 TO 120V OPERATION

For materials and finishes of products
in this group, see page 16D.

WITH SCREW-ON LENS CAPS



19 SERIES

19-0410-0531-301
Large Torpedo lens

BASE PART NUMBERS



19-0410-05-301

19-1310-05-301

CAP PART NUMBERS

COMPLETE ASSEMBLY PART NUMBERS



19-0410-0511-301
19-0410-0531-301

19-1310-0511-301
19-1310-0531-301

WITH SCREW-ON LENS CAPS



51-0410-0431-301
Faceted lens

51 SERIES

BASE PART NUMBERS

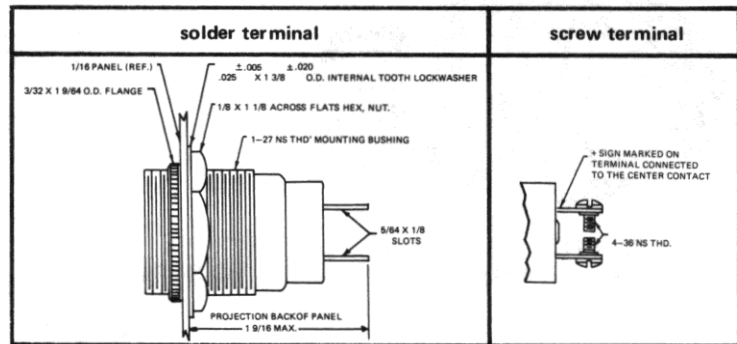

51-0410-01-301

51-1310-01-301

CAP PART NUMBERS

COMPLETE ASSEMBLY PART NUMBERS

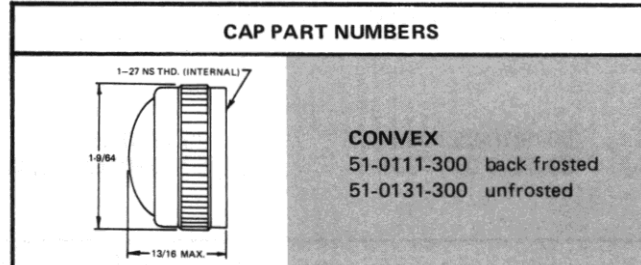

51-0410-0111-301
51-0410-0131-301

51-1310-0111-301
51-1310-0131-301

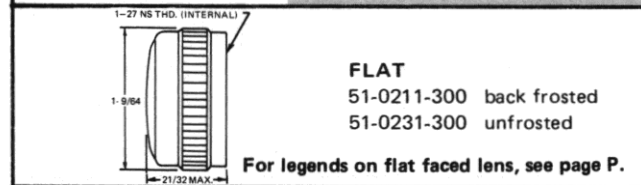

51-0410-0211-301
51-0410-0231-301

51-1310-0211-301
51-1310-0231-301

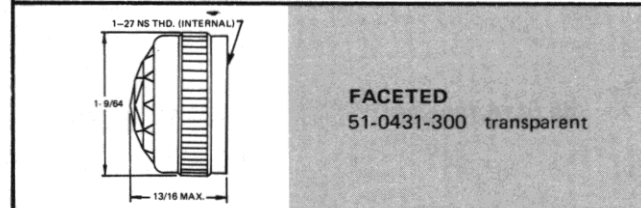

51-0410-0431-301

51-1310-0431-301

Part numbers listed in this catalog designate products with RED lens.
For ordering lens colors other than red, consult chart on page 2D.

Part numbers shown in gray are normally
in inventory at your Dialight Distributor.