

**SF2276D-2**

**453.75 MHz  
SAW Filter**

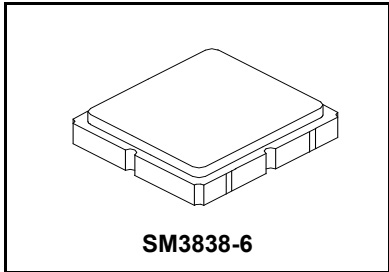

- **Low-loss SAW Filter**
- **No Matching Required for 50 ohm Source/Load**
- **3.8 x 3.8 x 1.4 mm Surface-mount Package**
- **Complies with Directive 2002/95/EC (RoHS)**



**Absolute Maximum Ratings**

Rating	Value	Units
Maximum Incident Power in Passband	+10	dBm
Maximum DC Voltage on any Non-ground Terminals	5	VDC
Operable Temperature Range	-45 to +125	°C
Specification Temperature Range	-20 to +80	°C
Storage Temperature Range in Tape and Reel	-40 to +85	°C
Suitable for Lead-free Soldering - Maximum Soldering Profile	260 °C for 30 s	

**Electrical Characteristics**

Characteristic	Sym	Notes	Min	Typ	Max	Units
Center Frequency	$f_c$	1		453.75		MHz
Insertion Loss, 450.0 to 457.5 MHz, -10 to +60 °C	IL				3.5	5.0
Amplitude Ripple, 450.0 to 457.5 MHz, -10 to +60 °C				1.0	3.0	dB <sub>P-P</sub>
Input Return Loss, 450.0 to 457.5 MHz			5	6		dB
Output Return Loss, 450.0 to 457.5 MHz			5	6		dB
Rejection Referenced to 0 dB:		1, 2, 3				dB
300 to 350 MHz			27	30		
350 to 445 MHz			25	28		
460 to 470 MHz, -10 to +60 °C			8	15		
470 to 2000 MHz			16	18		
Single-ended Source Impedance	50 ohm					
Single-ended Load Impedance	50 ohm					

Case Style	SM3838-6 3.8 x 3.8 mm Nominal Footprint		
Lid Symbolization (Y=year, WW=week, S=shift) dot=pin 1 indicator	A24, <u>YWWS</u>		
Standard Reel Quantity	Reel Size 7 Inch	500 Pieces/Reel	
	Reel Size 13 Inch	3000 Pieces/Reel	

**Electrical Connections**

Connection	Terminals
Port 1	2
Port 2	5
Case Ground	All others



**CAUTION: Electrostatic Sensitive Device. Observe precautions for handling.**

**Notes:**

1. Unless noted otherwise, all specifications apply over the operating temperature range with filter soldered to the specified demonstration board with impedance matching to 50 Ω and measured with 50 Ω network analyzer.
2. Unless noted otherwise, all frequency specifications are referenced to the nominal center frequency,  $f_c$ .
3. Rejection is measured as attenuation below the minimum IL point in the passband. Rejection in final user application is dependent on PCB layout and external impedance matching design. See Application Note No. 42 for details.
4. "LRIP" or "L" after the part number indicates "low rate initial production" and "ENG" or "E" indicates "engineering prototypes."
5. The design, manufacturing process, and specifications of this filter are subject to change.
6. Either Port 1 or Port 2 may be used for either input or output in the design. However, impedances and impedance matching may vary between Port 1 and Port 2, so that the filter must always be installed in one direction per the circuit design.
7. US and international patents may apply.
8. Murata, stylized Murata logo, and Murata N.A., Inc. are registered trademarks of Murata Manufacturing Co., Ltd.

# Filter Response Plots

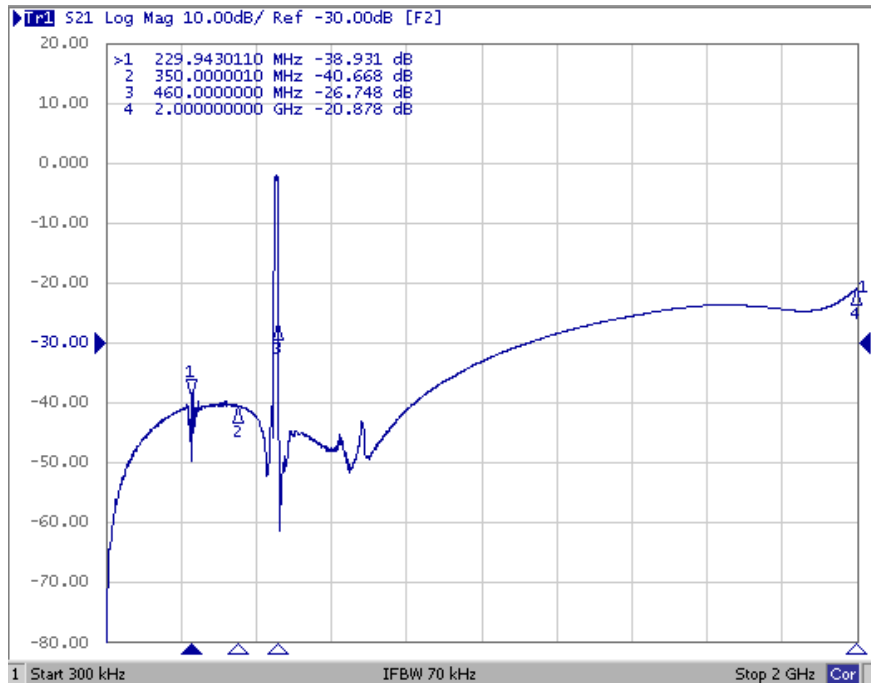
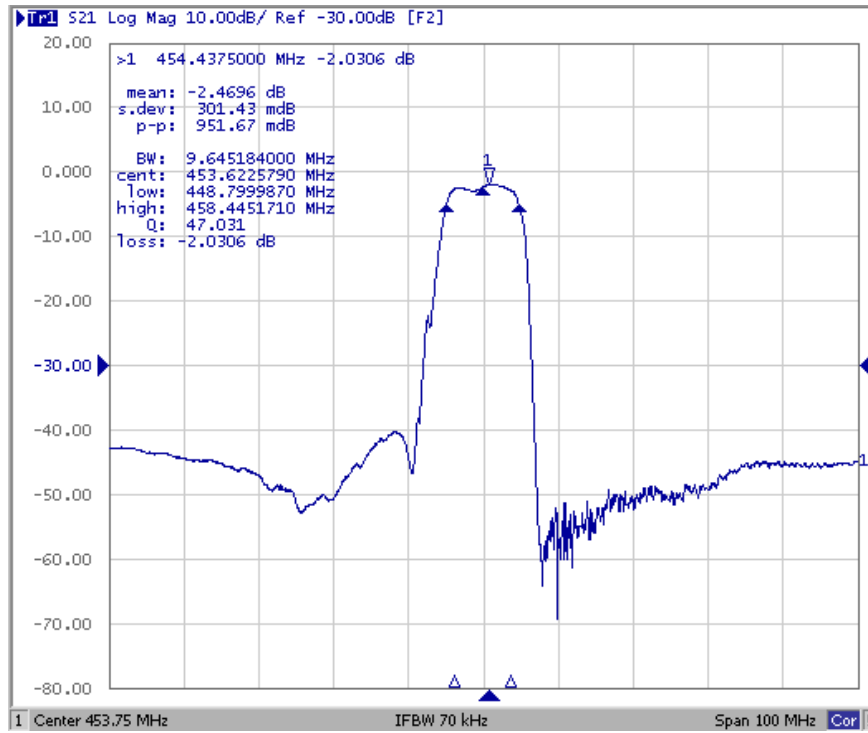

## Filter Input and Output Impedance Plots

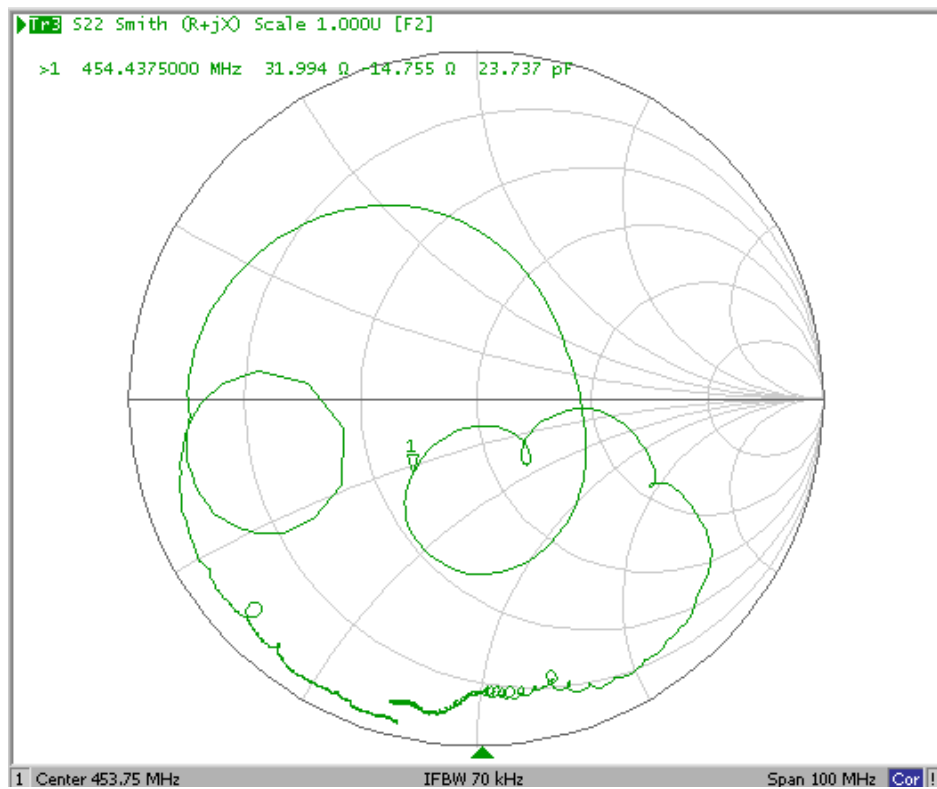
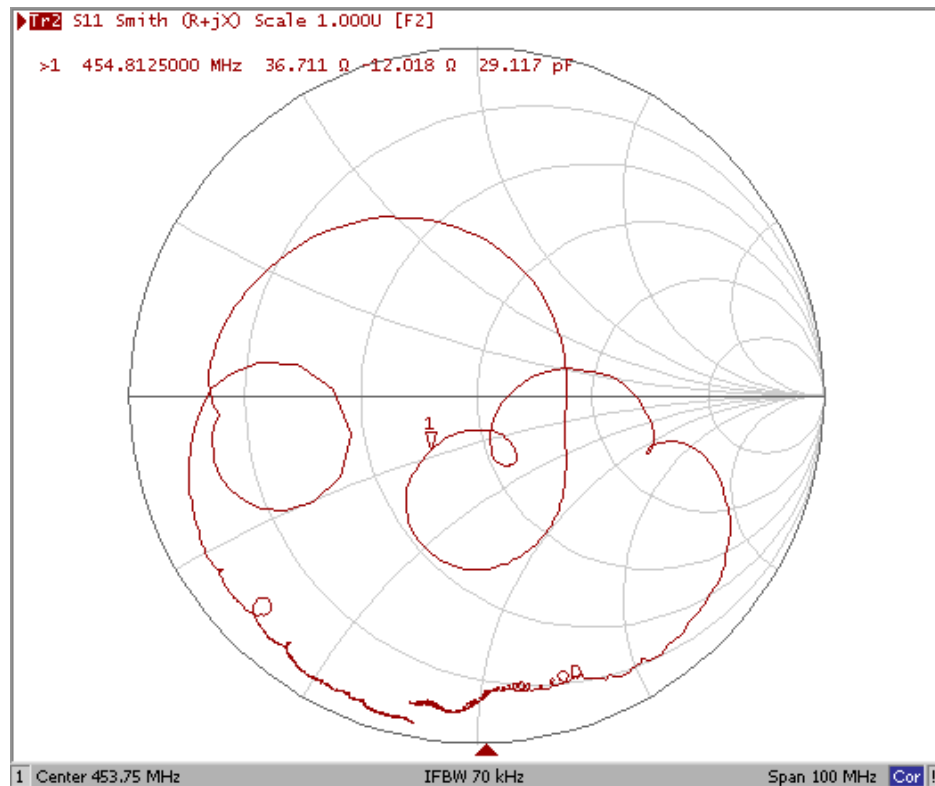

# Filter Passband Detail

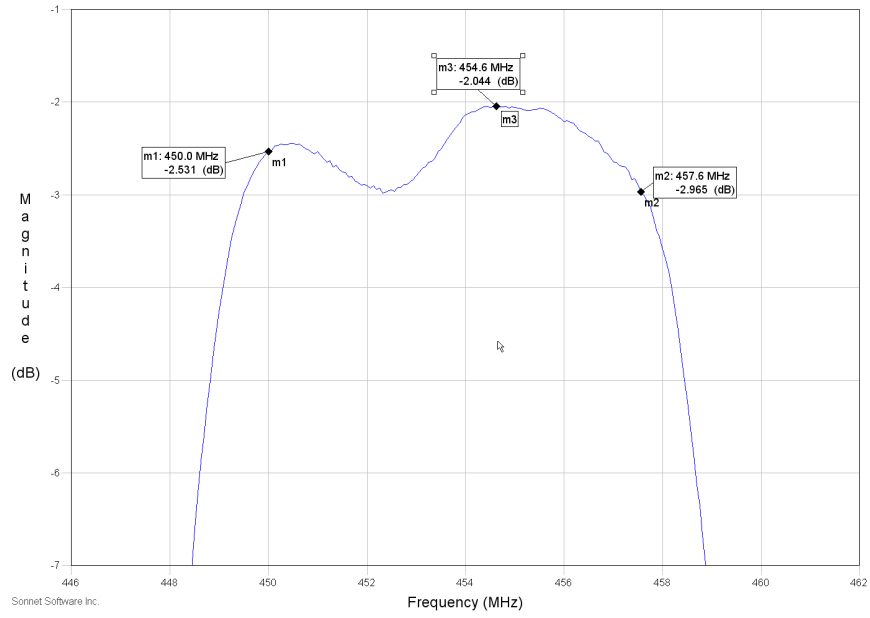

# SM3838-6 Case

## 6-Terminal Ceramic Surface-mount Case

### 3.8 X 3.8 mm Nominal Footprint

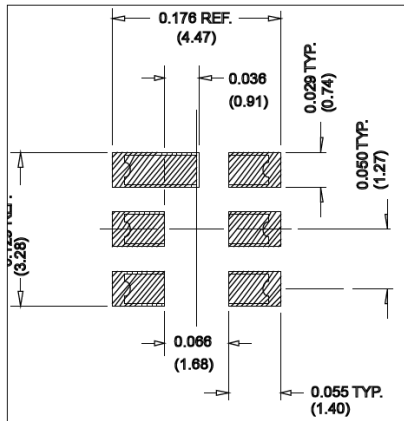
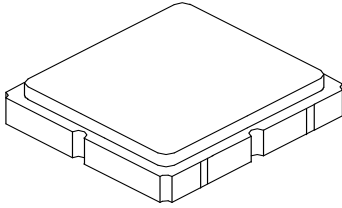

Typical PCB Land Footprint

#### Case Dimensions

Dimension	mm			Inches		
	Min	Nom	Max	Min	Nom	Max
A	3.60	3.80	4.00	0.140	0.150	0.016
B	3.60	3.80	4.00	0.140	0.150	0.016
C	1.07	1.25	1.43	0.050	0.060	0.067
D	0.95	1.10	1.25	0.037	0.043	0.050
E	2.39	2.54	2.69	0.090	0.100	0.110
G	0.90	1.00	1.10	0.035	0.040	0.043
H	1.90	2.00	2.10	0.750	0.080	0.830
I	0.50	0.60	0.70	0.020	0.024	0.028
J	1.70	1.80	1.90	0.067	0.070	0.075

#### Materials

Solder Pad Plating	0.3 to 1.0 $\mu\text{m}$ Gold over 1.27 to 8.89 $\mu\text{m}$ Nickel
Lid Plating	2.0 to 3.0 $\mu\text{m}$ Nickel
Body	$\text{Al}_2\text{O}_3$ Ceramic
Pb Free	

#### TOP VIEW

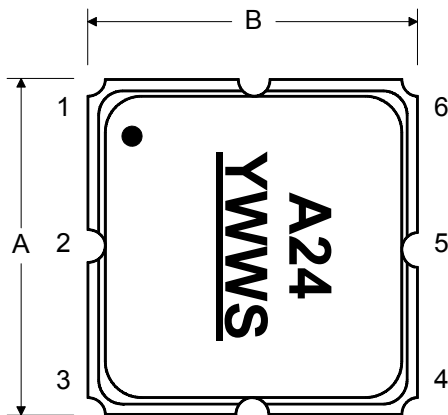

#### BOTTOM VIEW

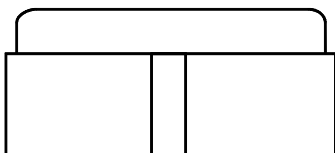
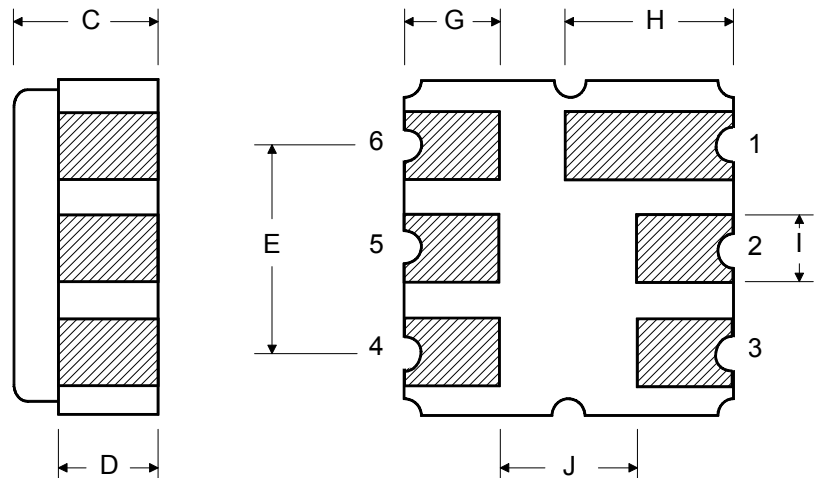

## Tape and Reel Specifications

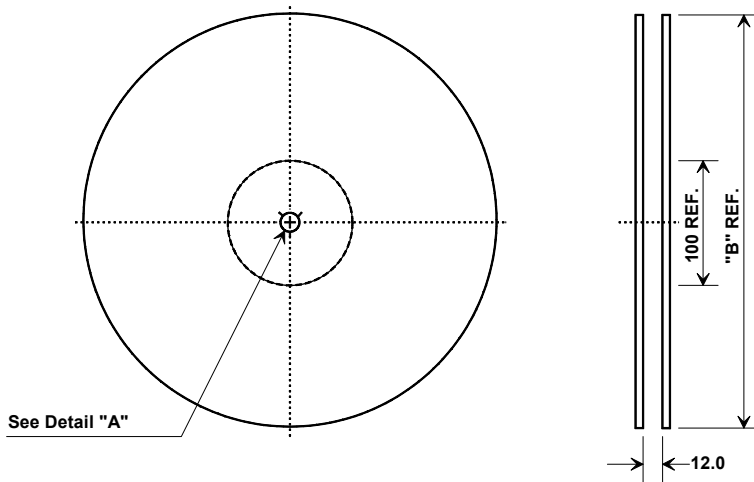

"B"		Quantity Per Reel
Nominal Size		
Inches	millimeters	
7	178	500
13	330	3000

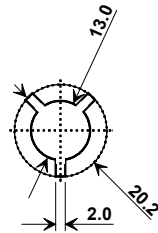

## COMPONENT ORIENTATION and DIMENSIONS

Carrier Tape Dimensions	
Ao	4.25 mm
Bo	4.25 mm
Ko	1.30 mm
Pitch	8.0 mm
W	12.0 mm

