



TAM813

TAM

Capillary tube thermostats with 1.5 m capillary tube

The sensor cartridge at the end of the capillary tube is the actual active (temperature-sensitive) part of the sensor. Changes in temperature on the capillary tube have no effect on the

switching point. Pressure-tight installation of the sensor in pressure vessels of all kinds is possible with the aid of an immersion well.

SIL 2 according IEC 61508-2



Technical data

Body	Diecast aluminium GD Al Si 12 according to DIN 1725.
Mounting position	Any, preferably vertical
Max. ambient temperature at switching device	+70°C
Capillary tube	Cu capillary tube, 1.5 m long Other capillary tube lengths are not possible
Sensor cartridge	8 mm Ø, 100 mm long, material: Cu
Contact arrangement	Single pole changeover switch
Switching capacity	8 (5) A 250 VAC
Degree of protection	IP 54 according to DIN EN60529 (with vertical installation)
Mounting	Temperature sensor with or without immersion tube in containers, air ducts etc. Switching device with 2 screws (Ø 4) directly on a flat wall surface
Calibration	Scale value corresponds to the lower switching point (with falling temperature), the upper switching point is higher by the amount of the switching differential
Plug connection	Via angled plug to DIN EN175301
Switching temperature	Adjustable via the setting spindle with a screw-driver
Switching differential	Not adjustable

Product Summary

Type	Setting range	Switching differential (mean values)	Max. permissible temperature at sensor
TAM022	-20 to + 20 °C	1.5 K	110 °C
TAM150	+10 to + 50 °C	1.5 K	110 °C
TAM490	+40 to + 90 °C	2.0 K	125 °C
TAM813	+80 to +130 °C	2.0 K	150 °C

-TAM see page 119

+ Accessories

Immersion tube type ... R 1, R 2, R 3, RN 1, RN 2, see page 157.

Dimensioned drawing (mm)

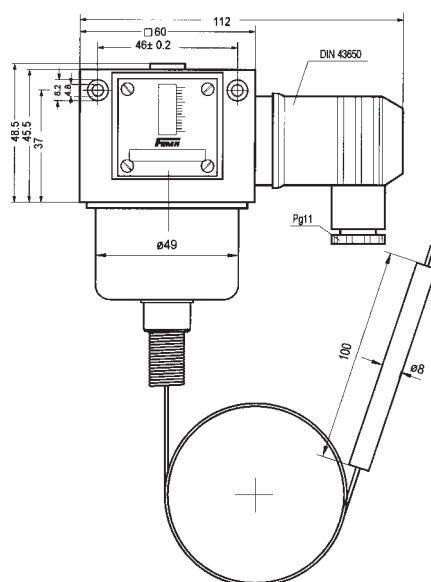

General technical information

for series TX, TRM and TAM

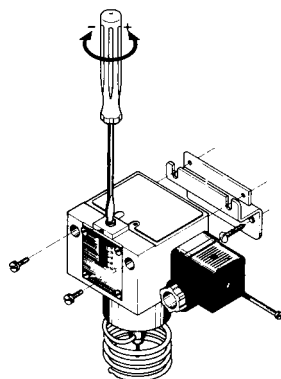

Switching temperature
(large screw)

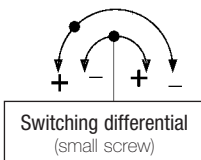

Switching differential
(small screw)

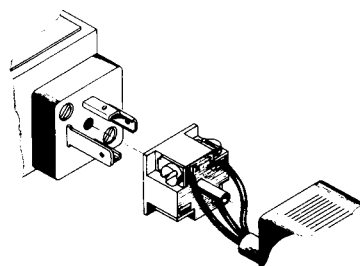

Adjustment of thermostats at lower switching point

Setpoint x^s corresponds to the lower switching point (with falling temperature), the upper switching point x^o (with rising temperature) is higher by the amount of the switching differential x^d .

Setting the switching temperature (setpoint adjustment)

Prior to adjustment, the setscrew above the scale must be loosened by approx. 2 turns and retightened after setting.

The switching temperature is set via the spindle. The set switching temperature is shown by the scale.

In view of tolerances and variations in the characteristics of sensors and springs, and due to friction in the switching kinematics, slight discrepancies between the setting value and the switching point are unavoidable. The thermostats are usually calibrated in such a way that the setpoint adjustment and the actual switching temperature correspond as closely as possible in the middle of the range. Possible deviations spread to both sides equally.

Clockwise: low switching temperature

Anticlockwise: high switching temperature

Changing the switching differential (only for switching device TRMV...)

The switching differential is changed by turning the setscrew within the spindle. The lower switching point is not changed by the differential adjustment; only the upper switching point is shifted by the differential. One turn of the differential screw changes the switching differential by about 1/2 of the total differential range.

When adjusting please note:

Switching temperature: Clockwise for lower switching point.

Anticlockwise for higher switching point.

Switching differential: Clockwise for larger differential. Anticlockwise for smaller differential.

Electrical connection

Plug connection to DIN EN175301. Cable entry Pg 11, max. cable diameter 10 mm.

Cable outlet possible in 4 directions spaced 90° apart.

Temperature limiter with reclosing lockout

Additional function ZFT205 and ZFT206: All thermostats can be equipped with a mechanical interlock. On reaching the value set on the scale, the microswitch trips over and remains in this position.

The lock can be released by pressing the unlocking button (identified by a red dot on the scale side of the switching device). The interlock can take effect with rising or falling temperature, depending on the version.

Mounting position

A vertical mounting position is preferable if at all possible. IP 54 protection is guaranteed with a vertical mounting position. A different mounting position may alter the protection class, but the operation of the thermostat is not affected.

Outdoor installation of thermostats

FEMA thermostats can be installed out of doors provided they are mounted vertically and suitably protected against the direct effects of weather. At ambient temperatures below 0°C, ensure that condensation cannot occur in the sensor or in the switching device.

Mechanical thermostats

Principal technical data

Standard version



...200

Terminal connection

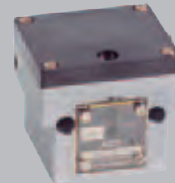

...300

Switch housing
Switching function
and connection scheme
 (applies only to version with microswitch)

Diecast aluminium GDAISI 12
 Floating changeover contact
 With rising pressure
 single pole switching from 3-1 to 3-2

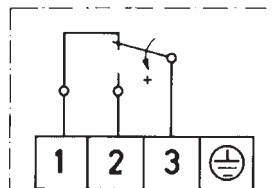

Diecast aluminium GDAISI 12
 Floating changeover contact.
 With rising pressure
 single pole switching from 3-1 to 3-2

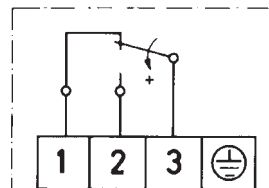

Switching capacity
 (applies only to version with microswitch)

8 A at 250 VAC
 5 A at 250 VAC inductive
 8 A at 24 VDC
 0.3 A at 250 VDC
 min. 10 mA, 12 VDC
 Vertical or horizontal,
 preferably vertical

8 A at 250 VAC
 5 A at 250 VAC inductive
 8 A at 24 VDC
 0.3 A at 250 VDC
 min. 10 mA, 12 VDC
 Vertical

Mounting position

Protection class
 (in vertical position)

IP 54

IP 65

Electrical connection

Plug connection to DIN EN175301

Terminal connection

Cable entry
Ambient temperature
Switching point

Pg 11
 -15 to +70 °C
 Adjustable with spindle

M 16 x 1.5
 -15 to +70 °C
 Adjustable with spindle after
 the terminal box cover is removed
 Not adjustable

Switching differential

Adjustable or not adjustable
 (see Product Summary)

Max. 70 °C, briefly 85 °C

Medium temperature
Vibration strength

No significant deviations up to 4 g.
 At higher accelerations, the switching differential is reduced slightly.
 Use over 25 g is not permitted.

Isolation values

Overvoltage category III, contamination class 3, reference surge voltage 4000 V.
 Conformity to DIN VDE 0110 is confirmed.

Sensor systems

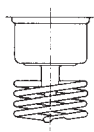

Room sensor TRM

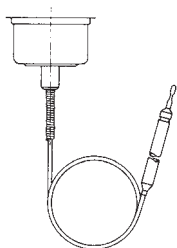

Capillary tube sensor TAM

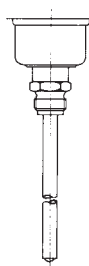

Rod sensor TX+R10

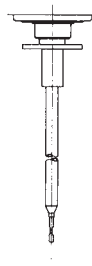

Air duct sensor TX+R6

Mechanical thermostats

Principal technical data



Switch housing
Switching function and connection scheme
(applies only to version with microswitch)

Diecast aluminium GDAISI 12
Floating changeover contact
With rising pressure
single pole switching from 3-1 to 3-2

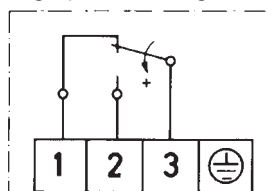

Switching capacity
(applies only to version with microswitch)

max. 100 mA, 24 VDC
min. 2 mA, 24 VDC

Mounting position

Vertical or horizontal,
vertically upright
IP 65

Protection class
(in vertical position)

Explosion protection
with immersion well

Ex II 1/2G Ex ia IIC T6 Ga/Gb
Ex II 1/2D Ex ia IIIC T80 °C

Electrical connection

Terminal connection

Cable entry
Ambient temperature
Switching point

M 16 x 1.5
-15 to +60 °C
Adjustable with spindle after
the terminal box cover is removed

Switching differential
Medium temperature
Vibration strength

not adjustable
Max. 60 °C
No significant deviations up to 4 g.
At higher accelerations, the switching differential is reduced slightly.
Use over 25 g is not permitted.

Isolation values

Overvoltage category III, contamination class 3, reference surge voltage 4000 V.
Conformity to DIN VDE 0110 is confirmed.

Sensor systems

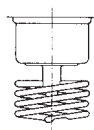

Room sensor TRM

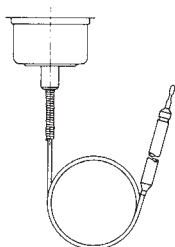

Capillary tube sensor TAM

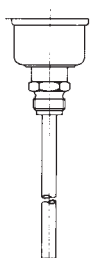

Rod sensor TX+R10

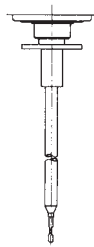

Air duct sensor TX+R6

Diecast aluminium GDAISI 12
Floating changeover contact.
With rising pressure
single pole switching from 3-1 to 3-2

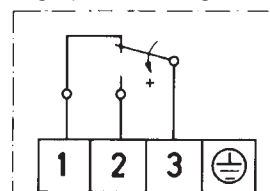

3 A at 250 VAC
2 A at 250 VAC inductive
3 A at 24 VDC
0.03 A at 250 VDC
min. 2 mA, 24 VDC
Vertically upright

IP 65

CE 0035 Ex II 2G Ex d e IIC T6 Gb
CE 0035 Ex II 1/2D Ex ta/tb IIIC T80 °C Da/Db

Exception: EX-TRM...:

Ex II 2G Ex d e IIC T6 Gb
Ex II 2D Ex tb IIIC T80 °C Db

Terminal connection

M 16 x 1.5
-20 to +60 °C
Adjustable with spindle after
the terminal box cover is removed

Not adjustable
Max. 60 °C

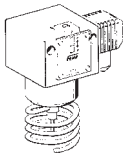
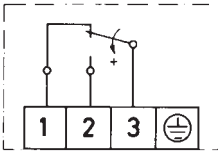
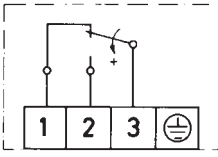
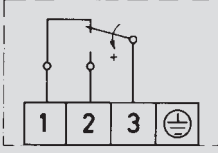
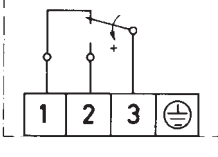
Plug connection 200 series	Description	Connection scheme
	Standard version Microswitch, single pole switching	
ZFT213	Gold-plated contacts with low contact resistance (e. g. for low voltage) Adjustable switching diff. is not available	
ZFT301	Terminal connection housing (IP 65)	
ZFT351	Protection class IP 65 and switch housing with surface protection (terminal connection housing)	
ZFT513	Ex-i-version 500 housing, blue cable entry and terminal connection Gold-plated contacts, protection class IP 65 ATEX-Approval: please see page 10–13	
	Power supply circuit: U _i 24 V DC I _i 100 mA C _i 1 nF L _i 100 µH	

* Additional prices are to be added to the standard equipment prices in each case.

For devices which differ from the standard equipment, the code of the switching device is part of the type designation.

** Switching point adjustment: Please specify switching point and direction of action (rising or falling temperature).

Example for ordering:

TX150-513

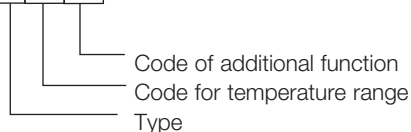

Service functions

Devices with service functions will be produced individually according to the customer's specifications. The system requires that these product combinations be identified in such a way as to prevent any possibility of confusion. These combinations are characterised by a product code with the suffix "-S" on the packaging label as well as separate labels with barcodes for each service function.

Service functions

ZFT5970	Setting of switching point according to customer's instructions
ZFT5971	Setting of switching points according to customer's instructions with lead sealing
ZFT1978	Labelling of units according to customer's instructions with sticker Test certificates according to EN 10 204
WZ2.2	Factory certificate 2.2 based on non-specific specimen test
AZ3.1B1	Acceptance test certificate 3.1 based on specific test

** **Switching point adjustment:** Please specify **switching point and direction of action** (rising or falling pressure).

Service functions are available for the following type series (including Ex-versions):

Thermostats: TAM, TX, TRM,

Ordering devices with service functions: See page 33.

Mouser Electronics

Authorized Distributor

Click to View Pricing, Inventory, Delivery & Lifecycle Information:

Honeywell:

[TAM490](#) [TAM150-301](#) [TAM150-305](#) [TAM150-351](#) [TAM490-205](#) [TAM813](#) [TAM813-563](#) [TAM022-513](#) [TAM022-351](#) [TAM150-213](#) [TAM813-205](#) [TAM022](#) [TAM490-351](#) [TAM490-305](#) [TAM490-301](#) [TAM490-213](#) [TAM022-206](#) [TAM490-513](#) [TAM150](#) [TAM022-301](#) [TAM813-313](#) [TAM022-306](#) [TAM813-351](#) [TAM813-513](#) [TAM813-305](#) [TAM813-301](#) [TAM150-513](#) [TAM150-205](#) [TAM150-206](#)