

HBT DIGITAL PHASE-FREQUENCY DETECTOR, 10 - 1300 MHz



Typical Applications

This Phase Frequency Detector is a key component in low phase noise frequency synthesis applications such as:

- Point-to-Point Radios
- Satellite Communication Systems
- Military Applications
- Sonet Clock Generation

Functional Diagram



Features

- Ultra Low SSB Phase Noise Floor:
 - 153 dBc/Hz @ 10 kHz offset @ 100 MHz
- Input up to 1300 MHz Fin.
- Differential Input/Single Ended Output
- Open Collector Output Buffer Amplifiers
- QSOP16G SMT Package: 29.4 mm²

General Description

The HMC439QS16G & HMC439QS16GE are digital phase-frequency detectors intended for use in low noise phase-locked loop applications for inputs from 10 to 1300 MHz. Its combination of high frequency of operation along with its ultra low phase noise floor make possible synthesizers with wide loop bandwidth and low N resulting in fast switching and very low phase noise. When used in conjunction with a differential loop amplifier, the HMC439QS16G & HMC439QS16GE generate output voltages that can be used to phase lock a VCO to a reference oscillator. The device is packaged in a low cost, surface mount 16 lead QSOP package with an exposed base for improved RF and thermal performance.

Electrical Specifications, $T_A = +25^\circ C$, $V_{CC} = 5V$

Parameter	Conditions	Min.	Typ.	Max.	Units
Maximum Input Frequency		1300			MHz
Minimum Input Frequency	Sine Wave Input			10	MHz
Input Power Range	Fin= 10 to 1300 MHz	-10		+10	dBm
Output Voltage			2000		mV, Pk - Pk
SSB Phase Noise	@ 10 kHz Offset with 100 MHz Input & Pin= 0 dBm		-153		dBc/Hz
Supply Current (Icc)			96		mA



**HBT DIGITAL PHASE-FREQUENCY
DETECTOR, 10 - 1300 MHz**

Error Voltage vs. Frequency, Pin= 0 dBm*

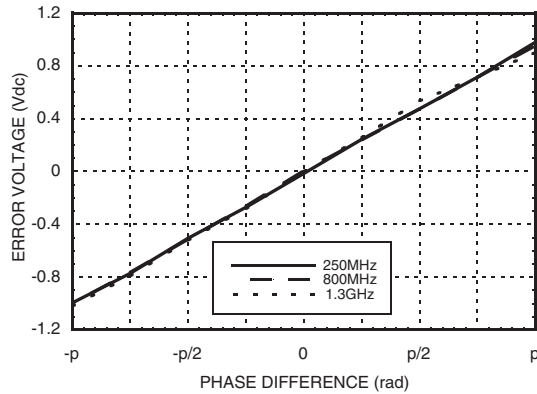

**Error Voltage vs. Supply Voltage,
Pin= 0 dBm, Fin= 250 MHz***

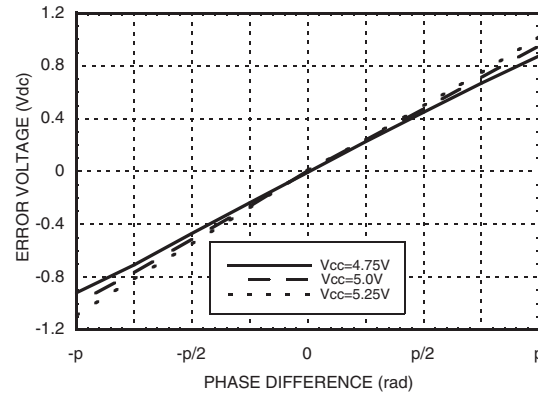

**Error Voltage vs. Temperature,
Pin= 0 dBm, Fin= 250 MHz***

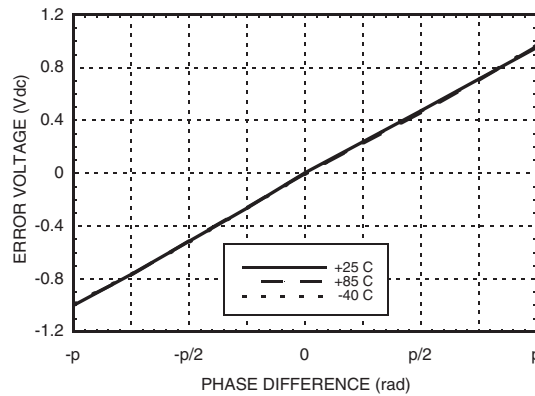

**SSB Phase Noise Performance,
Pin= 0 dBm, T= 25 °C**

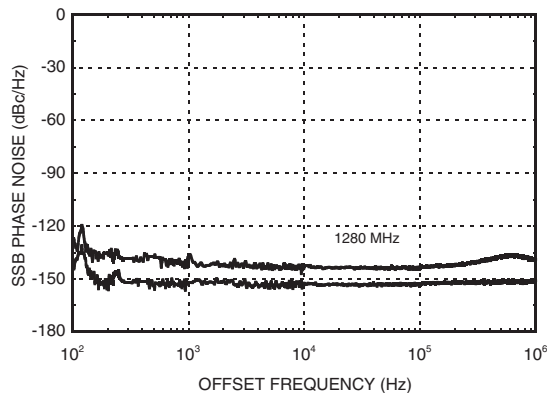

**SSB Phase Noise Performance,
Pin= 0 dBm, Fin= 100 MHz**

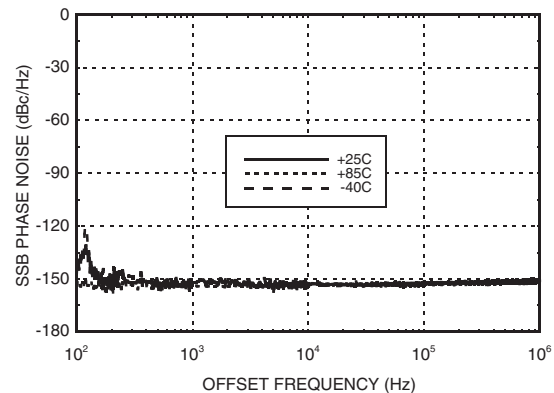

* See Gain & Error Voltage Test Circuit herein.

Information furnished by Analog Devices is believed to be accurate and reliable. However, no responsibility is assumed by Analog Devices for its use, nor for any infringements of patents or other rights of third parties that may result from its use. Specifications subject to change without notice. No license is granted by implication or otherwise under any patent or patent rights of Analog Devices. Trademarks and registered trademarks are the property of their respective owners.

For price, delivery, and to place orders: Analog Devices, Inc., One Technology Way, P.O. Box 9106, Norwood, MA 02062-9106 Phone: 781-329-4700 • Order online at www.analog.com Application Support: Phone: 1-800-ANALOG-D



HBT DIGITAL PHASE-FREQUENCY DETECTOR, 10 - 1300 MHz

Absolute Maximum Ratings

RF Input (Vcc= +5V)	+13 dBm
Supply Voltage (Vcc)	+5.5V
Channel Temperature (Tc)	135 °C
Continuous Pdiss (T = 85 °C) (derate 47.2 mW/° C above 85 °C)	4.25 W
Storage Temperature	-65 to +150 °C
Operating Temperature	-40 to +85 °C



**ELECTROSTATIC SENSITIVE DEVICE
OBSERVE HANDLING PRECAUTIONS**

Typical Supply Current vs. Vcc

Vcc (Vdc)	Icc (mA)
4.8	90
5.0	96
5.2	102

Note: Detector will work over full voltage range above.

Typical DC Characteristics @ Vcc = +5V

Symbol	Characteristics	+25C			Units
		Min.	Typ.	Max.	
Icc	Power Supply Current	90	96	102	mA
Voh	Output High Voltage	5.0	5.0	5.0	V
Vol	Output Low Voltage	2.9	3	3.1	V

Outline Drawing



- NOTES:
- LEADFRAME MATERIAL: COPPER ALLOY
 - DIMENSIONS ARE IN INCHES [MILLIMETERS]
 - DIMENSION DOES NOT INCLUDE MOLDFLASH OF 0.15mm PER SIDE.
 - DIMENSION DOES NOT INCLUDE MOLDFLASH OF 0.25mm PER SIDE.
 - ALL GROUND LEADS AND GROUND PADDLE MUST BE SOLDERED TO PCB RF GROUND.

Package Information

Part Number	Package Body Material	Lead Finish	MSL Rating	Package Marking ^[3]
HMC439QS16G	Low Stress Injection Molding Plastic	Sn/Pb Solder	MSL1 ^[1]	H439 XXXX
HMC439QS16GE	RoHS-compliant Low Stress Injection Molding Plastic	100% matte Sn	MSL1 ^[2]	H439 XXXX

[1] Max peak reflow temperature of 235 °C
 [2] Max peak reflow temperature of 260 °C
 [3] 4-Digit lot number XXXX

HBT DIGITAL PHASE-FREQUENCY DETECTOR, 10 - 1300 MHz



Pin Description

Pin Number	Function	Description	Interface Schematic
1	Vcc	Supply voltage 5V ± 0.2V	
2, 8, 9, 11, 16	GND	All ground leads and ground paddle must be connected to PCB RF/DC ground.	
3	REF	(These pins are AC coupled and must be DC blocked externally.) Reference Input	
4	NREF	Reference Input Compliment	
5	N/C	Not Connected	
6	VCO	(These pins are AC coupled and must be DC blocked externally.) VCO Input	
7	NVCO	VCO Input Compliment	
10	Vcc3V	3.0 Volt Reference Voltage for Internal 10mA Current Source	
12	ND	Down Output Compliment	
13	D		
14	NU	Up Output Compliment	
15	U		

Information furnished by Analog Devices is believed to be accurate and reliable. However, no responsibility is assumed by Analog Devices for its use, nor for any infringements of patents or other rights of third parties that may result from its use. Specifications subject to change without notice. No license is granted by implication or otherwise under any patent or patent rights of Analog Devices. Trademarks and registered trademarks are the property of their respective owners.

For price, delivery, and to place orders: Analog Devices, Inc., One Technology Way, P.O. Box 9106, Norwood, MA 02062-9106
Phone: 781-329-4700 • Order online at www.analog.com
Application Support: Phone: 1-800-ANALOG-D



**HBT DIGITAL PHASE-FREQUENCY
DETECTOR, 10 - 1300 MHz**

Gain & Error Voltage Test Circuit:

Gain & Error Voltage data taken using test circuit below. Loop filter gain has been subtracted from the result.

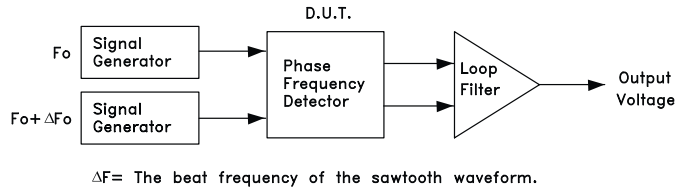

Typical PLL Application Circuit using HMC439QS16G

PLL application shown for a 12.8 GHz Fout. Contact HMC to discuss your specific application.



Information furnished by Analog Devices is believed to be accurate and reliable. However, no responsibility is assumed by Analog Devices for its use, nor for any infringements of patents or other rights of third parties that may result from its use. Specifications subject to change without notice. No license is granted by implication or otherwise under any patent or patent rights of Analog Devices. Trademarks and registered trademarks are the property of their respective owners.

For price, delivery, and to place orders: Analog Devices, Inc., One Technology Way, P.O. Box 9106, Norwood, MA 02062-9106 Phone: 781-329-4700 • Order online at www.analog.com Application Support: Phone: 1-800-ANALOG-D



Evaluation PCB

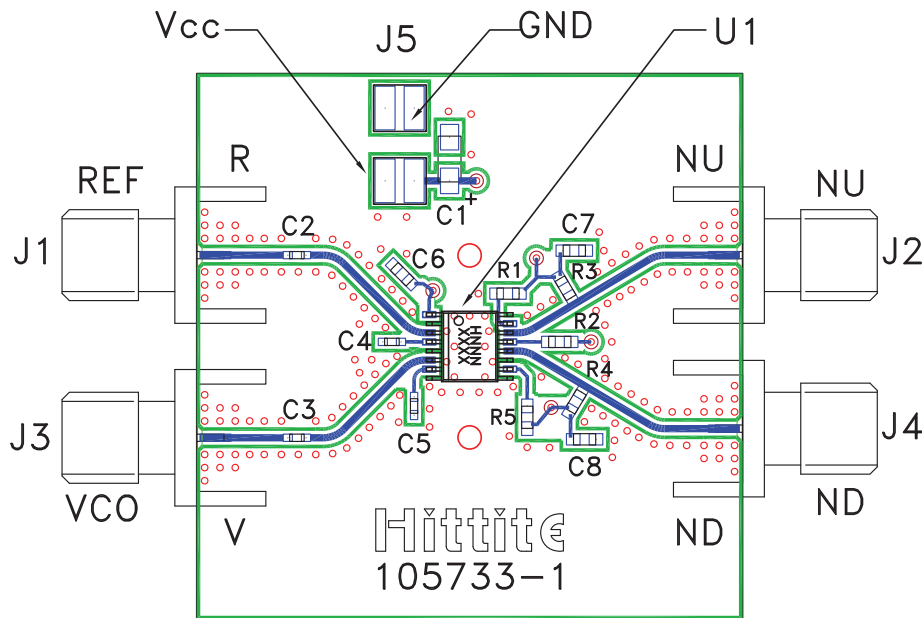

The circuit board used in the final application should use RF circuit design techniques. Signal lines should have 50 ohm impedance while the package ground leads and backside ground slug should be connected directly to the ground plane similar to that shown. A sufficient number of via holes should be used to connect the top and bottom ground planes. The evaluation circuit board shown is available from Hittite upon request.

**List of Materials for
Evaluation PCB 105809 [1]**

Item	Description
J1 - J4	PCB Mount SMA RF Connector
J5	2 mm DC Header
C1	4.7 μ F Capacitor
C2, C5 - C7	100 pF Capacitor, 0402 Pkg.
C3, C4, C8	1000 pF Capacitor, 0603 Pkg.
R1 ^[3] , R2 ^[3]	4.3 Ohm Resistor, 0603 Pkg.
R3, R4, R5	200 Ohm Resistor, 0603 Pkg.
U1	HMC439QS16G / HMC439QS16GE
PCB ^[2]	105733 Eval Board

[1] Reference this number when ordering complete evaluation PCB

[2] Circuit Board Material: Rogers 4350

[3] Choose values of R1 & R2 between 4.3 and 20 Ohms for best noise performance

Evaluation PCB Circuit

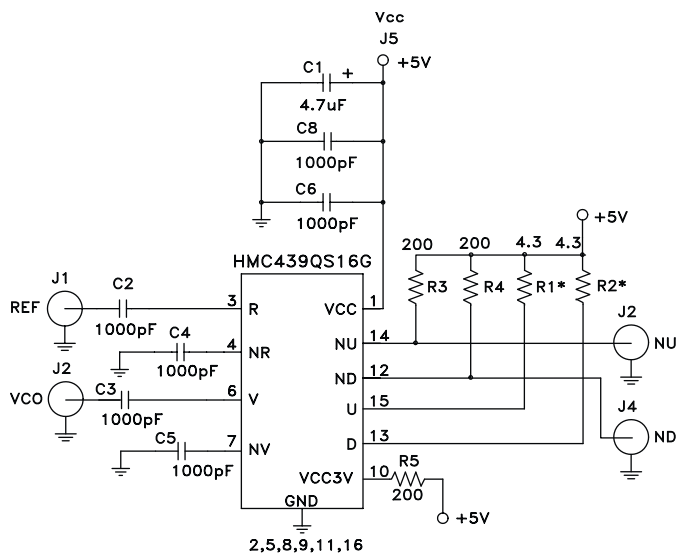

Information furnished by Analog Devices is believed to be accurate and reliable. However, no responsibility is assumed by Analog Devices for its use, nor for any infringements of patents or other rights of third parties that may result from its use. Specifications subject to change without notice. No license is granted by implication or otherwise under any patent or patent rights of Analog Devices. Trademarks and registered trademarks are the property of their respective owners.

For price, delivery, and to place orders: Analog Devices, Inc., One Technology Way, P.O. Box 9106, Norwood, MA 02062-9106 Phone: 781-329-4700 • Order online at www.analog.com Application Support: Phone: 1-800-ANALOG-D