



Bidirectional TVSarray

DESCRIPTION

This USB50403C – USB50424C Transient Voltage Suppressor (TVS) family is packaged in a SOT-143 configuration giving protection to 1 bidirectional data or interface line. It is designed for use in applications where protection is required at the board level from voltage transients caused by electrostatic discharge (ESD) as defined in IEC 61000-4-2, electrical fast transients (EFT) per IEC 61000-4-4 and secondary effects of lightning. It is also available in RoHS compliant versions.

These TVS arrays have a peak power rating of 500 watts for an 8/20 μ sec pulse. This array is suitable for protection of sensitive circuitry consisting of TTL, CMOS, DRAM's, SRAM's, HCMOS, HSIC microprocessors, and Universal Serial Bus (USB) and I/O transceivers.

Important: For the latest information, visit our website <http://www.microsemi.com>.

FEATURES

- Protects 1 bidirectional line.
- Surge protection per IEC 61000-4-2 and IEC 61000-4-4.
- Provides electrically isolated protection.
- UL 94V-0 flammability classification.
- Ultra low capacitance, 3 pF per line pair.
- Ultra low leakage.
- RoHS compliant versions available.

APPLICATIONS / BENEFITS

- EIA-RS485 data rates: 5 Mbs
- 10 Base T Ethernet.
- USB data rate: 900 Mbs

MAXIMUM RATINGS

Parameters/Test Conditions	Symbol	Value	Unit
Junction and Storage Temperature	T_J and T_{STG}	-55 to +150	$^{\circ}C$
Peak Pulse Power @ 8/20 μ s (see Figure 1)	P_{PP}	500	W
Impulse Repetition Rate	df	< .01	%
Total Capacitance (f = 1 MHz) @ 0 V	C_T	3	pF
Solder Temperature @ 10 s		260	$^{\circ}C$

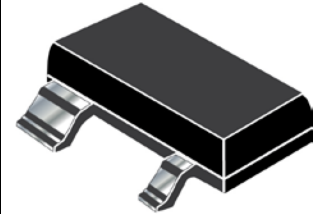

SOT-143 Package

Also available in:

Unidirectional SOT-143
(surface mount)
 [USB50403 – USB50424](#)

MSC – Lawrence

6 Lake Street,
Lawrence, MA 01841
Tel: 1-800-446-1158 or
(978) 620-2600
Fax: (978) 689-0803

MSC – Ireland

Gort Road Business Park,
Ennis, Co. Clare, Ireland
Tel: +353 (0) 65 6840044
Fax: +353 (0) 65 6822298

Website:

www.microsemi.com

MECHANICAL and PACKAGING

- CASE: Molded SOT-143 surface mount
- TERMINALS: Tin-lead or RoHS compliant annealed matte-tin plating
- MARKING: See electrical characteristics table
- POLARITY: Pin #1 (Please refer to [Schematic and Pad Layout](#) for pin 1.)
- TAPE & REEL option: Per EIA standard 481-1-A. Consult factory for quantities
- WEIGHT: Approximately 0.035 grams
- See [Package Dimensions](#) on last page.

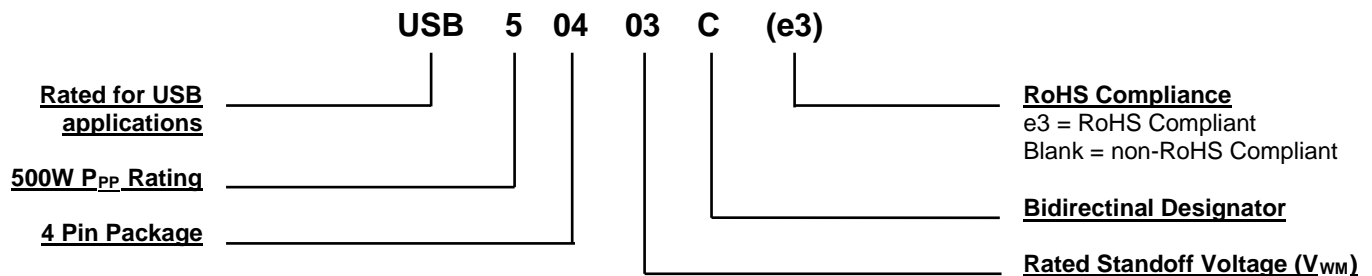
PART NOMENCLATURE

SYMBOLS & DEFINITIONS

Symbol	Definition
$\alpha_{V(BR)}$	Temperature Coefficient of Breakdown Voltage: The change in breakdown voltage divided by the change in temperature that caused it expressed in %/°C or mV/°C.
C _T	Total Capacitance: The total small signal capacitance between the diode terminals of a complete device.
I _D	Standby Current: The current through the device at rated stand-off voltage.
V _(BR)	Breakdown Voltage: The voltage across the device at a specified current I _(BR) in the breakdown region.
V _C	Clamping Voltage: The voltage across the device in a region of low differential resistance during the application of an impulse current (I _{PP}) for a specified waveform.
V _{WM}	Working Standoff Voltage: The maximum-rated value of dc or repetitive peak positive cathode-to-anode voltage that may be continuously applied over the standard operating temperature.

ELECTRICAL CHARACTERISTICS

PART NUMBER	DEVICE MARKING*	STAND-OFF VOLTAGE	BREAKDOWN VOLTAGE	CLAMPING VOLTAGE	CLAMPING VOLTAGE	STANDBY CURRENT	TOTAL CAPACITANCE	TEMPERATURE COEFFICIENT
		V _{WM}	V _(BR) @1 mA	V _C @ 1 Amp (Figure 2)	V _C @ 5 Amp (Figure 2)	I _D @ V _{WM}	(f= 1 MHz) C _T @ 0 V pF	OF V _(BR) α _{V(BR)}
		Volts	Volts	Volts	Volts	µA		mV/°C
		MAX	MIN	MAX	MAX	MAX	MAX	MAX
USB50403C	53	3.3	4	8	11	200	3	-5
USB50405C	55	5.0	6.0	10.8	13	40	3	1
USB50412C	512	12.0	13.3	19	26	1	3	8
USB50415C	515	15.0	16.7	24	32	1	3	11
USB50424C	524	24.0	26.7	43	57	1	3	28

* Device marking has a dot suffix for the e# RoHS compliant option (e.g. 53●, 512●, etc.)

GRAPHS

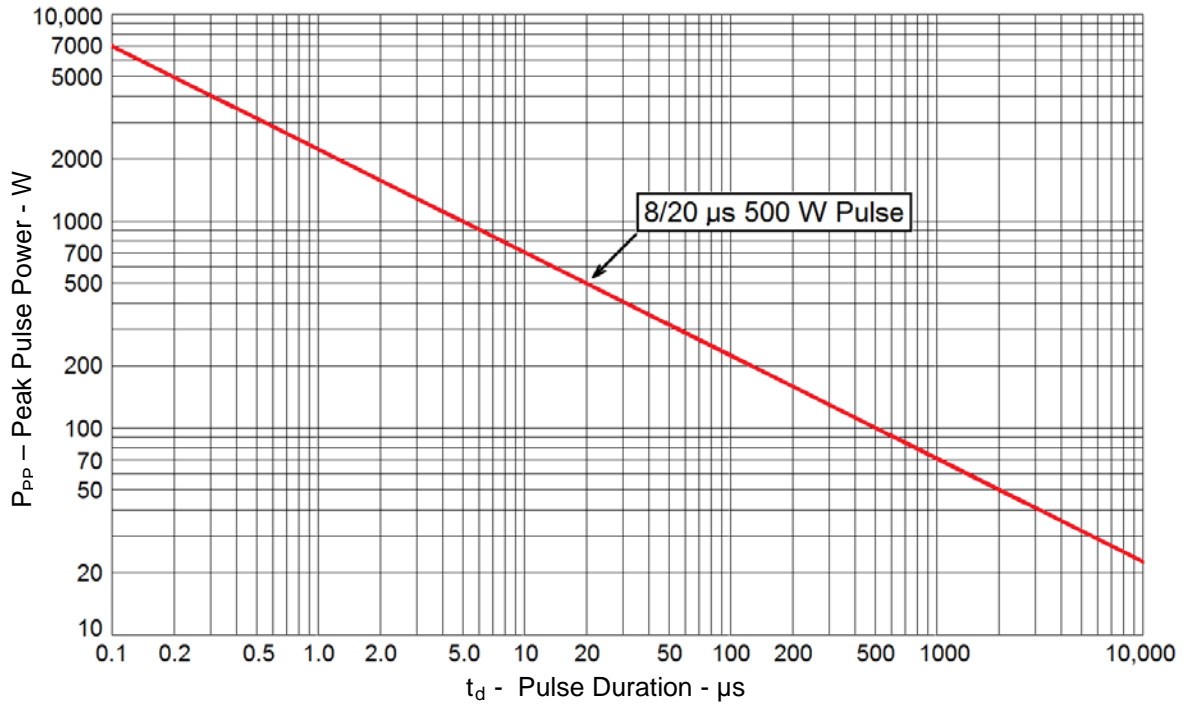

FIGURE 1
Peak Pulse Power vs Pulse Time

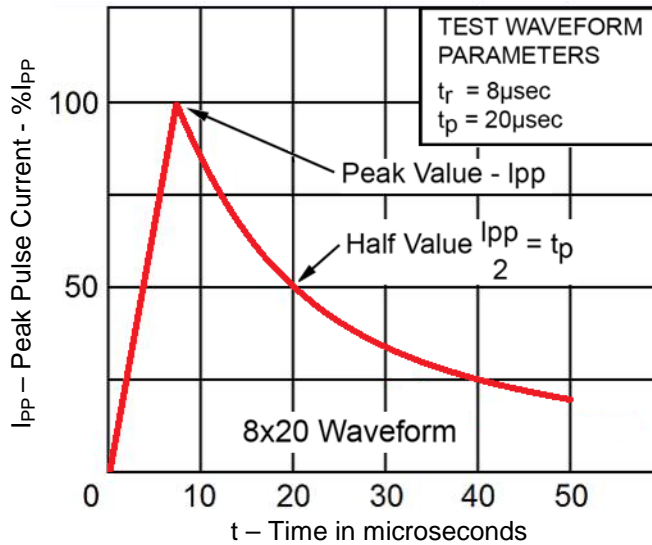
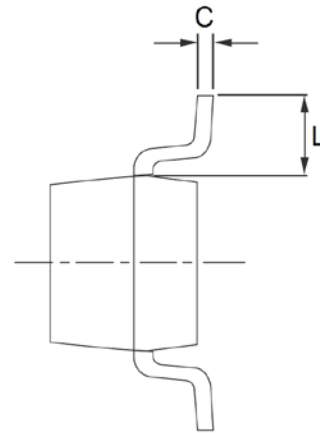
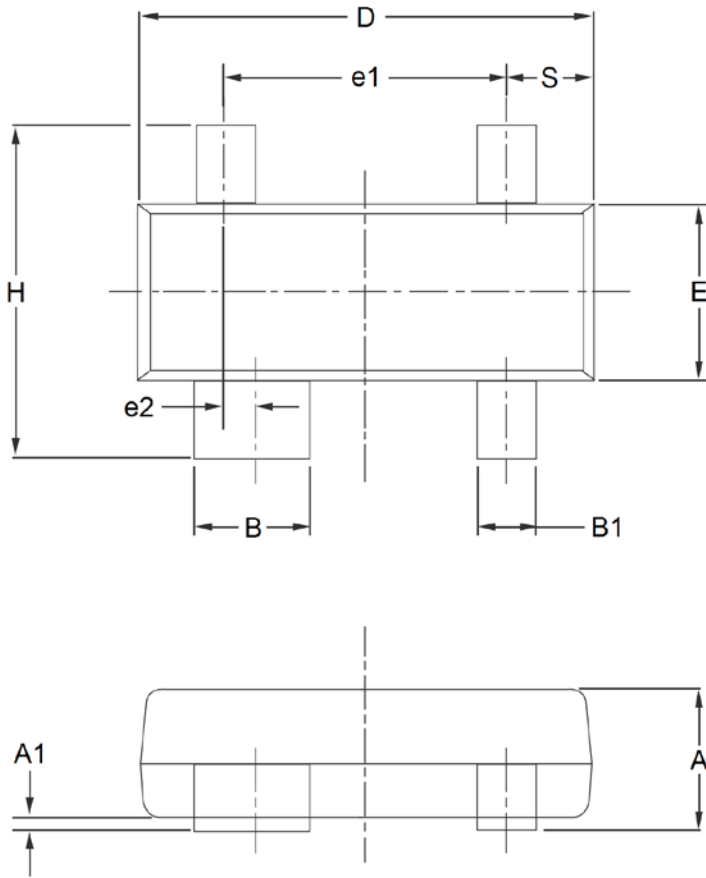
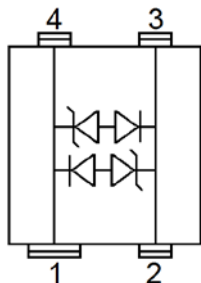

FIGURE 2
Pulse Waveform

PACKAGE DIMENSIONS

Ltr	Dimensions			
	Inch		Millimeters	
	Min	Max	Min	Max
A	0.890	1.120	22.61	28.45
A1	0.013	0.100	0.330	2.54
B	0.760	0.940	19.30	23.88
B1	0.370	0.510	9.40	12.95
C	0.085	0.180	2.16	4.57
D	2.800	3.040	71.12	77.22
E	1.200	1.400	30.48	35.56
e1	1.920 BSC		48.26 BSC	
e2	0.200 BSC		5.08 BSC	
H	2.100	2.640	53.34	67.06
L	0.55 REF		13.97 REF	
S	0.450	0.600	11.43	15.24

SCHEMATIC AND PAD LAYOUT

Schematic

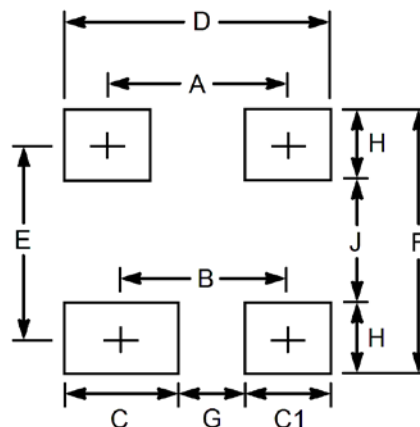

Ltr	Dimensions	
	Inch	Millimeters
	Typ	Typ
A	0.079	2.00
B	0.071	1.80
C	0.047	1.20
C1	0.033	0.85
D	0.112	2.85
E	0.075	1.90
F	0.108	2.75
G	0.310	0.80
H	0.033	0.85
J	0.041	1.05