

FEATURES

- RF frequency range of 2300 MHz to 2900 MHz
- IF frequency range of dc to 450 MHz
- Power conversion loss: 7.7 dB
- SSB noise figure of 7.6 dB
- Input IP3 of 31 dBm
- Typical LO drive of 0 dBm
- Single-ended, 50 Ω RF and LO input ports
- High isolation SPDT LO input switch
- Single-supply operation: 3.3 V to 5 V
- Exposed pad, 5 mm × 5 mm 20-lead LFCSP
- 1500 V HBM/1250 V FICDM ESD performance

APPLICATIONS

- Cellular base station receivers
- Transmit observation receivers
- Radio link downconverters

GENERAL DESCRIPTION

The ADL5363 uses a highly linear, doubly balanced passive mixer core along with integrated RF and local oscillator (LO) balancing circuitry to allow for single-ended operation. The ADL5363 incorporates an RF balun to provide optimal performance over a 2300 MHz to 2900 MHz input frequency range. The balanced passive mixer arrangement provides good LO-to-RF leakage, typically better than -30 dBm, and excellent intermodulation performance. The balanced mixer core also provides extremely high input linearity, allowing the device to be used in demanding cellular applications where in-band blocking signals might otherwise result in the degradation of dynamic performance.

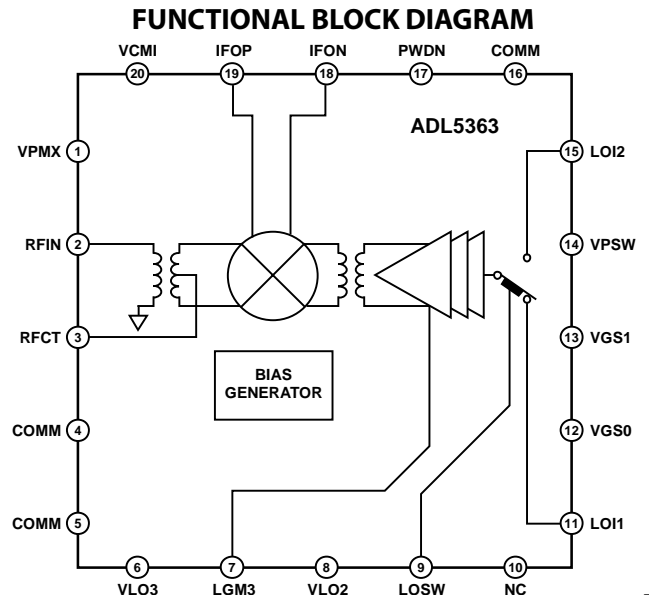

NC = NO CONNECT

Figure 1.

The ADL5363 provides two switched LO paths that can be used in TDD applications where it is desirable to rapidly switch between two local oscillators. LO current can be externally set using a resistor to minimize dc current commensurate with the desired level of performance. For low voltage applications, the ADL5363 is capable of operation at voltages down to 3.3 V with substantially reduced current. For low voltage operation, an additional logic pin is provided to power down (<200 μA) the circuit when desired.

The ADL5363 is fabricated using a BiCMOS high performance IC process. The device is available in a 5 mm × 5 mm, 20-lead LFCSP and operates over a -40°C to +85°C temperature range. An evaluation board is also available.

Table 1. Passive Mixers

| RF Frequency (MHz) | Single Mixer | Single Mixer and IF Amp | Dual Mixer and IF Amp |
|--------------------|--------------|-------------------------|-----------------------|
| 500 to 1700 | ADL5367 | ADL5357 | ADL5358 |
| 1200 to 2500 | ADL5365 | ADL5355 | ADL5356 |
| 2300 to 2900 | ADL5363 | ADL5353 | ADL5354 |

TABLE OF CONTENTS

| | | | |
|--|---|--------------------------------|----|
| Features | 1 | 3.3 V Performance..... | 14 |
| Applications..... | 1 | Upconversion | 15 |
| General Description | 1 | Spurious Performance | 16 |
| Functional Block Diagram | 1 | Circuit Description..... | 17 |
| Revision History | 2 | RF Subsystem | 17 |
| Specifications..... | 3 | LO Subsystem | 18 |
| 5 V Performance | 4 | Applications Information | 19 |
| 3.3 V Performance..... | 4 | Basic Connections..... | 19 |
| Absolute Maximum Ratings..... | 5 | IF Port | 19 |
| ESD Caution..... | 5 | Mixer VGS Control DAC | 19 |
| Pin Configuration and Function Descriptions..... | 6 | Evaluation Board | 20 |
| Typical Performance Characteristics | 7 | Outline Dimensions | 23 |
| 5 V Performance | 7 | Ordering Guide | 23 |

REVISION HISTORY

2/15—Rev. 0 to Rev. A

| | |
|--|----|
| Deleted Figure 37 and Figure 38..... | 13 |
| Deleted Bias Resistor Selection Section..... | 19 |
| Changes to Figure 48..... | 20 |
| Changes to Table 7..... | 21 |
| Updated Outline Dimensions | 23 |
| Changes to Ordering Guide | 23 |

7/10—Revision 0: Initial Version

SPECIFICATIONS

$V_S = 5\text{ V}$, $I_S = 100\text{ mA}$, $T_A = 25^\circ\text{C}$, $f_{RF} = 2535\text{ MHz}$, $f_{LO} = 2738\text{ MHz}$, LO power = 0 dBm, $Z_O = 50\ \Omega$, unless otherwise noted.

Table 2.

| Parameter | Test Conditions/Comments | Min | Typ | Max | Unit |
|--|---|------|----------|------|---------------|
| RF INPUT INTERFACE | | | | | |
| Return Loss | Tunable to >20 dB over a limited bandwidth | | 16 | | dB |
| Input Impedance | | | 50 | | Ω |
| RF Frequency Range | | 2300 | | 2900 | MHz |
| OUTPUT INTERFACE | | | | | |
| Output Impedance | Differential impedance, $f = 200\text{ MHz}$ | | 33 -0.3 | | Ω pF |
| IF Frequency Range | | dc | | 450 | MHz |
| DC Bias Voltage ¹ | Externally generated | 3.3 | 5.0 | 5.5 | V |
| LO INTERFACE | | | | | |
| LO Power | | -6 | 0 | +10 | dBm |
| Return Loss | | | 15 | | dB |
| Input Impedance | | | 50 | | Ω |
| LO Frequency Range | | 2330 | | 3350 | MHz |
| POWER-DOWN (PWDN) INTERFACE ² | | | | | |
| PWDN Threshold | | | 1.0 | | V |
| Logic 0 Level | | | | 0.4 | V |
| Logic 1 Level | | 1.4 | | | V |
| PWDN Response Time | Device enabled, IF output to 90% of its final level | | 160 | | ns |
| | Device disabled, supply current <5 mA | | 220 | | ns |
| PWDN Input Bias Current | Device enabled | | 0.0 | | μA |
| | Device disabled | | 70 | | μA |

¹ Apply the supply voltage from the external circuit through the choke inductors.

² The PWDN function is intended for use with $V_S \leq 3.6\text{ V}$ only.

5 V PERFORMANCE

$V_S = 5\text{ V}$, $I_S = 100\text{ mA}$, $T_A = 25^\circ\text{C}$, $f_{RF} = 2535\text{ MHz}$, $f_{LO} = 2738\text{ MHz}$, LO power = 0 dBm, VGS0 = VGS1 = 0 V, and $Z_O = 50\ \Omega$, unless otherwise noted.

Table 3.

| Parameter | Test Conditions/Comments | Min | Typ | Max | Unit |
|---|--|-----|-----|-----|------|
| DYNAMIC PERFORMANCE | | | | | |
| Power Conversion Loss | Including 1:1 IF port transformer and PCB loss | | 7.7 | | dB |
| SSB Noise Figure | | | 7.6 | | dB |
| Input Third-Order Intercept (IIP3) | $f_{RF1} = 2534.5\text{ MHz}$, $f_{RF2} = 2535.5\text{ MHz}$, $f_{LO} = 2738\text{ MHz}$, each RF tone at 0 dBm | | 31 | | dBm |
| Input Second-Order Intercept (IIP2) | $f_{RF1} = 2535\text{ MHz}$, $f_{RF2} = 2585\text{ MHz}$, $f_{LO} = 2738\text{ MHz}$, each RF tone at 0 dBm | | 62 | | dBm |
| Input 1 dB Compression Point (IP1dB) ¹ | Exceeding 20 dBm RF power results in damage to the device | | 25 | | dBm |
| LO-to-IF Leakage | Unfiltered IF output | | -22 | | dBm |
| LO-to-RF Leakage | | | -32 | | dBm |
| RF-to-IF Isolation | | | -44 | | dBc |
| IF/2 Spurious | -10 dBm input power | | -61 | | dBc |
| IF/3 Spurious | -10 dBm input power | | -70 | | dBc |
| POWER SUPPLY | | | | | |
| Positive Supply Voltage | | 4.5 | 5 | 5.5 | V |
| Quiescent Current | $V_S = 5\text{ V}$ | | 100 | | mA |

¹ Exceeding 20 dBm RF power results in damage to the device.

3.3 V PERFORMANCE

$V_S = 3.3\text{ V}$, $I_S = 60\text{ mA}$, $T_A = 25^\circ\text{C}$, $f_{RF} = 2535\text{ MHz}$, $f_{LO} = 2738\text{ MHz}$, LO power = 0 dBm, $R_9 = 226\ \Omega$, VGS0 = VGS1 = 0 V, and $Z_O = 50\ \Omega$, unless otherwise noted.

Table 4.

| Parameter | Test Conditions/Comments | Min | Typ | Max | Unit |
|-------------------------------------|--|-----|-----|-----|------|
| DYNAMIC PERFORMANCE | | | | | |
| Power Conversion Loss | Including 1:1 IF port transformer and PCB loss | | 7.4 | | dB |
| SSB Noise Figure | | | 6.8 | | dB |
| Input Third-Order Intercept (IIP3) | $f_{RF1} = 2534.5\text{ MHz}$, $f_{RF2} = 2535.5\text{ MHz}$, $f_{LO} = 2738\text{ MHz}$, each RF tone at 0 dBm | | 26 | | dBm |
| Input Second-Order Intercept (IIP2) | $f_{RF1} = 2535\text{ MHz}$, $f_{RF2} = 2585\text{ MHz}$, $f_{LO} = 2738\text{ MHz}$, each RF tone at 0 dBm | | 56 | | dBm |
| POWER SUPPLY | | | | | |
| Positive Supply Voltage | | | 3.3 | | V |
| Quiescent Current | $V_S = 5\text{ V}$ | | 60 | | mA |

ABSOLUTE MAXIMUM RATINGS

Table 5.

| Parameter | Rating |
|--------------------------------------|-----------------|
| Supply Voltage, V_S | 5.5 V |
| RF Input Level | 20 dBm |
| LO Input Level | 13 dBm |
| IFOP, IFON Bias Voltage | 6.0 V |
| VGS0, VGS1, LOSW, PWDN | 5.5 V |
| Internal Power Dissipation | 0.5 W |
| Thermal Resistance, θ_{JA} | 25°C/W |
| Temperature | |
| Maximum Junction Temperature | 150°C |
| Operating Temperature Range | -40°C to +85°C |
| Storage Temperature Range | -65°C to +150°C |
| Lead Temperature (Soldering, 60 sec) | 260°C |

Stresses at or above those listed under Absolute Maximum Ratings may cause permanent damage to the product. This is a stress rating only; functional operation of the product at these or any other conditions above those indicated in the operational section of this specification is not implied. Operation beyond the maximum operating conditions for extended periods may affect product reliability.

ESD CAUTION



ESD (electrostatic discharge) sensitive device. Charged devices and circuit boards can discharge without detection. Although this product features patented or proprietary protection circuitry, damage may occur on devices subjected to high energy ESD. Therefore, proper ESD precautions should be taken to avoid performance degradation or loss of functionality.

PIN CONFIGURATION AND FUNCTION DESCRIPTIONS

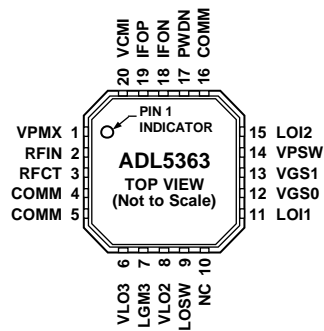

- NOTES
1. NC = NO CONNECT. DO NOT CONNECT TO THIS PIN.
 2. EXPOSED PAD. MUST BE SOLDERED TO GROUND.

09914-002

Figure 2. Pin Configuration

Table 6. Pin Function Descriptions

| Pin No. | Mnemonic | Description |
|----------|------------|---|
| 1 | VPMX | Positive Supply Voltage. |
| 2 | RFIN | RF Input. Must be ac-coupled. |
| 3 | RFCT | RF Balun Center Tap (AC Ground). |
| 4, 5, 16 | COMM | Device Common (DC Ground). |
| 6, 8 | VLO3, VLO2 | Positive Supply Voltages for LO Amplifier. |
| 7 | LGM3 | LO Amplifier Bias Control. |
| 9 | LOSW | LO Switch. LOI1 selected for 0 V, and LOI2 selected for 3 V. |
| 10 | NC | No Connect. |
| 11, 15 | LOI1, LOI2 | LO Inputs. Must be ac-coupled. |
| 12, 13 | VGS0, VGS1 | Mixer Gate Bias Controls. 3 V logic. Ground these pins for nominal setting. |
| 14 | VPSW | Positive Supply Voltage for LO Switch. |
| 17 | PWDN | Power Down. Connect this pin to ground for normal operation and connect this pin to 3.0 V for disable mode. |
| 18, 19 | IFON, IFOP | Differential IF Outputs. |
| 20 | VCMI | No Connect. This pin can be grounded. |
| | EPAD (EP) | Exposed pad. Must be soldered to ground. |

TYPICAL PERFORMANCE CHARACTERISTICS

5 V PERFORMANCE

$V_S = 5\text{ V}$, $I_S = 100\text{ mA}$, $T_A = 25^\circ\text{C}$, $f_{RF} = 2535\text{ MHz}$, $f_{LO} = 2738\text{ MHz}$, LO power = 0 dBm, $V_{GS0} = V_{GS1} = 0\text{ V}$, and $Z_O = 50\ \Omega$, unless otherwise noted.

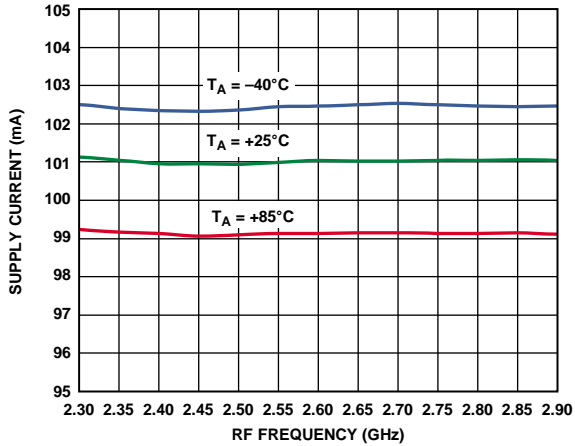

Figure 3. Supply Current vs. RF Frequency

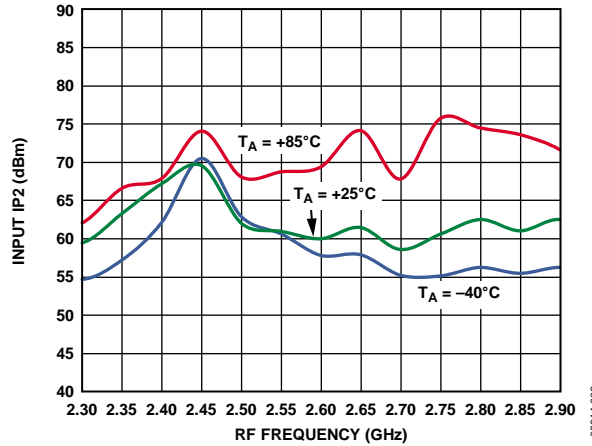

Figure 6. Input IP2 vs. RF Frequency

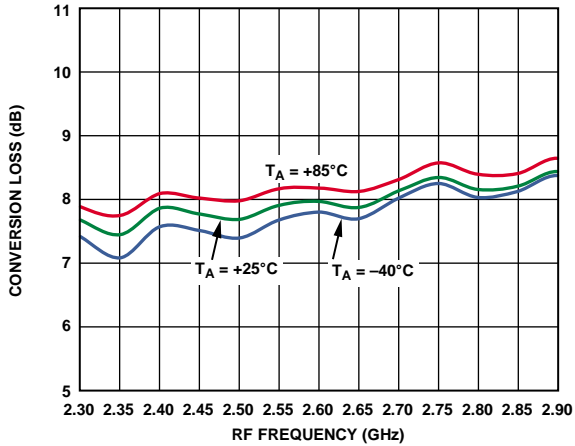

Figure 4. Power Conversion Loss vs. RF Frequency

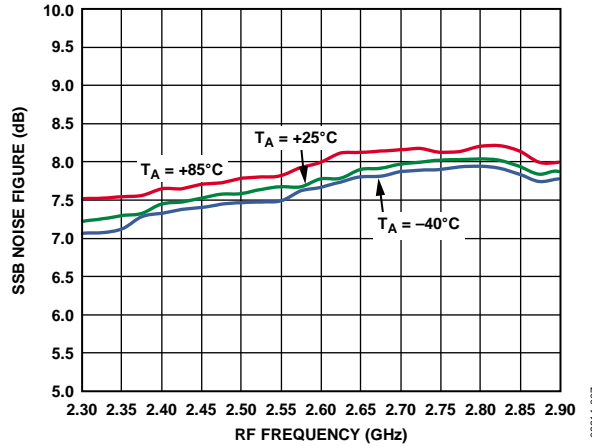

Figure 7. SSB Noise Figure vs. RF Frequency

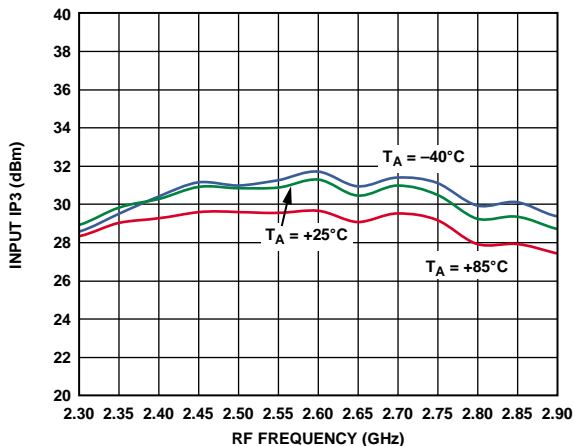

Figure 5. Input IP3 vs. RF Frequency

09914-003

09914-006

09914-004

09914-007

09914-005

$V_S = 5\text{ V}$, $I_S = 100\text{ mA}$, $T_A = 25^\circ\text{C}$, $f_{RF} = 2535\text{ MHz}$, $f_{LO} = 2738\text{ MHz}$, LO power = 0 dBm, $V_{GS0} = V_{GS1} = 0\text{ V}$, and $Z_O = 50\ \Omega$, unless otherwise noted.

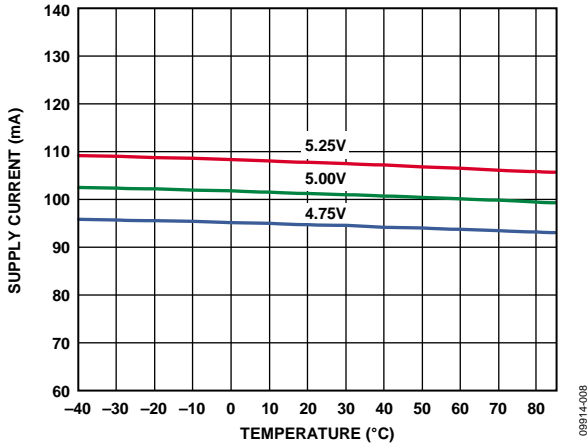

Figure 8. Supply Current vs. Temperature

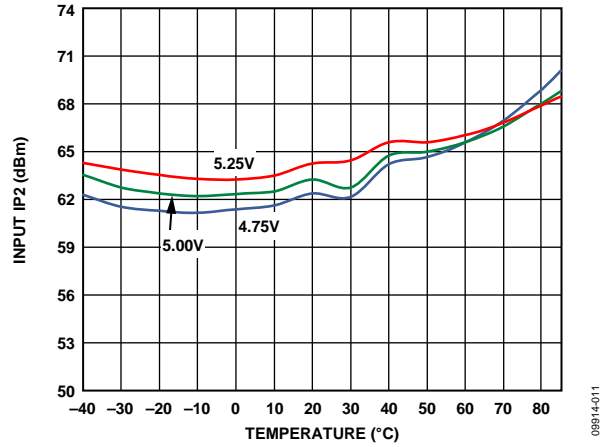

Figure 11. Input IP2 vs. Temperature

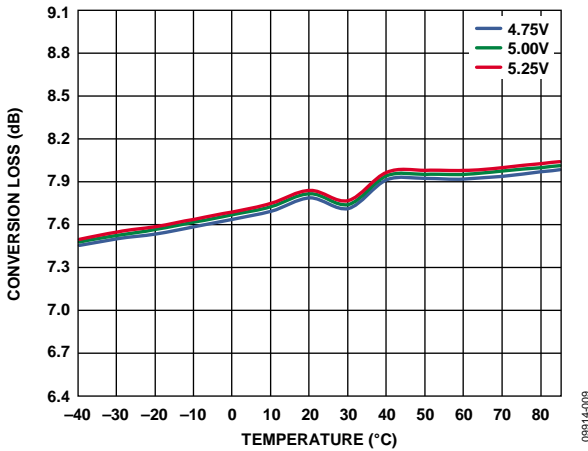

Figure 9. Power Conversion Loss vs. Temperature

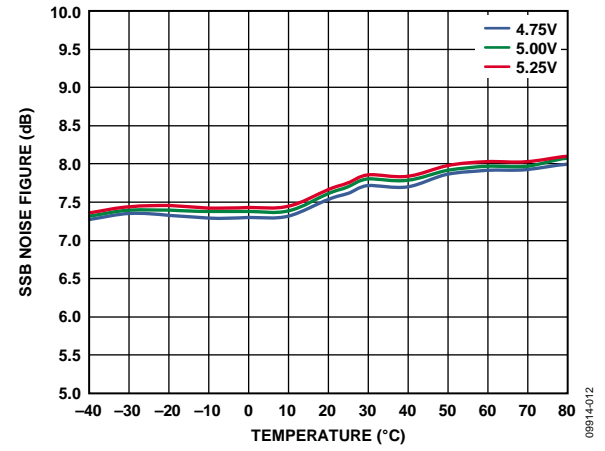

Figure 12. SSB Noise Figure vs. Temperature

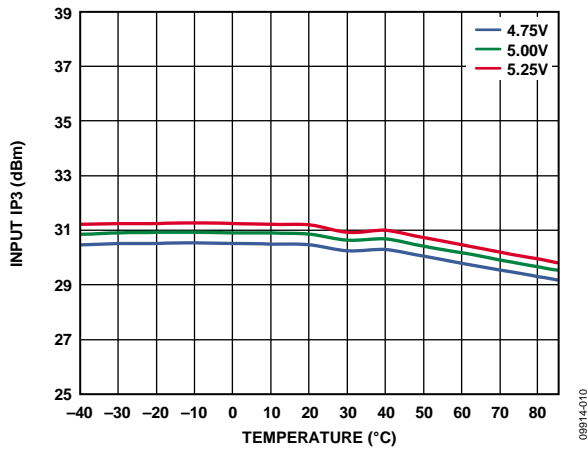

Figure 10. Input IP3 vs. Temperature

$V_S = 5\text{ V}$, $I_S = 100\text{ mA}$, $T_A = 25^\circ\text{C}$, $f_{RF} = 2535\text{ MHz}$, $f_{LO} = 2738\text{ MHz}$, LO power = 0 dBm, $V_{GS0} = V_{GS1} = 0\text{ V}$, and $Z_O = 50\ \Omega$, unless otherwise noted.

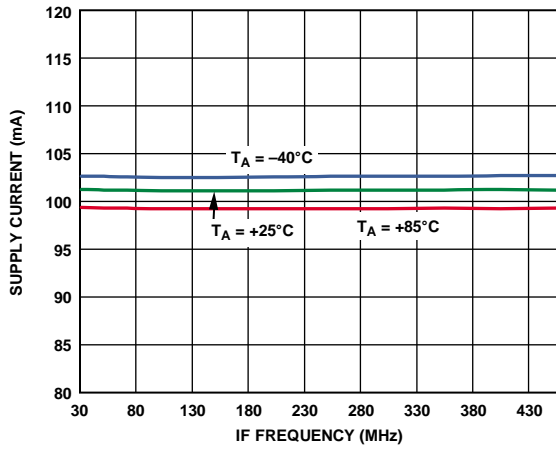

Figure 13. Supply Current vs. IF Frequency

08914-013

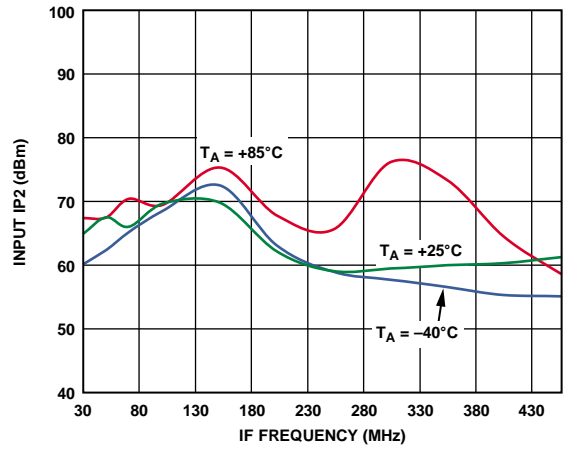

Figure 16. Input IP2 vs. IF Frequency

08914-016

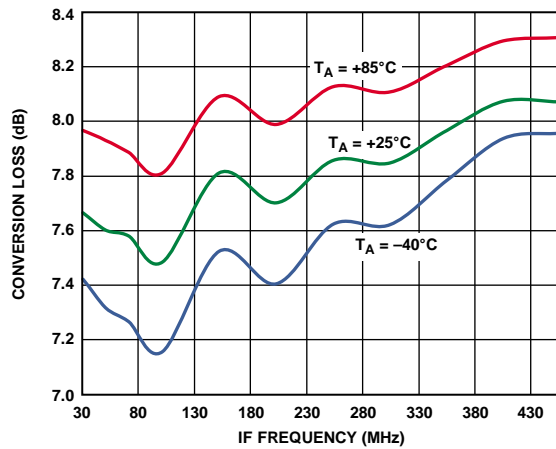

Figure 14. Power Conversion Loss vs. IF Frequency

08914-014

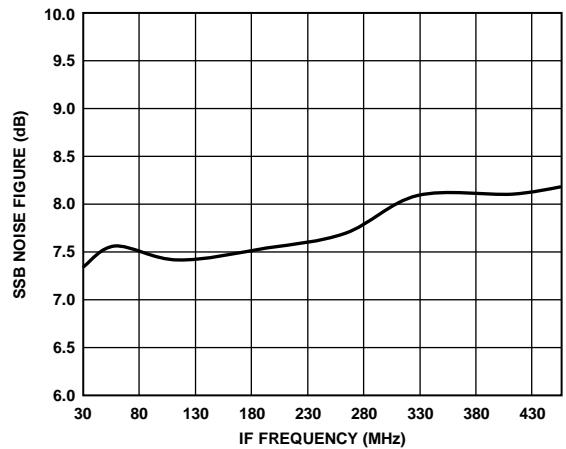

Figure 17. SSB Noise Figure vs. IF Frequency

08914-017

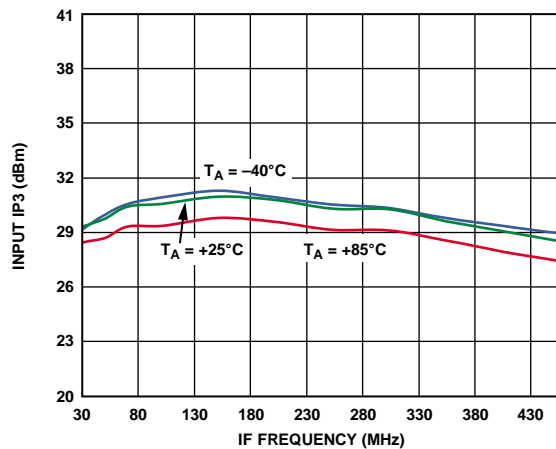

Figure 15. Input IP3 vs. IF Frequency

08914-015

$V_S = 5\text{ V}$, $I_S = 100\text{ mA}$, $T_A = 25^\circ\text{C}$, $f_{RF} = 2535\text{ MHz}$, $f_{LO} = 2738\text{ MHz}$, LO power = 0 dBm, VGS0 = VGS1 = 0 V, and $Z_O = 50\ \Omega$, unless otherwise noted.

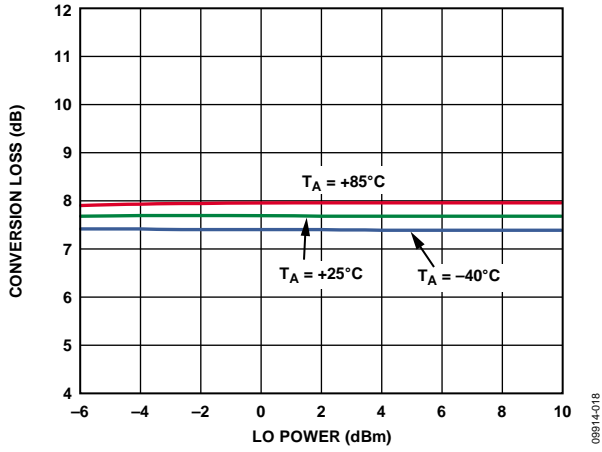

Figure 18. Power Conversion Loss vs. LO Power

09914-018

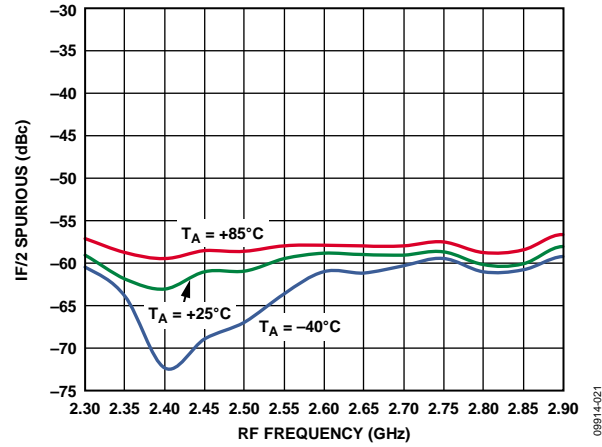

Figure 21. IF/2 Spurious vs. RF Frequency

09914-021

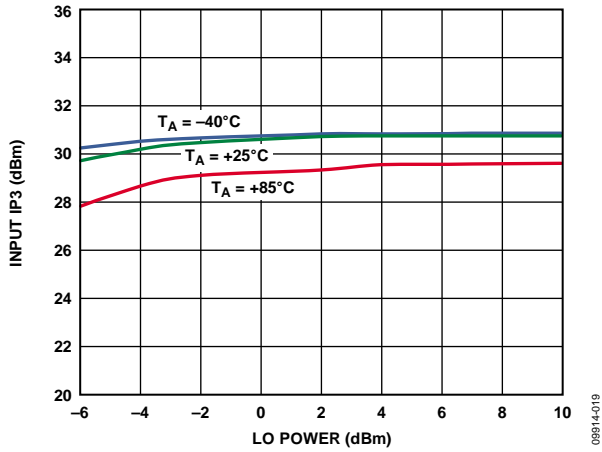

Figure 19. Input IP3 vs. LO Power

09914-019

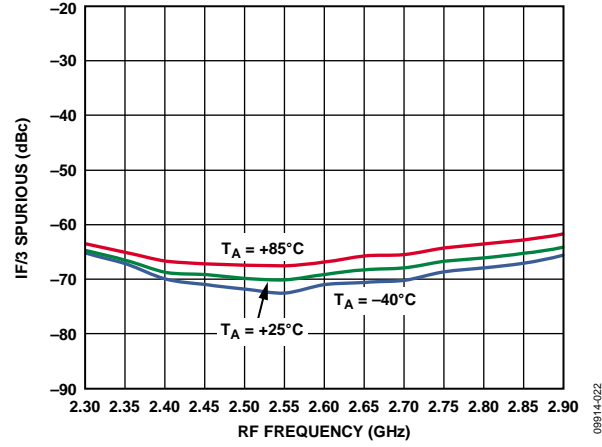

Figure 22. IF/3 Spurious vs. RF Frequency

09914-022

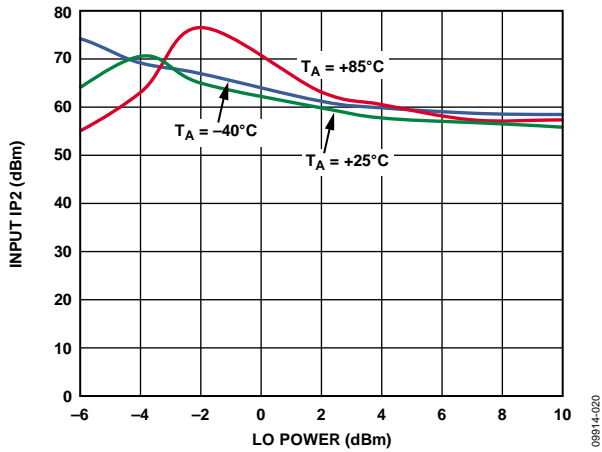

Figure 20. Input IP2 vs. LO Power

09914-020

$V_S = 5\text{ V}$, $I_S = 100\text{ mA}$, $T_A = 25^\circ\text{C}$, $f_{RF} = 2535\text{ MHz}$, $f_{LO} = 2738\text{ MHz}$, LO power = 0 dBm, $V_{GS0} = V_{GS1} = 0\text{ V}$, and $Z_O = 50\ \Omega$, unless otherwise noted.

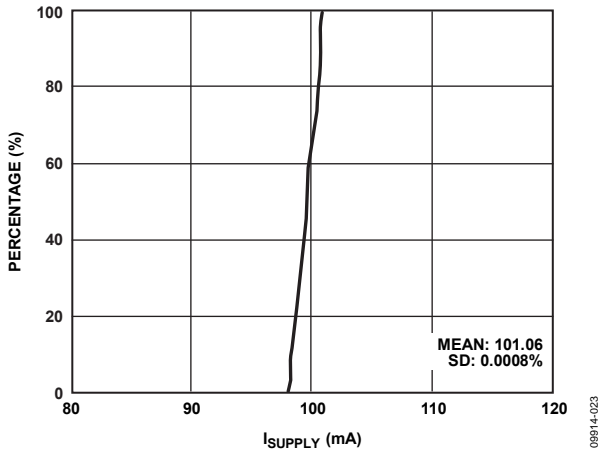

Figure 23. Supply Current Distribution

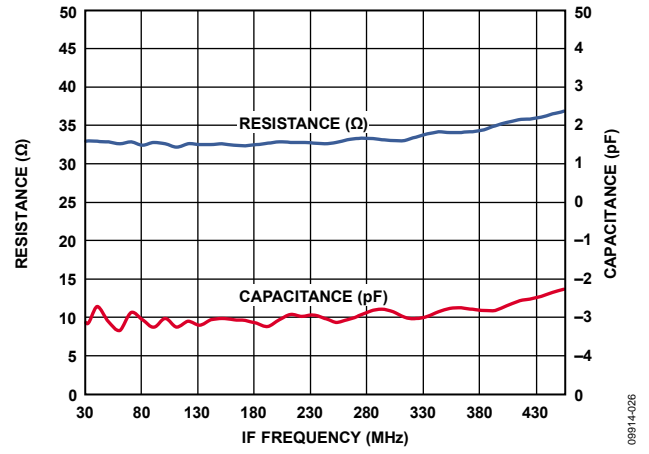

Figure 26. IF Output Impedance (R Parallel, C Equivalent)

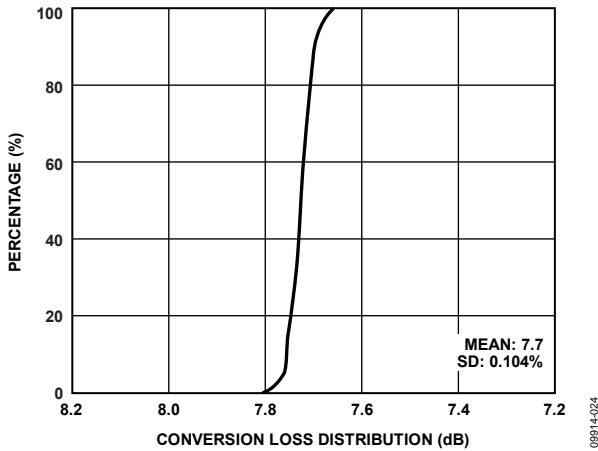

Figure 24. Conversion Loss Distribution

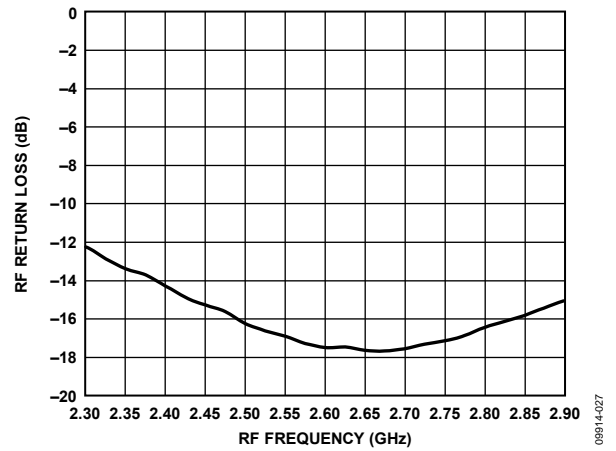

Figure 27. RF Port Return Loss, Fixed IF

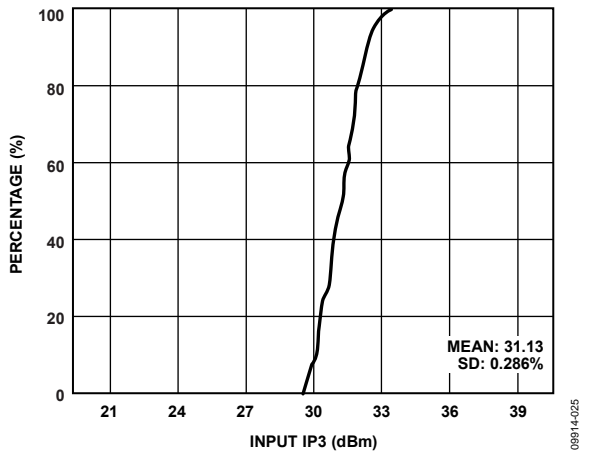

Figure 25. Input IP3 Distribution

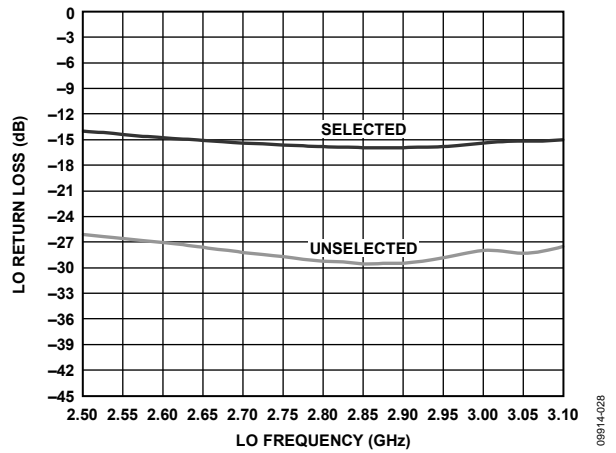

Figure 28. LO Return Loss, Selected and Unselected

$V_S = 5\text{ V}$, $I_S = 100\text{ mA}$, $T_A = 25^\circ\text{C}$, $f_{RF} = 2535\text{ MHz}$, $f_{LO} = 2738\text{ MHz}$, LO power = 0 dBm, $V_{GS0} = V_{GS1} = 0\text{ V}$, and $Z_O = 50\ \Omega$, unless otherwise noted.

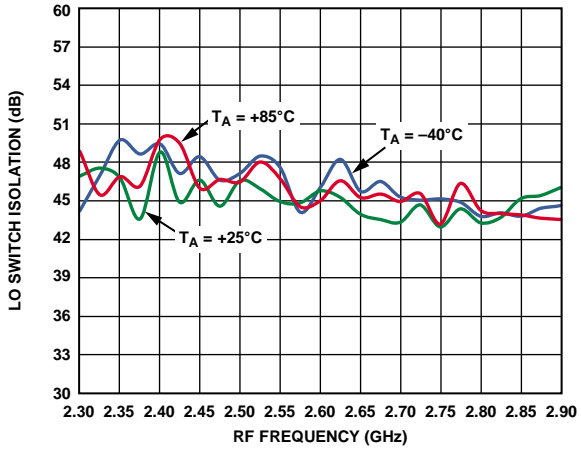

Figure 29. LO Switch Isolation vs. RF Frequency

09914-029

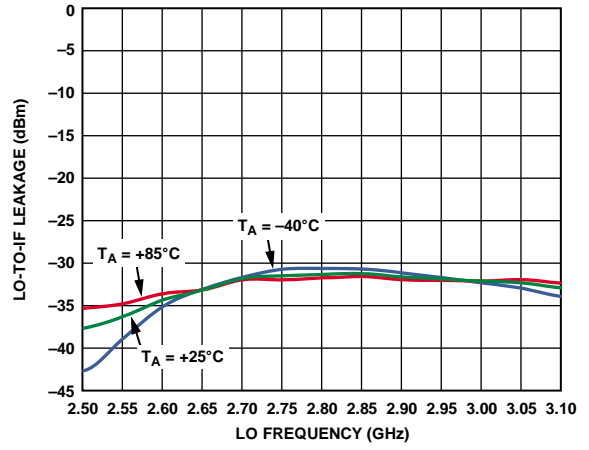

Figure 32. LO-to-RF Leakage vs. LO Frequency

09914-032

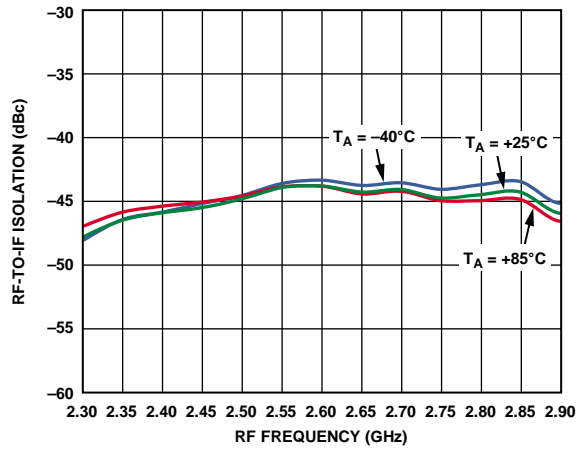

Figure 30. RF-to-IF Isolation vs. RF Frequency

09914-030

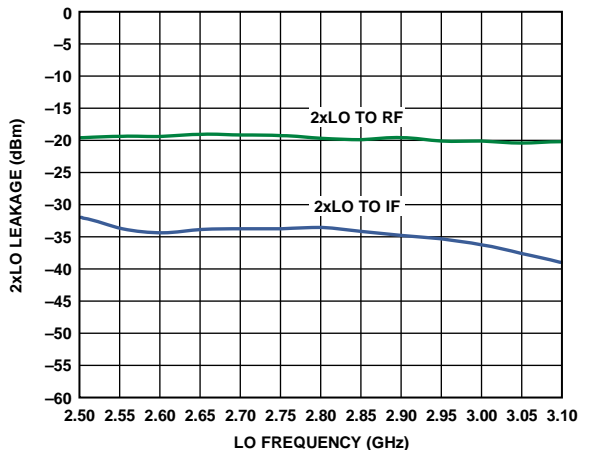

Figure 33. 2LO Leakage vs. LO Frequency

09914-033

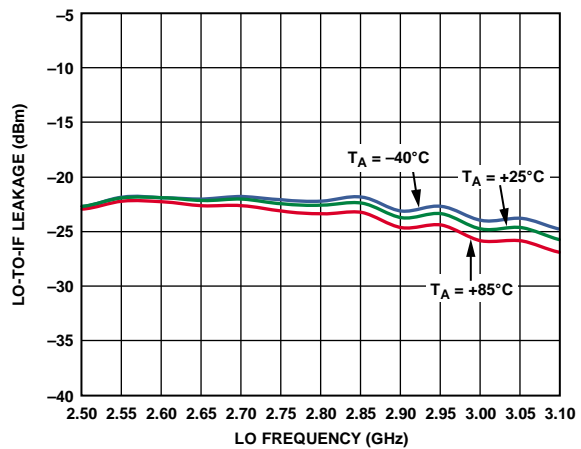

Figure 31. LO-to-IF Leakage vs. LO Frequency

09914-031

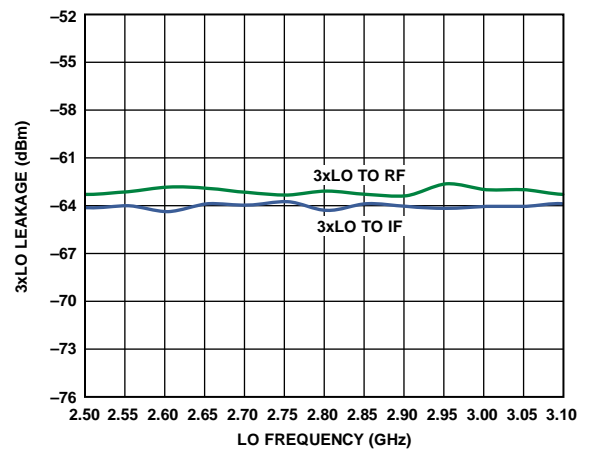

Figure 34. 3LO Leakage vs. LO Frequency

09914-034

$V_S = 5\text{ V}$, $I_S = 100\text{ mA}$, $T_A = 25^\circ\text{C}$, $f_{RF} = 2535\text{ MHz}$, $f_{LO} = 2738\text{ MHz}$, LO power = 0 dBm, $V_{GS0} = V_{GS1} = 0\text{ V}$, and $Z_O = 50\ \Omega$, unless otherwise noted.

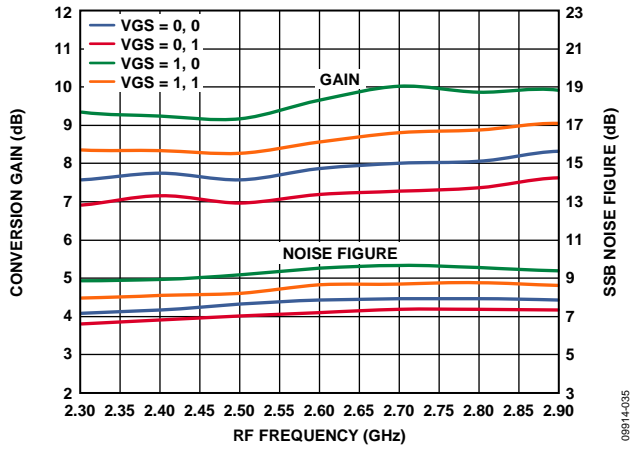

Figure 35. Power Conversion Loss and SSB Noise Figure vs. RF Frequency

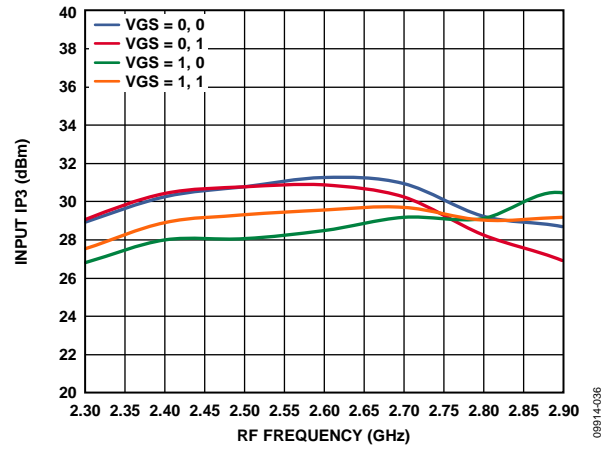

Figure 36. Input IP3 vs. RF Frequency

3.3 V PERFORMANCE

$V_S = 3.3\text{ V}$, $I_S = 60\text{ mA}$, $T_A = 25^\circ\text{C}$, $f_{RF} = 2535\text{ MHz}$, $f_{LO} = 2738\text{ MHz}$, LO power = 0 dBm, VGS0 = VGS1 = 0 V, and $Z_O = 50\ \Omega$, unless otherwise noted.

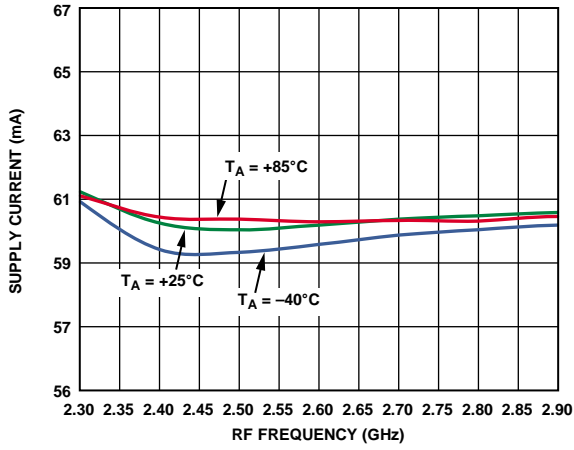

Figure 37. Supply Current vs. RF Frequency at 3.3 V

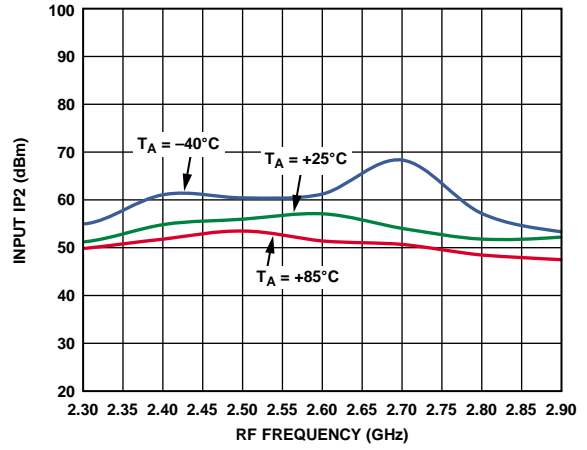

Figure 40. Input IP2 vs. RF Frequency at 3.3 V

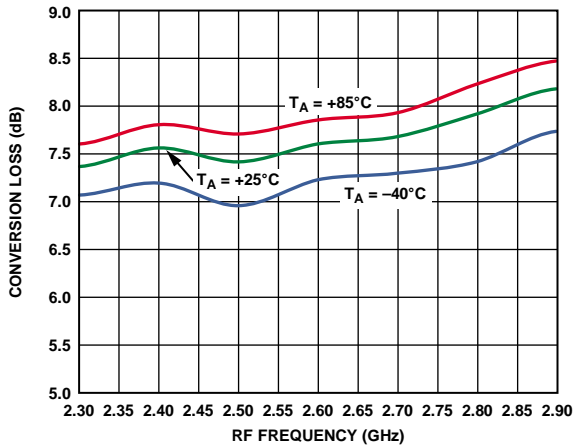

Figure 38. Power Conversion Loss vs. RF Frequency at 3.3 V

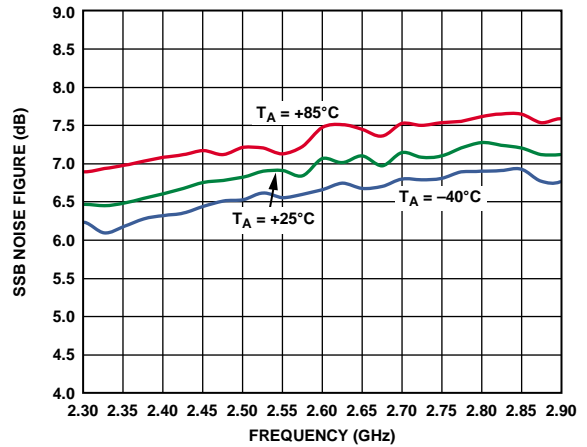

Figure 41. SSB Noise Figure vs. RF Frequency at 3.3 V

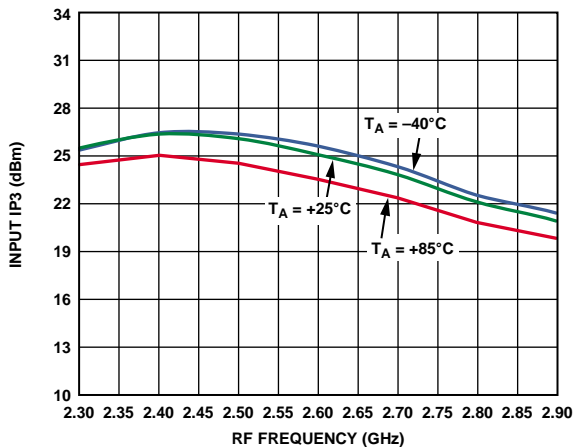

Figure 39. Input IP3 vs. RF Frequency at 3.3 V

09914-039

09914-042

09914-040

09914-043

09914-041

UPCONVERSION

$V_S = 5\text{ V}$, $I_S = 100\text{ mA}$, $T_A = 25^\circ\text{C}$, $f_{RF} = 2535\text{ MHz}$, $f_{LO} = 2738\text{ MHz}$, LO power = 0 dBm, VGS0 = VGS1 = 0 V, and $Z_O = 50\ \Omega$, unless otherwise noted.

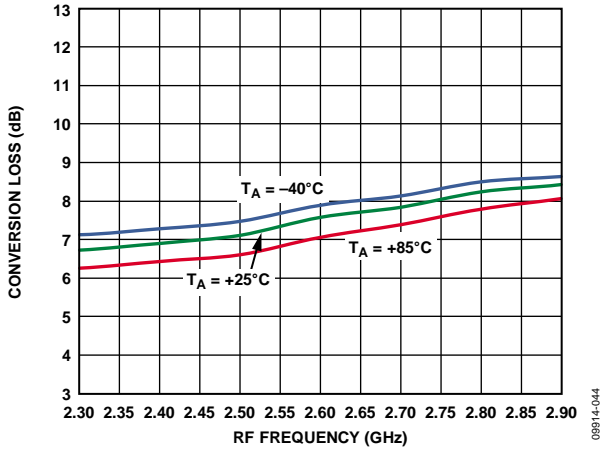

Figure 42. Power Conversion Loss vs. RF Frequency, $V_S = 5\text{ V}$, Upconversion

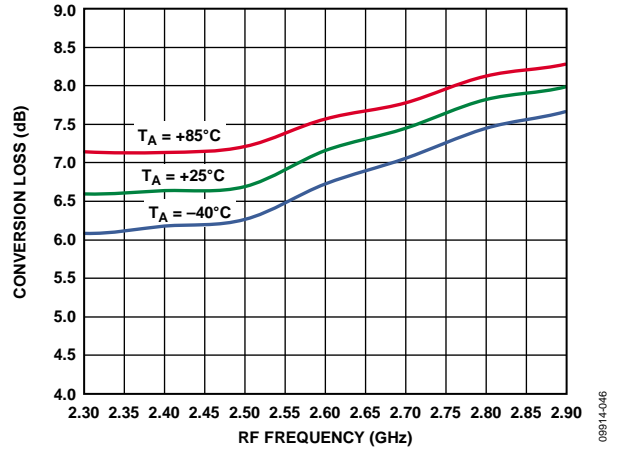

Figure 44. Power Conversion Loss vs. RF Frequency at 3.3 V, Upconversion

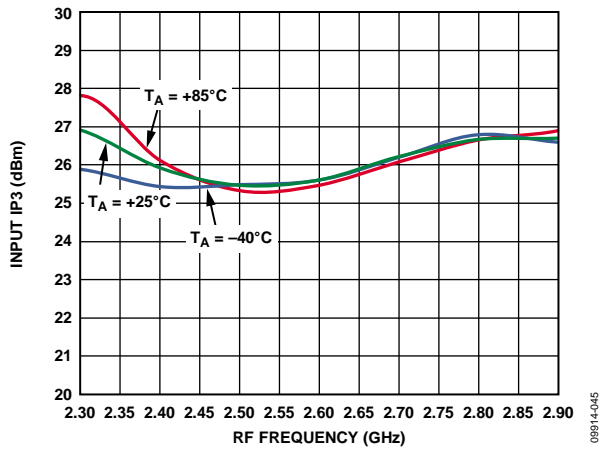

Figure 43. Input IP3 vs. RF Frequency, $V_S = 5\text{ V}$, Upconversion

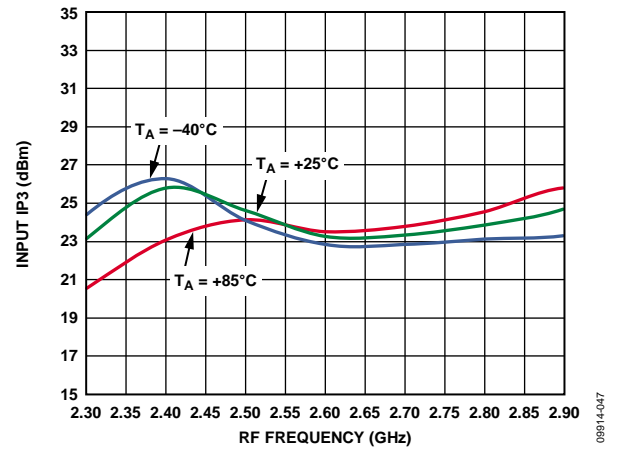

Figure 45. Input IP3 vs. RF Frequency at 3.3 V, Upconversion

SPURIOUS PERFORMANCE

$(N \times f_{RF}) - (M \times f_{LO})$ spur measurements were made using the standard evaluation board. Mixer spurious products are measured in dBc from the IF output power level. Data was measured only for frequencies less than 6 GHz. Typical noise floor of the measurement system = -100 dBm.

5 V Performance

$V_S = 5\text{ V}$, $I_S = 100\text{ mA}$, $T_A = 25^\circ\text{C}$, $f_{RF} = 2535\text{ MHz}$, $f_{LO} = 2738\text{ MHz}$, LO power = 0 dBm, RF power = 0 dBm, $V_{GS0} = V_{GS1} = 0\text{ V}$, and $Z_O = 50\ \Omega$, unless otherwise noted.

| | | M | | | | | | | | | | | | | | | |
|---|----|-------|-------|-------|-------|-------|-------|-------|-------|-------|-------|-------|-------|-------|-------|-------|-------|
| | | 0 | 1 | 2 | 3 | 4 | 5 | 6 | 7 | 8 | 9 | 10 | 11 | 12 | 13 | 14 | 15 |
| N | 0 | | -10.9 | -28.3 | -44.5 | | | | | | | | | | | | |
| | 1 | -42.2 | 0.0 | -49.3 | -31.2 | -49.8 | | | | | | | | | | | |
| | 2 | -75.8 | -76.5 | -64.6 | -78.4 | -78.5 | -94.7 | | | | | | | | | | |
| | 3 | <-100 | -83.0 | <-100 | -73.5 | -90.9 | -89.8 | <-100 | | | | | | | | | |
| | 4 | | <-100 | <-100 | <-100 | <-100 | <-100 | <-100 | <-100 | <-100 | | | | | | | |
| | 5 | | | | <-100 | <-100 | <-100 | <-100 | <-100 | <-100 | <-100 | | | | | | |
| | 6 | | | | | <-100 | <-100 | <-100 | <-100 | <-100 | <-100 | <-100 | | | | | |
| | 7 | | | | | | <-100 | <-100 | <-100 | <-100 | <-100 | <-100 | <-100 | | | | |
| | 8 | | | | | | | <-100 | <-100 | <-100 | <-100 | <-100 | <-100 | <-100 | | | |
| | 9 | | | | | | | | <-100 | <-100 | <-100 | <-100 | <-100 | <-100 | <-100 | | |
| | 10 | | | | | | | | | <-100 | <-100 | <-100 | <-100 | <-100 | <-100 | <-100 | |
| | 11 | | | | | | | | | | <-100 | <-100 | <-100 | <-100 | <-100 | <-100 | <-100 |
| | 12 | | | | | | | | | | | <-100 | <-100 | <-100 | <-100 | <-100 | <-100 |
| | 13 | | | | | | | | | | | | <-100 | <-100 | <-100 | <-100 | <-100 |
| | 14 | | | | | | | | | | | | | <-100 | <-100 | <-100 | <-100 |
| | 15 | | | | | | | | | | | | | | <-100 | <-100 | <-100 |

3.3 V Performance

$V_S = 3.3\text{ V}$, $I_S = 56\text{ mA}$, $T_A = 25^\circ\text{C}$, $f_{RF} = 2535\text{ MHz}$, $f_{LO} = 2738\text{ MHz}$, LO power = 0 dBm, RF power = 0 dBm, $R_9 = 226\ \Omega$, $V_{GS0} = V_{GS1} = 0\text{ V}$, and $Z_O = 50\ \Omega$, unless otherwise noted.

| | | M | | | | | | | | | | | | | | | |
|---|----|-------|-------|-------|-------|-------|-------|-------|-------|-------|-------|-------|-------|-------|-------|-------|-------|
| | | 0 | 1 | 2 | 3 | 4 | 5 | 6 | 7 | 8 | 9 | 10 | 11 | 12 | 13 | 14 | 15 |
| N | 0 | | -16.9 | -35.1 | -61.4 | | | | | | | | | | | | |
| | 1 | -41.9 | 0.0 | -49.1 | -30.4 | -52.6 | | | | | | | | | | | |
| | 2 | -72.3 | -80.3 | -62.7 | -68.5 | -71.9 | <-100 | | | | | | | | | | |
| | 3 | -94.6 | -71.6 | <-100 | -61.2 | -92.7 | -75.1 | <-100 | | | | | | | | | |
| | 4 | | <-100 | <-100 | <-100 | <-100 | <-100 | <-100 | <-100 | <-100 | | | | | | | |
| | 5 | | | | <-100 | <-100 | <-100 | <-100 | <-100 | <-100 | <-100 | | | | | | |
| | 6 | | | | | <-100 | <-100 | <-100 | <-100 | <-100 | <-100 | <-100 | | | | | |
| | 7 | | | | | | <-100 | <-100 | <-100 | <-100 | <-100 | <-100 | <-100 | | | | |
| | 8 | | | | | | | <-100 | <-100 | <-100 | <-100 | <-100 | <-100 | <-100 | | | |
| | 9 | | | | | | | | <-100 | <-100 | <-100 | <-100 | <-100 | <-100 | <-100 | | |
| | 10 | | | | | | | | | <-100 | <-100 | <-100 | <-100 | <-100 | <-100 | <-100 | |
| | 11 | | | | | | | | | | <-100 | <-100 | <-100 | <-100 | <-100 | <-100 | <-100 |
| | 12 | | | | | | | | | | | <-100 | <-100 | <-100 | <-100 | <-100 | <-100 |
| | 13 | | | | | | | | | | | | <-100 | <-100 | <-100 | <-100 | <-100 |
| | 14 | | | | | | | | | | | | | <-100 | <-100 | <-100 | <-100 |
| | 15 | | | | | | | | | | | | | | | <-100 | <-100 |

CIRCUIT DESCRIPTION

The ADL5363 consists of two primary components: the radio frequency (RF) subsystem and the local oscillator (LO) subsystem. The combination of design, process, and packaging technology allows the functions of these subsystems to be integrated into a single die, using mature packaging and interconnection technologies to provide a high performance, low cost design with excellent electrical, mechanical, and thermal properties. In addition, the need for external components is minimized, optimizing cost and size.

The RF subsystem consists of an integrated, low loss RF balun, passive MOSFET mixer, sum termination network.

The LO subsystem consists of an SPDT-terminated FET switch and a three-stage limiting LO amplifier. The purpose of the LO subsystem is to provide a large, fixed amplitude, balanced signal to drive the mixer independent of the level of the LO input.

A block diagram of the device is shown in Figure 46.

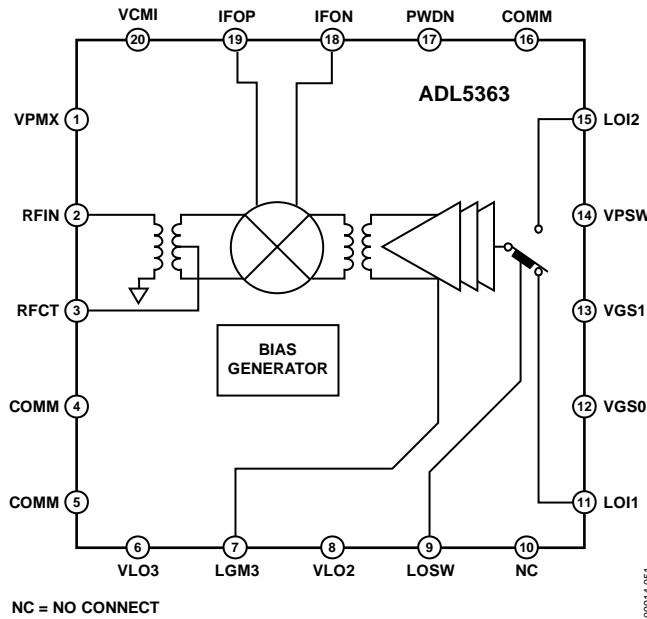

Figure 46. Simplified Schematic

RF SUBSYSTEM

The single-ended, 50 Ω RF input is internally transformed to a balanced signal using a low loss (<1 dB) unbalanced-to-balanced (balun) transformer. This transformer is made possible by an extremely low loss metal stack, which provides both excellent balance and dc isolation for the RF port. Although the port can be dc connected, it is recommended that a blocking capacitor be used to avoid running excessive dc current through the part. The RF balun can easily support an RF input frequency range of 2300 MHz to 2900 MHz.

The resulting balanced RF signal is applied to a passive mixer that commutates the RF input with the output of the LO subsystem. The passive mixer is essentially a balanced, low loss switch that adds minimum noise to the frequency translation. The only noise contribution from the mixer is due to the resistive loss of the switches, which is in the order of a few ohms.

As the mixer is inherently broadband and bidirectional, it is necessary to properly terminate all the idler ($M \times N$ product) frequencies generated by the mixing process. Terminating the mixer avoids the generation of unwanted intermodulation products and reduces the level of unwanted signals at the IF output. This termination is accomplished by the addition of a sum network between the IF output and the mixer.

The IP3 performance can be optimized by adjusting the supply current with an external resistor. Figure 37 and 38 illustrate how the bias resistor affects the performance with a 5 V supply. Additionally, dc current can be saved by increasing either or both resistors. It is permissible to reduce the dc supply voltage to as low as 3.3 V, further reducing the dissipated power of the part. (Note that no performance enhancement is obtained by reducing the value of these resistors and excessive dc power dissipation may result.)

LO SUBSYSTEM

The ADL5363 has two LO inputs permitting multiple synthesizers to be rapidly switched with extremely short switching times (<40 ns) for frequency agile applications. The two inputs are applied to a high isolation SPDT switch that provides a constant input impedance, regardless of whether the port is selected, to avoid pulling the LO sources. This multiple section switch also ensures high isolation to the off input, minimizing any leakage from the unwanted LO input that may result in undesired IF responses.

The single-ended LO input is converted to a fixed amplitude differential signal using a multistage, limiting LO amplifier. This results in consistent performance over a range of LO input power. Optimum performance is achieved from -6 dBm to +10 dBm, but the circuit continues to function at considerably lower levels of LO input power.

The performance of this amplifier is critical in achieving a high intercept passive mixer without degrading the noise floor of the system. This is a critical requirement in an interferer rich environment, such as cellular infrastructure, where blocking

interferers can limit mixer performance. The bandwidth of the intermodulation performance is somewhat influenced by the current in the LO amplifier chain. For dc current sensitive applications, it is permissible to reduce the current in the LO amplifier by raising the value of the external bias control resistor. For dc current critical applications, the LO chain can operate with a supply voltage as low as 3.3 V, resulting in substantial dc power savings.

In addition, when operating with supply voltages below 3.6 V, the ADL5363 has a power-down mode that permits the dc current to drop to <200 μ A.

All of the logic inputs are designed to work with any logic family that provides a Logic 0 input level of less than 0.4 V and a Logic 1 input level that exceeds 1.4 V. All logic inputs are high impedance up to Logic 1 levels of 3.3 V. At levels exceeding 3.3 V, protection circuitry permits operation up to 5.5 V, although a small bias current is drawn.

All pins, including the RF pins, are ESD protected and have been tested up to a level of 1500 V HBM and 1250 V CDM.

APPLICATIONS INFORMATION

BASIC CONNECTIONS

The ADL5363 mixer is designed to downconvert radio frequencies (RF) primarily between 2300 MHz and 2900 MHz to lower intermediate frequencies (IF) between 30 MHz and 450 MHz. Figure 47 depicts the basic connections of the mixer. To prevent nonzero dc voltages from damaging the RF balun or LO input circuit, ac-couple the RF and LO input ports. The RFIN matching network consists of a series 1.5 pF capacitor and a shunt 12 nH inductor to provide the optimized RF input return loss for the desired frequency band.

IF PORT

The real part of the output impedance is approximately 50 Ω, as seen in Figure 26, which matches many commonly used SAW filters without the need for a transformer. This results in a voltage conversion loss that is approximately the same as the power conversion loss, as shown in Table 3.

MIXER VGS CONTROL DAC

The ADL5363 features two logic control pins, VGS0 (Pin 12) and VGS1 (Pin 13), that allow programmability for internal gate-to-source voltages for optimizing mixer performance over desired frequency bands. The evaluation board defaults both VGS0 and VGS1 to ground.

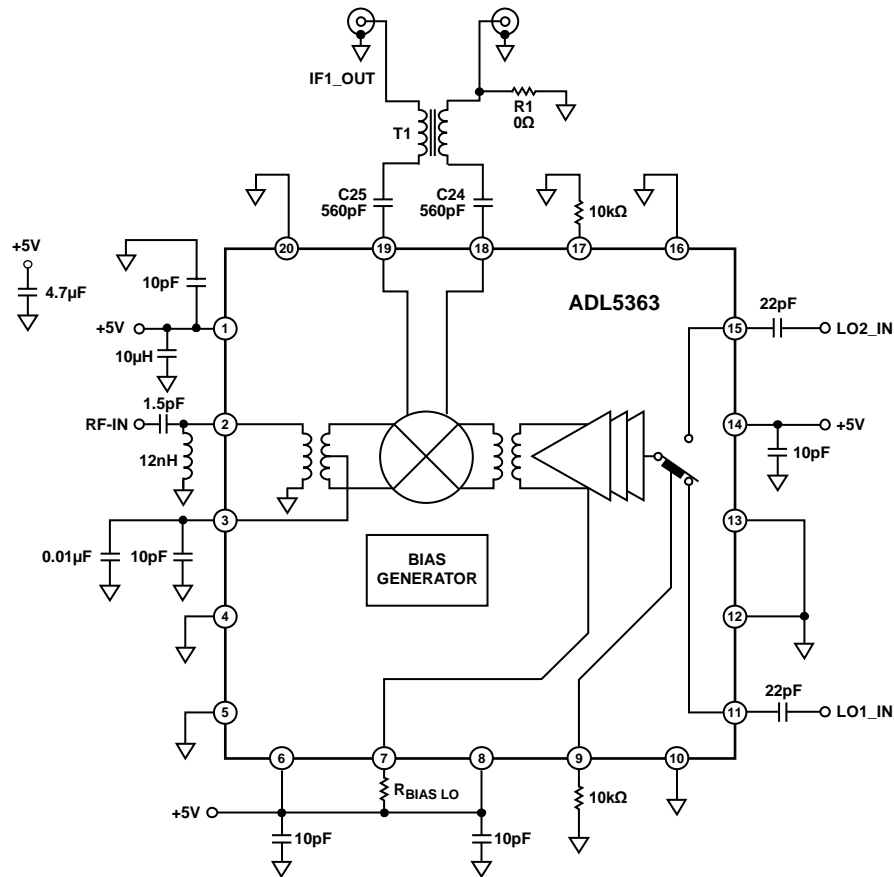

Figure 47. Typical Application Circuit

08914-032

EVALUATION BOARD

An evaluation board is available for the family of double balanced mixers. The standard evaluation board schematic is shown in Figure 48. The evaluation board is fabricated using Rogers® RO3003 material. Table 7 describes the various configuration options of the evaluation board. Evaluation board layout is shown in Figure 49 to Figure 52.

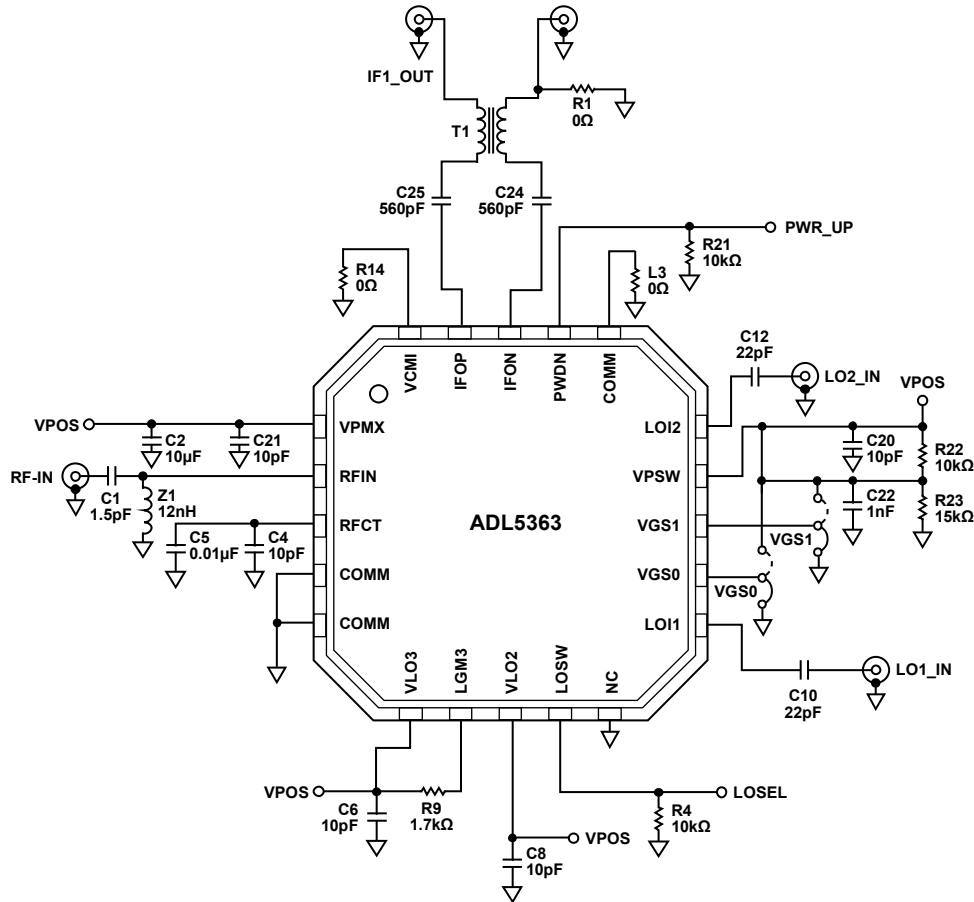

Figure 48. Evaluation Board Schematic

09914-063

Table 7. Evaluation Board Configuration

| Components | Function | Description | Default Conditions |
|--|-------------------------|---|---|
| C2, C6, C8, C20, C21 | Power supply decoupling | Power Supply Decoupling. Nominal supply decoupling consists of a 10 μ F capacitor to ground in parallel with a 10 pF capacitor to ground positioned as close to the device as possible. | C2 = 10 μ F (size 0603), C6, C8, C20, C21 = 10 pF (size 0402) |
| C1, C4, C5, Z1 | RF input interface | RF Input Interface. The input channels are ac-coupled through C1. C4 and C5 provide bypassing for the center taps of the RF input baluns. | C1 = 1.5 pF (size 0402), C4 = 10 pF (size 0402), C5 = 0.01 μ F (size 0402) Z1 = 12 nH (size 0402) |
| T1, R1, C24, C25 | IF output interface | IF Output Interface. T1 is a 1:1 impedance transformer used to provide a single-ended IF output interface. Remove R1 for balanced output operation. C24 and C25 are used to block the dc bias at the IF ports. | T1 = TC1-1-13M+ (Mini-Circuits), R1 = 0 Ω (size 0402), C24, C25 = 560 pF (size 0402) |
| C10, C12, R4 | LO interface | LO Interface. C10 and C12 provide ac coupling for the LO1_IN and LO2_IN local oscillator inputs. LOSEL selects the appropriate LO input for both mixer cores. R4 provides a pull-down to ensure that LO1_IN is enabled when the LOSEL test point is logic low. LO2_IN is enabled when LOSEL is pulled to logic high. | C10, C12 = 22 pF (size 0402), R4 = 10 k Ω (size 0402) |
| R21 | PWDN interface | PWDN Interface. R21 pulls the PWDN logic low and enables the device. The PWR_UP test point allows the PWDN interface to be exercised using the an external logic generator. Grounding the PWDN pin for nominal operation is allowed. Using the PWDN pin when supply voltages exceed 3.3 V is not allowed. | R21 = 10 k Ω (size 0402) |
| C22, L3, R9, R14, R22, R23, VGS0, VGS1 | Bias control | Bias Control. R22 and R23 form a voltage divider to provide 3 V for logic control, bypassed to ground through C22. VGS0 and VGS1 jumpers provide programmability at the VGS0 and VGS1 pins. It is recommended to pull these two pins to ground for nominal operation. R9 sets the bias point for the internal LO buffers. | C22 = 1 nF (size 0402), L3 = 0 Ω (size 0603), R9 = 1.7 k Ω (size 0402), R14 = 0 Ω (size 0402), R22 = 10 k Ω (size 0402), R23 = 15 k Ω (size 0402), VGS0 = VGS1 = 3-pin shunt |

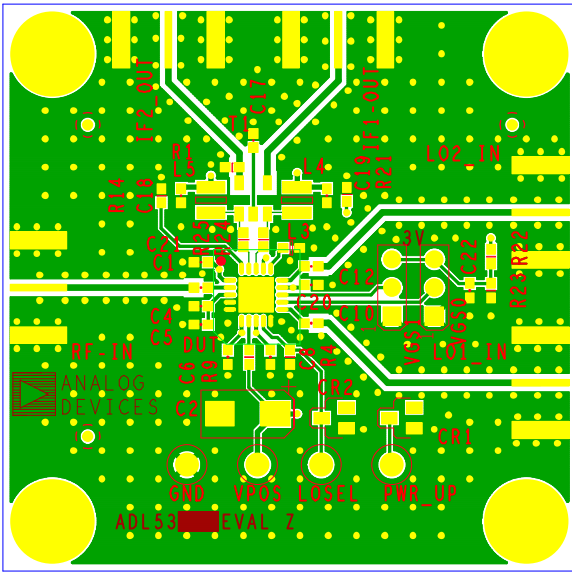

Figure 49. Evaluation Board Top Layer

09914-152

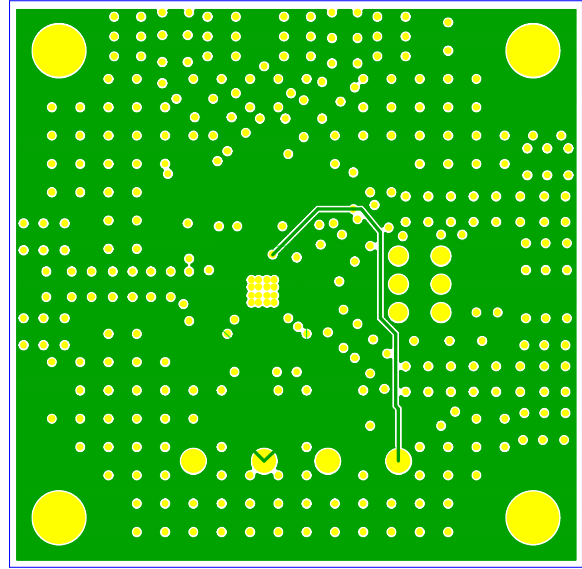

Figure 51. Evaluation Board Power Plane, Internal Layer 2

09914-154

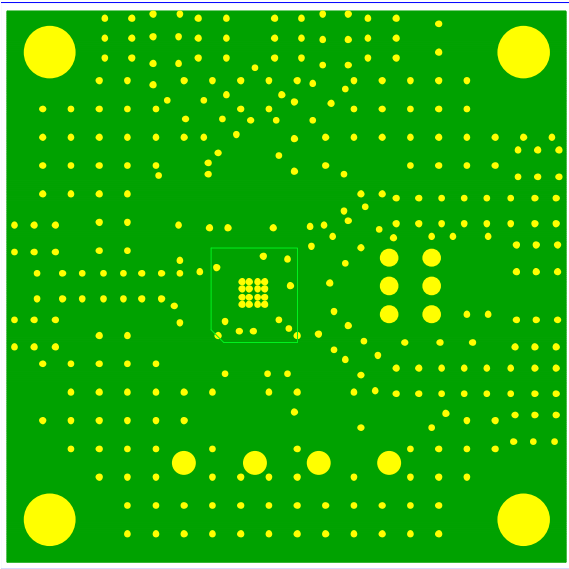

Figure 50. Evaluation Board Ground Plane, Internal Layer 1

09914-153

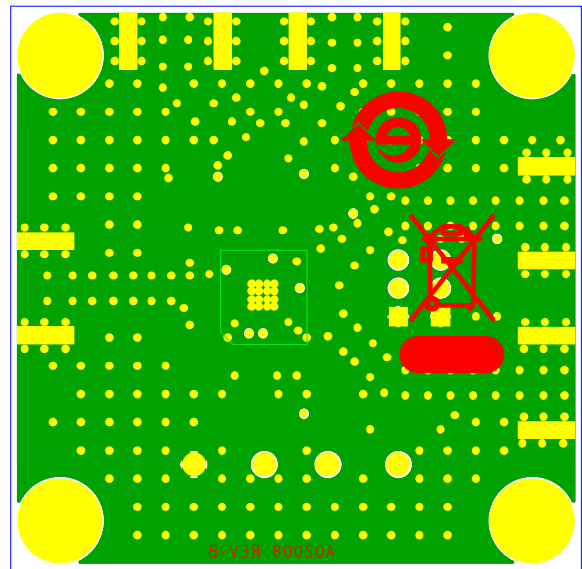
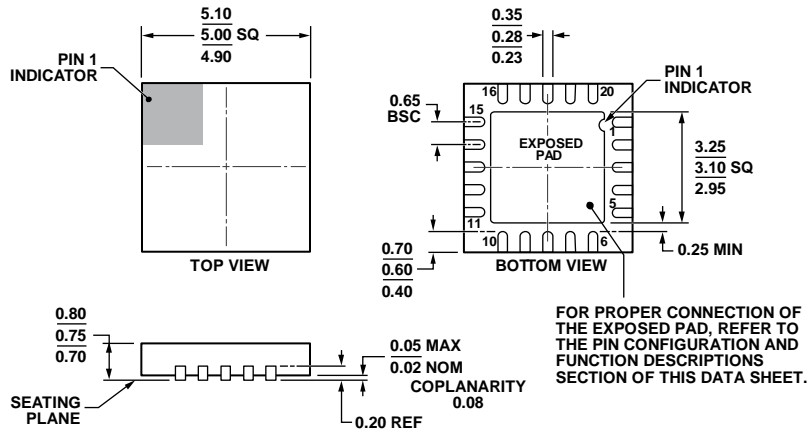

Figure 52. Evaluation Board Bottom Layer

09914-155

OUTLINE DIMENSIONS



COMPLIANT TO JEDEC STANDARDS MO-220-WHHC.
 Figure 53. 20-Lead Lead Frame Chip Scale Package [LFCSP_WQ]
 5 mm × 5 mm Body, Very Very Thin Quad
 (CP-20-9)
 Dimensions shown in millimeters

111908A

ORDERING GUIDE

| Model ¹ | Temperature Range | Package Description | Package Option | Ordering Quantity |
|--------------------|-------------------|---|----------------|-------------------|
| ADL5363ACPZ-R7 | -40°C to +85°C | 20-Lead Lead Frame Chip Scale Package [LFCSP_WQ] 7" Tape and Reel | CP-20-9 | 1,500 |
| ADL5363-EVALZ | | Evaluation Board | | 1 |

¹ Z = RoHS Compliant Part.

NOTES