

## MCR12DSM, MCR12DSN

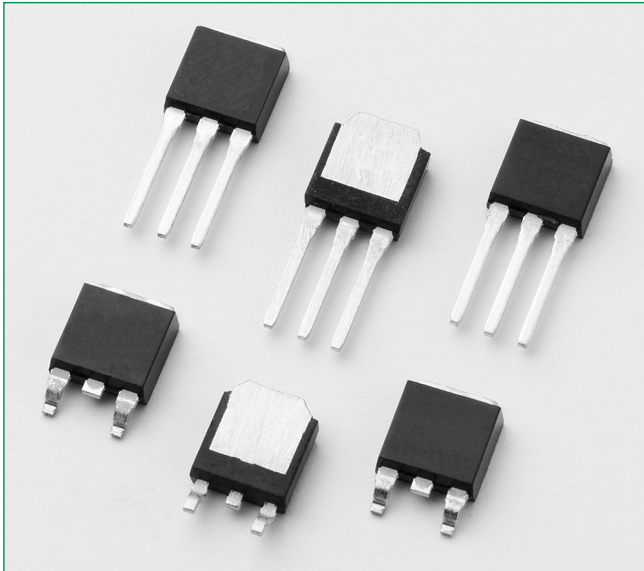

### Description

Designed for high volume, low cost, industrial and consumer applications such as motor control; process control; temperature, light and speed control; CDI (Capacitive Discharge Ignition); and small engines.

### Features

- Small Size
- Passivated Die Surface for Reliability and Uniformity
- Low Level Triggering and Holding Characteristics
- UL Recognized compound meeting flammability rating V-0
- ESD Ratings: Human Body Model, 3B > 8000 V  
Machine Model, C > 400 V

### Pin Out

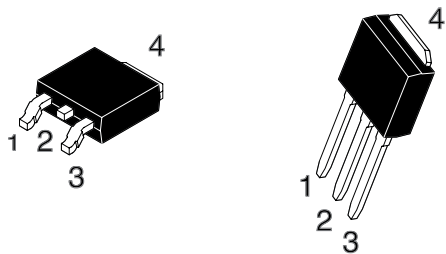

### Functional Diagram

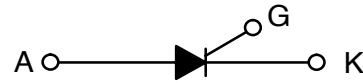

### Additional Information



Datasheet



Resources



Samples

### Maximum Ratings ( $T_J = 25^\circ\text{C}$ unless otherwise noted)

Rating	Symbol	Value	Unit
Peak Repetitive Off-State Voltage (Note 1) ( $T_C = -40$ to $+110^\circ\text{C}$ , Sine Wave, 50 to 60 Hz, $R_{GK} = 1\text{ k}\Omega$ )	MCR12DSM MCR12DSN $V_{DRM}$ $V_{RRM}$	600 800	V
On-State RMS Current (180° Conduction Angles; $T_C = 75^\circ\text{C}$ )	$I_{T(RMS)}$	12	A
Average On-State Current (180° Conduction Angles; $T_C = 75^\circ\text{C}$ )	$I_{T(AV)}$	76	A
Non-Repetitive Surge Current (1/2 Cycle, Sine Wave 60 Hz, $T_J = 110^\circ\text{C}$ )	$I_{TSM}$	100	A
Circuit Fusing Consideration ( $t = 8.3\text{ ms}$ )	$I^2t$	41	$\text{A}^2\text{s}$
Forward Peak Gate Power (Pulse Width $\leq 1.0\text{ }\mu\text{sec}$ , $T_C = 75^\circ\text{C}$ )	$P_{GM}$	5.0	W
Forward Average Gate Power ( $t = 8.3\text{ ms}$ , $T_C = 75^\circ\text{C}$ )	$P_{G(AV)}$	0.5	W
Forward Peak Gate Current (Pulse Width $\leq 1.0\text{ }\mu\text{sec}$ , $T_C = 75^\circ\text{C}$ )	$I_{GM}$	2.0	A
Operating Junction Temperature Range	$T_J$	-40 to +110	$^\circ\text{C}$
Storage Temperature Range	$T_{stg}$	-40 to +150	$^\circ\text{C}$

Stresses exceeding Maximum Ratings may damage the component. Maximum Ratings are stress ratings only. Functional operation above the Recommended Operating Conditions is not implied. Extended exposure to stresses above the Recommended Operating Conditions may affect component reliability.

<sup>1</sup>  $V_{DRM}$  and  $V_{RRM}$  for all types can be applied on a continuous basis. Ratings apply for zero or negative gate voltage; however, positive gate voltage shall not be applied concurrent with negative potential on the anode. Blocking voltages shall not be tested with a constant current source such that the voltage ratings of the component are exceeded.

### Thermal Characteristics

Rating	Symbol	Value	Unit
Thermal Resistance, Junction-to-Case	$R_{\theta JC}$	2.2	$^\circ\text{C/W}$
Thermal Resistance, Junction-to-Ambient	$R_{\theta JA}$	88	
Thermal Resistance, Junction-to-Ambient (Note 2)	$R_{\theta JA}$	80	
Maximum Lead Temperature for Soldering Purposes (Note 3)	$T_L$	260	$^\circ\text{C}$

### Electrical Characteristics - OFF ( $T_J = 25^\circ\text{C}$ unless otherwise noted)

Characteristic	Symbol	Min	Typ	Max	Unit	
Peak Repetitive Forward or Reverse Blocking Current ( $V_{AK} = \text{Rated } V_{DRM} \text{ or } V_{RRM}$ , $R_{GK} = 1.0\text{ k}\Omega$ ) <sup>4</sup>	$I_{DRM}$ $I_{RRM}$	$T_J = 25^\circ\text{C}$	-	-	10	$\mu\text{A}$
		$T_J = 110^\circ\text{C}$	-	-	500	

### Electrical Characteristics - ON ( $T_J = 25^\circ\text{C}$ unless otherwise noted)

Characteristic	Symbol	Min	Typ	Max	Unit	
Peak Reverse Gate Blocking Voltage, ( $I_{GR} = 10\text{ }\mu\text{A}$ )	$V_{GRM}$	10	12.5	18	V	
Peak Reverse Gate Blocking Current, ( $V_{GR} = 10\text{ V}$ )	$I_{GRM}$	-	-	1.2	$\mu\text{A}$	
Peak Forward On-State Voltage (Note 5), ( $I_{TM} = 20\text{ A}$ )	$V_{TM}$	-	1.3	1.9	V	
Gate Trigger Voltage (Note 6) ( $V_{AK} = 12\text{ Vdc}$ ; $R_L = 100\text{ }\Omega$ , $T_C = 110^\circ$ )	$I_{GT}$	$T_J = 25^\circ\text{C}$	5.0	12	200	$\mu\text{A}$
		$T_J = -40^\circ\text{C}$	-	-	300	
Gate Trigger Voltage (Continuous dc) (Note 6) ( $V_{AK} = 12\text{ V}$ ; $R_L = 100\text{ }\Omega$ )	$V_{GT}$	$T_J = 25^\circ\text{C}$	0.45	0.65	1.0	V
		$T_J = -40^\circ\text{C}$	-	-	1.5	
		$T_J = 110^\circ\text{C}$	0.2	-	-	
Holding Current ( $V_D = 12\text{ V}$ , Initiating Current = 200 mA, $R_{GK} = 1\text{ k}\Omega$ )	$I_H$	$T_J = 25^\circ\text{C}$	0.5	1.0	6.0	mA
		$T_J = -40^\circ\text{C}$	-	-	10	
Latching Current ( $V_D = 12\text{ V}$ , $I_G = 2.0\text{ mA}$ , $R_{GK} = 1\text{ k}\Omega$ )	$I_L$	$T_J = 25^\circ\text{C}$	0.5	1.0	6.0	mA
		$T_J = -40^\circ\text{C}$	-	-	10	
Peak Reverse Gate Blocking Current ( $V_{GR} = 10\text{ V}$ )	$I_{RGM}$	-	-	1.2	$\mu\text{A}$	
Turn-On Time (Source Voltage = 12 V, $R_S = 6.0\text{ k}\Omega$ , $I_T = 16\text{ A(pk)}$ , $R_{GK} = 1.0\text{ k}\Omega$ ) ( $V_D = \text{Rated } V_{DRM}$ , Rise Time = 20 ns, Pulse Width = 10 $\mu\text{s}$ )	$t_{gt}$	-	2.0	5.0	$\mu\text{s}$	

**Dynamic Characteristics**

Characteristic	Symbol	Min	Typ	Max	Unit
Critical Rate of Rise of Off-State Voltage (VD = 0.67 x Rated VDRM, Exponential Waveform, RGK = 1.0 K, TJ = 110°C)	dv/dt	2.0	10	-	V/μs
Critical Rate of Rise of On-State Current (IPK = 50 A, PW = 40 sec, diG/dt = 1 A/sec, IGT = 10 mA)	di/dt	-	50	100	A/μs

2. These ratings are applicable when surface mounted on the minimum pad sizes recommended.
3. 1/8" from case for 10 seconds.
4. Ratings apply for negative gate voltage or  $R_{GK} = 1.0 \text{ k}\Omega$ . Devices shall not have a positive gate voltage concurrently with a negative voltage on the anode. Component should not be tested with a constant current source for forward and reverse blocking capability such that the voltage applied exceeds the rated blocking voltage.
5. Pulse Test: Pulse Width  $\leq 2.0 \text{ msec}$ , Duty Cycle  $\leq 2\%$ .
6.  $R_{GK}$  current not included in measurement.

**Voltage Current Characteristic of SCR**

Symbol	Parameter
$V_{DRM}$	Peak Repetitive Forward Off State Voltage
$I_{DRM}$	Peak Forward Blocking Current
$V_{RRM}$	Peak Repetitive Reverse Off State Voltage
$I_{RRM}$	Peak Reverse Blocking Current
$V_{TM}$	Maximum On State Voltage
$I_H$	Holding Current

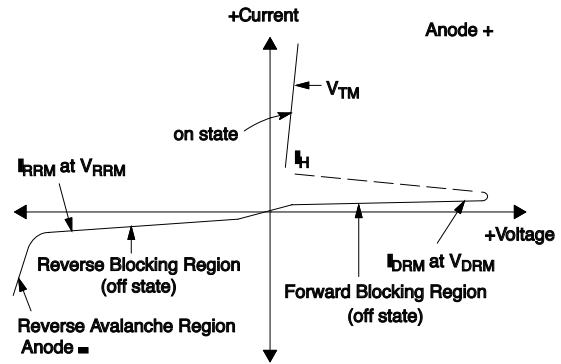

**Figure 1. Average Current Derating**

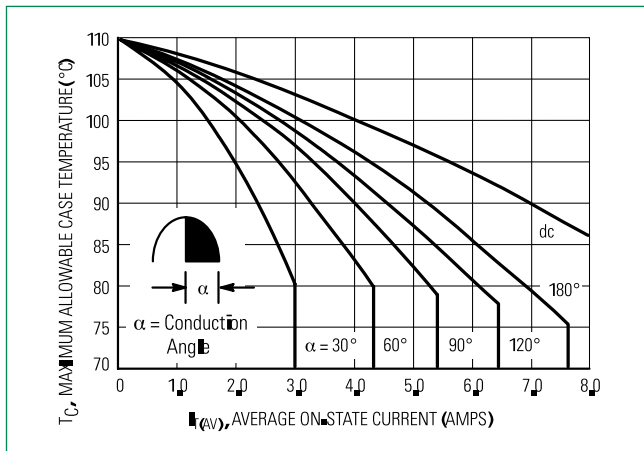

**Figure 2. On-State Power Dissipation**

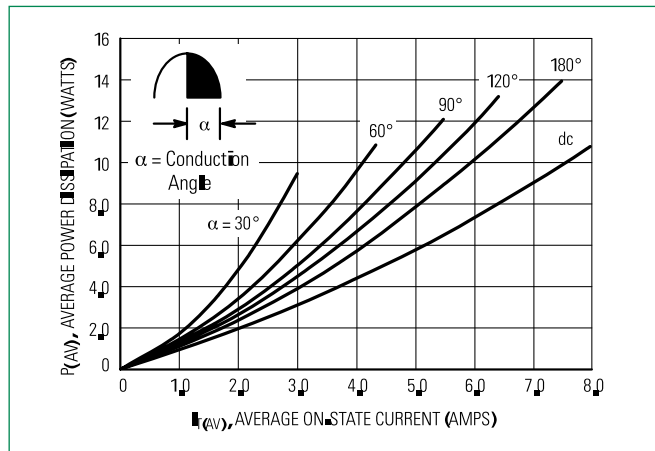

**Figure 3. On-State Characteristics**

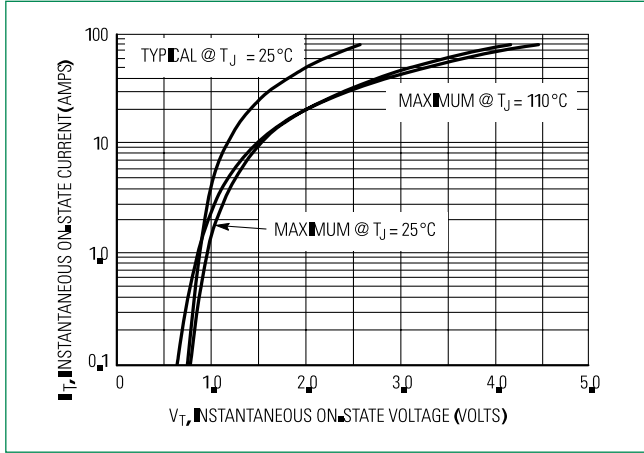

**Figure 4. Transient Thermal Response**

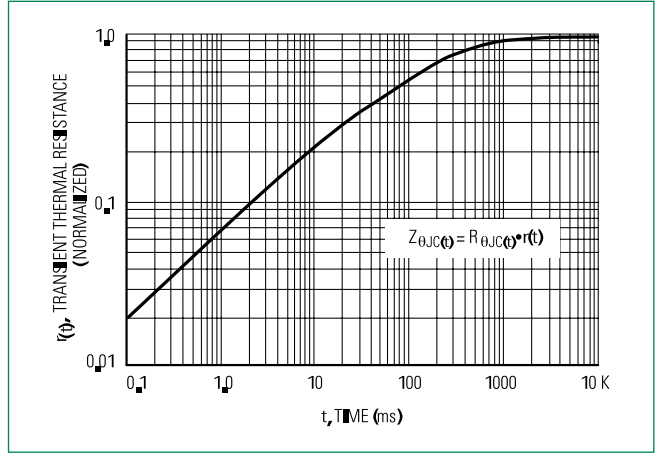

**Figure 5. Typical Gate Trigger Current vs. Junction Temperature**

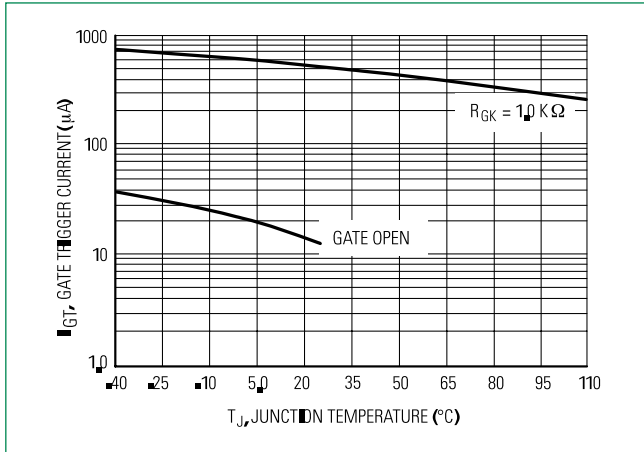

**Figure 6. Typical Gate Trigger Voltage vs. Junction Temperature**

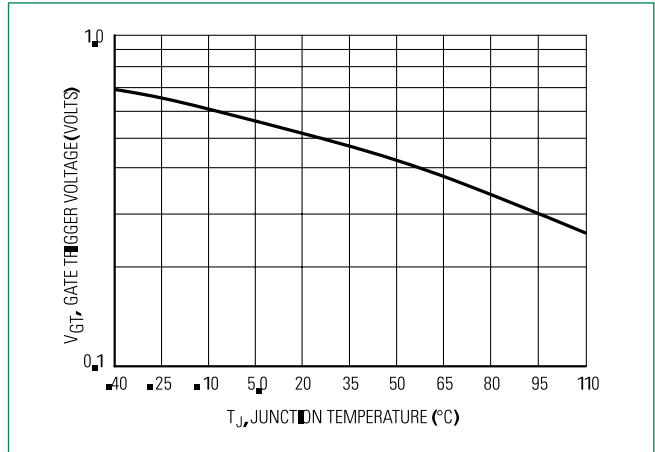

**Figure 7. Typical Holding Current vs. Junction Temperature**

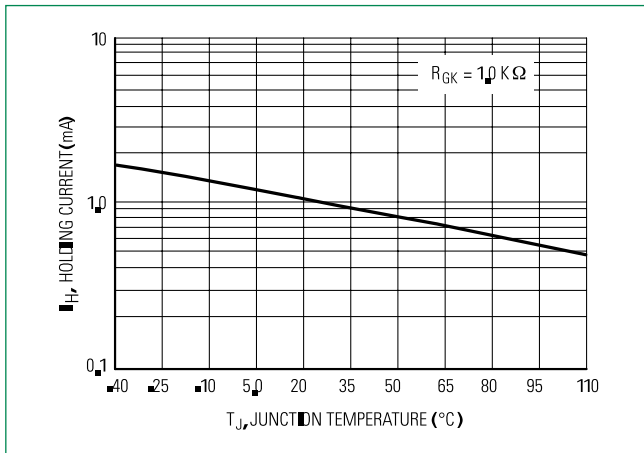

**Figure 8. Typical Latching Current vs. Junction Temperature**

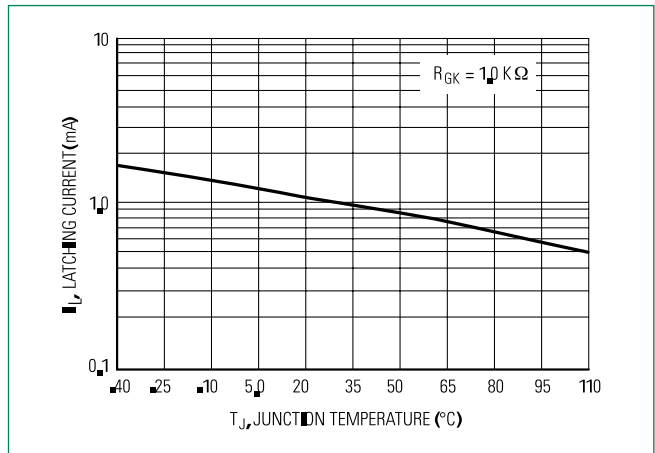

**Figure 9. Holding Current vs Gate-Cathode Resistance**

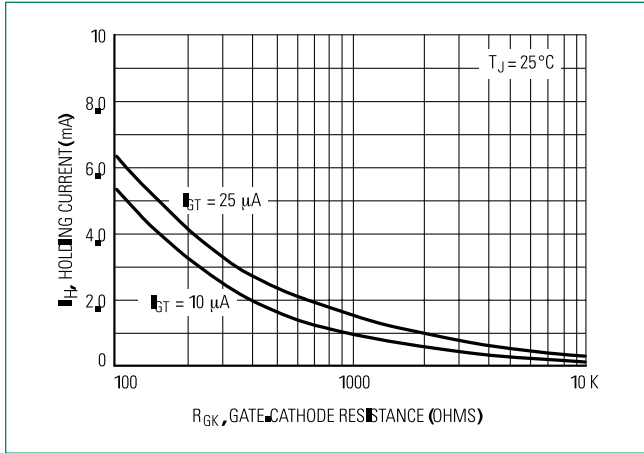

**Fig. 10 Exponential Static dv/dt vs Gate-Cathode Resistance & Junction Temp**

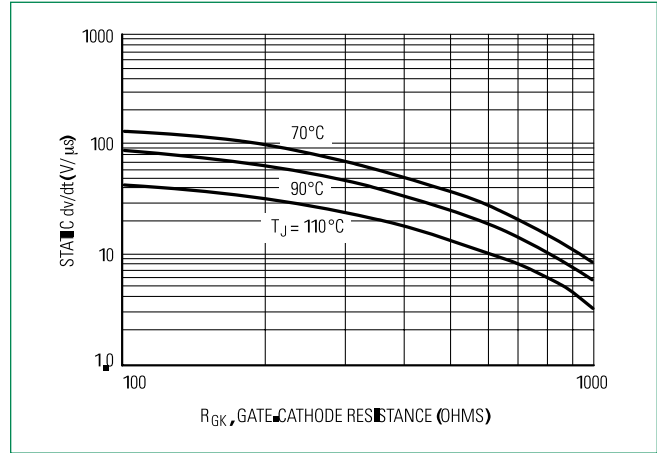

**Figure 11. Typical Gate Trigger Current vs Junction Temperature**

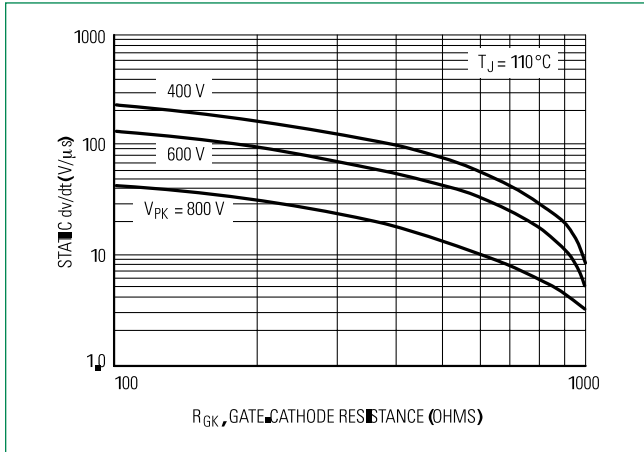

**Figure 12. Typical Gate Trigger Voltage vs Junction Temperature**

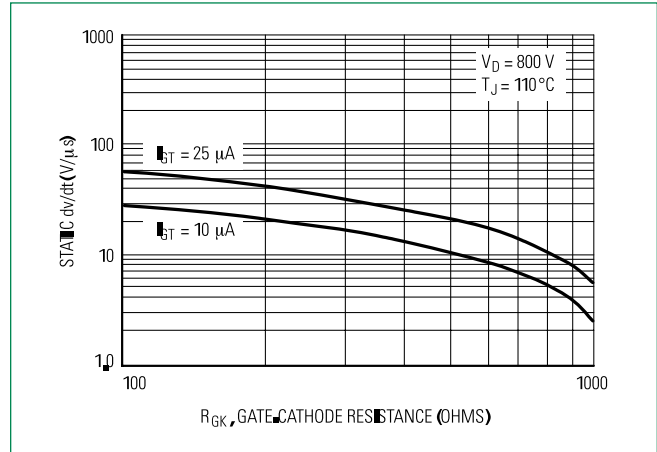

### Dimensions

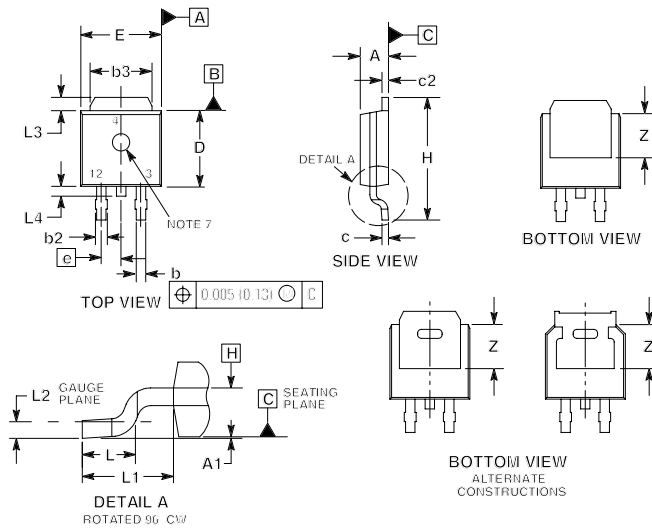

### Soldering Footprint

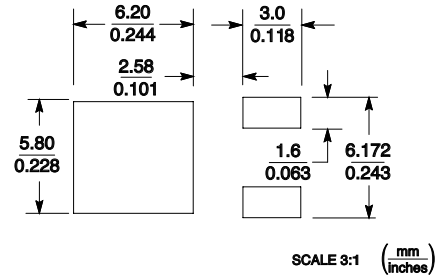

Dim	Inches		Millimeters	
	Min	Max	Min	Max
A	0.087	0.094	2.20	2.40
A1	0.000	0.005	0.00	0.12
b	0.022	0.030	0.55	0.75
b2	0.026	0.033	0.65	0.85
b3	0.209	0.217	5.30	5.50
c	0.019	0.023	0.49	0.59
c2	0.019	0.023	0.49	0.59
D	0.213	0.224	5.40	5.70
E	0.252	0.260	6.40	6.60
e	0.091		2.30	
H	0.374	0.406	9.50	10.30
L	0.058	0.070	1.47	1.78
L1	0.114		2.90	
L2	0.019	0.023	0.49	0.59
L3	0.053	0.065	1.35	1.65
L4	0.028	0.039	0.70	1.00
Z	0.154	-	3.90	-

- DIMENSIONING AND TOLERANCING PER ASME Y14.5M, 1994.
- CONTROLLING DIMENSION: INCH.
- THERMAL PAD CONTOUR OPTIONAL WITHIN DIMENSIONS b3, L3 and Z.
- DIMENSIONS D AND E DO NOT INCLUDE MOLD FLASH, PROTRUSIONS, OR BURRS. MOLD FLASH, PROTRUSIONS, OR GATE BURRS SHALL L3 Z NOT EXCEED 0.006 INCHES PER SIDE.
- DIMENSIONS D AND E ARE DETERMINED AT THE OUTERMOST EXTREMES OF THE PLASTIC BODY.
- DATUMS A AND B ARE DETERMINED AT DATUM PLANE H.

### Dimensions

**DPAK**  
**CASE 369D**  
**ISSUE C**

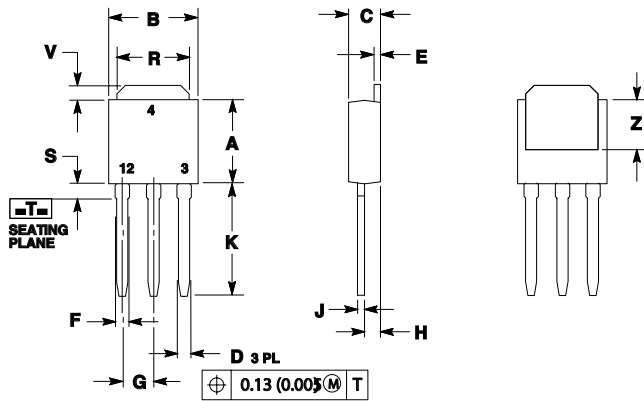

Dim	Inches		Millimeters	
	Min	Max	Min	Max
A	0.213	0.224	5.40	5.70
B	0.252	0.260	6.40	6.60
C	0.087	0.094	2.20	2.40
D	0.024	0.030	0.60	0.75
E	0.022	0.026	0.55	0.65
F	0.031	0.039	0.78	0.98
G	0.091		2.30	
H	0.046	0.050	1.18	1.28
J	0.019	0.023	0.49	0.59
K	0.291	0.315	7.40	8.00
R	0.209	0.217	5.30	5.50
S	0.063		1.60	
V	0.053	0.065	1.35	1.65
Z	0.150		3.80	

1. DIMENSIONING AND TOLERANCING PER ANSI Y14.5M, 1982.
2. CONTROLLING DIMENSION: INCH.

### Part Marking System



Y= Year  
WW = Work Week  
R12DSx = Device Code  
x= M or N  
G= Pb-Free Package

### Pin Assignment

Pin	Assignment
1	Cathode
2	Anode
3	Gate
4	Anode

### Ordering Information

Device	Package Type	Package	Shipping
MCR12DSMT4G	DPAK	369C	2500 Tape & Reel
MCR12DSN-1G	IPAK	369D	4000 Units/Box
MCR12DSNT4G	DPAK	369C	2500 Tape & Reel

**Disclaimer Notice** - Information furnished is believed to be accurate and reliable. However, users should independently evaluate the suitability of and test each product selected for their own applications. Littelfuse products are not designed for, and may not be used in, all applications. Read complete Disclaimer Notice at: [www.littelfuse.com/disclaimer-electronics](http://www.littelfuse.com/disclaimer-electronics)