

SPECIFICATION

Part No.	:	TG.22.0112
Product Name	:	Penta-Band Cellular Connector Mount Monopole Helical GSM-DCS-PCS-UMTS-CDMA-GPRS-EDGE-HSPA 824MHz ~2170 MHz
Features	:	2.5dBi Gain SMA(M) Fixed Right Angle plug, 50 Ohms ROHS Compliant
Photo	:	



1. Introduction

The TG.22.0112 Penta-band GSM-DCS-PCS-UMTS-CDMA-GPRS-EDGE-HSPA 824MHz to 2170MHz monopole helical antenna is a quality robust antenna with high gain in small form factor.

Connection is made via fixed right angle SMA(M) connector with a hardened waterproof PU casing, this antenna is the ideal GSM antenna for telematics devices.

2. Antenna Performance

2.1 Electrical Specifications

Parameter	Specification				
Bands	GSM850	GSM900	DCS	PCS	WCDMA I
Frequency Range	824~896MHz	880~960MHz	1710~1880MHz	1850~1990MHz	1920~2170MHz
Return Loss	≤-5dB				
VSWR	≤3.5				
Peak Gain	1.49dBi	1.93dBi	2.37dBi	2.58dBi	2.23dBi
Efficiency	66.24%	70.86%	70.47%	68.87%	65.40%
Average Gain	-1.81dBi	-1.50dBi	-1.52dBi	-1.63dBi	-1.89dBi
Polarization	Linear				
Power handling	20 W				
Impedance	50 Ohms				
Connector	SMA(M) Right Angle				

*All the antenna characteristics were measured with 150mm*90mm ground plane

2.2 Environmental & Mechanical Characteristics

Parameter	Specification
Temperature	-40°C to +85°C
Radome Colour	Black
Radome Material	TPEE
Weight	6g

3. TEST SET UP



Figure 1. Impedance and VSWR measurements

4. Performance Measurements

4.1 Return Loss

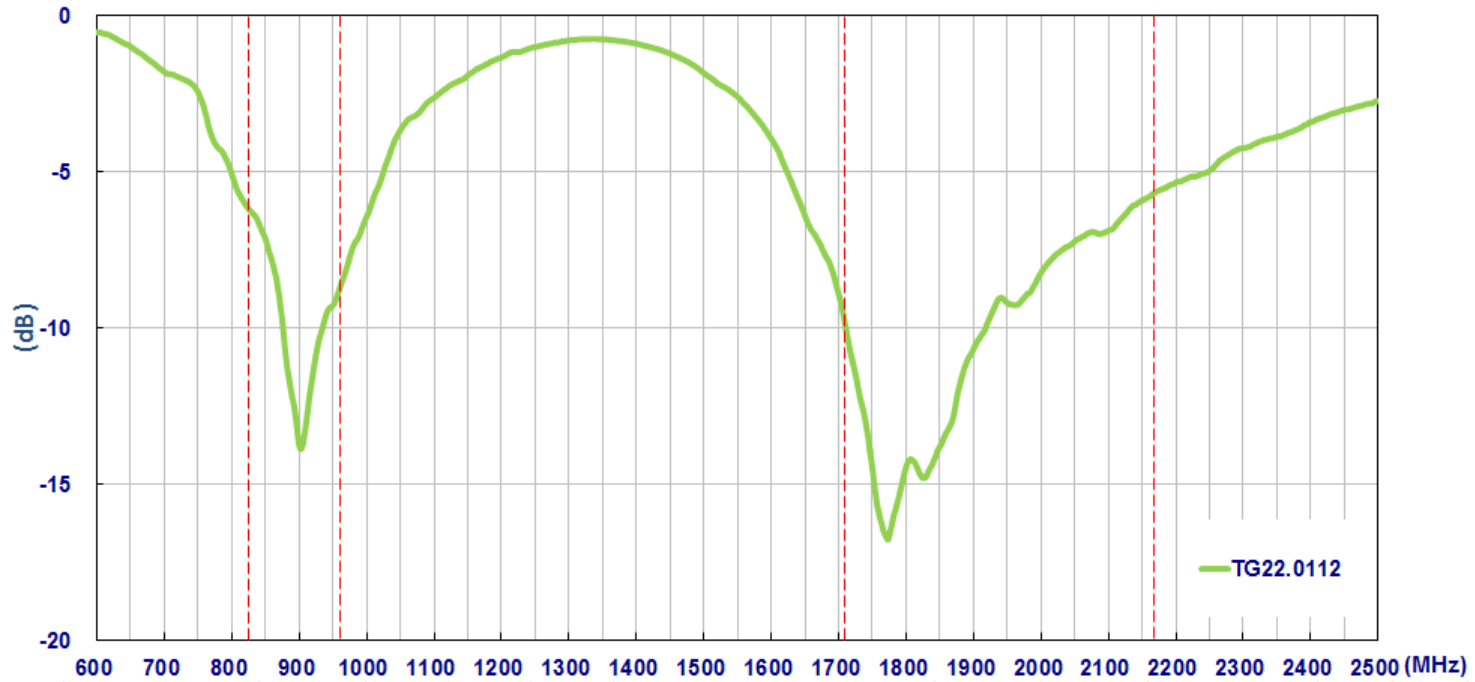

Figure 2. Return Loss of TG.22.0112

4.2 VSWR

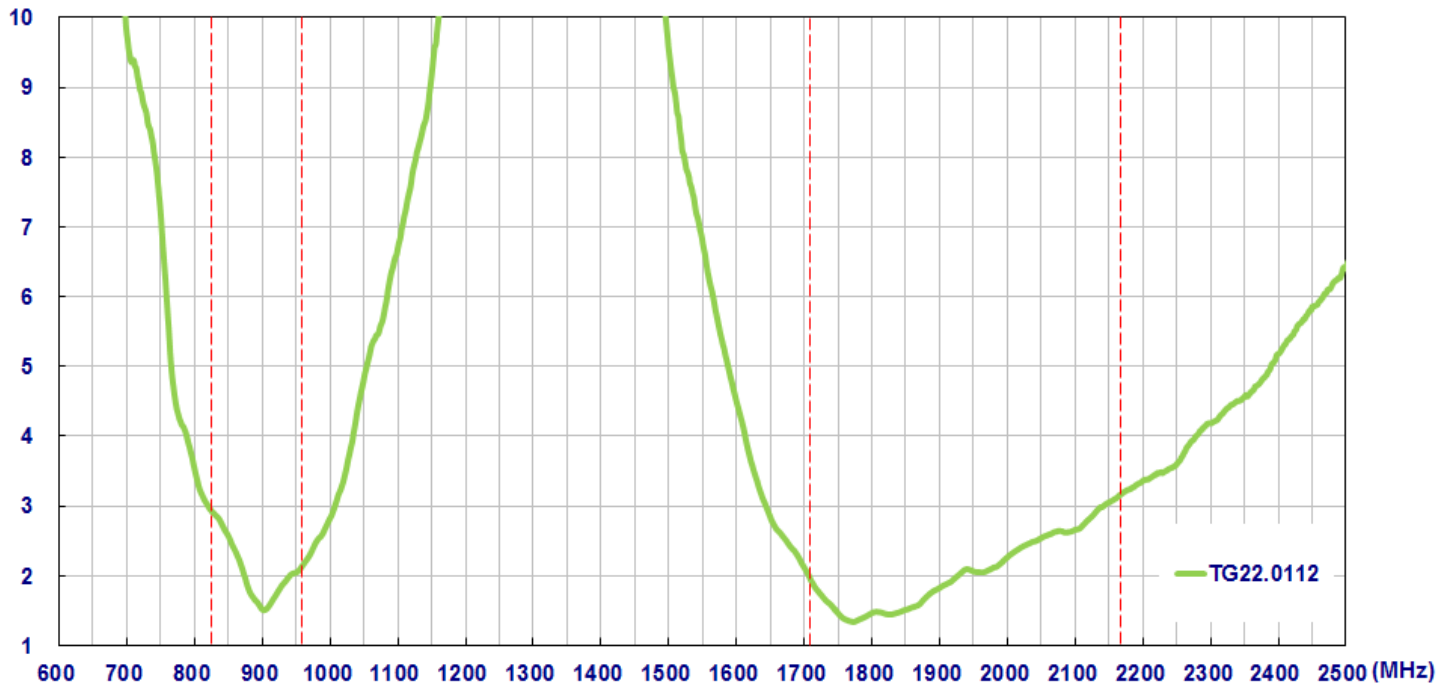

Figure 3. VSWR of TG.22.0112

4.3 Efficiency (%)

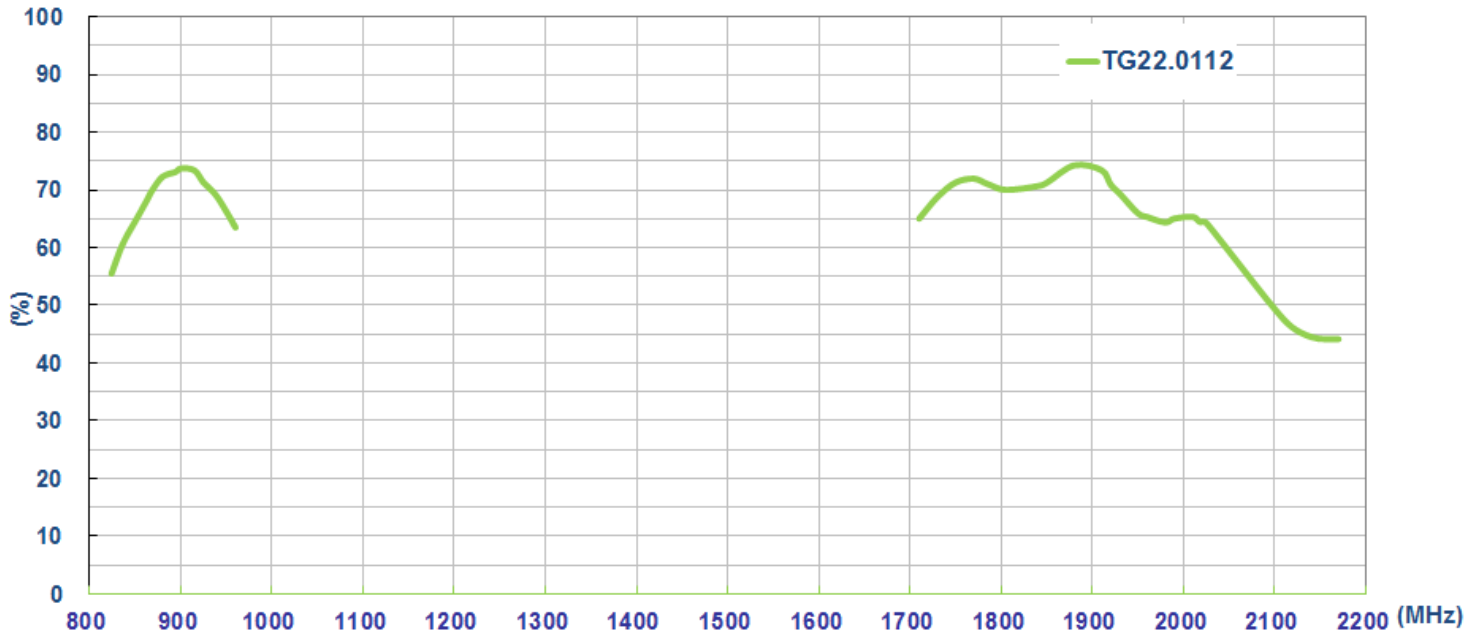

Figure 4. Efficiency of TG.22.0112

4.4 Peak Gain(dBi)

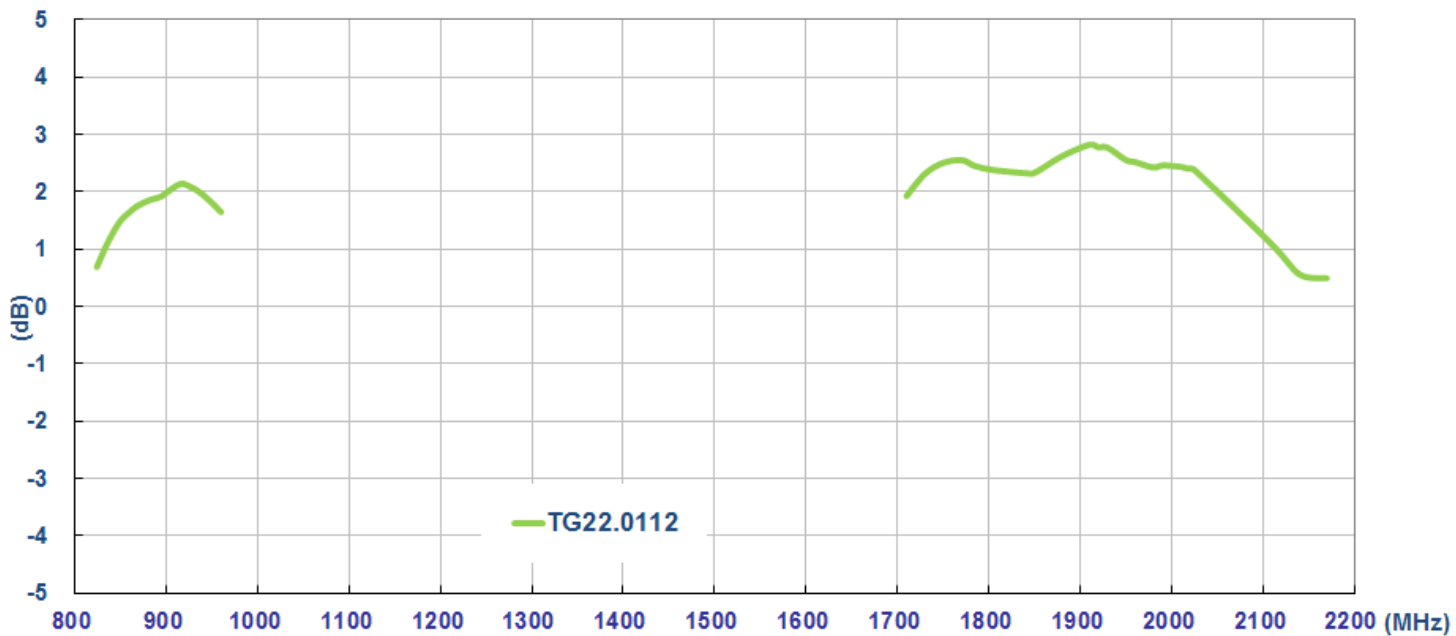

Figure 5. Peak Gain of TG.22.0112

4.5 Average Gain(dBi)

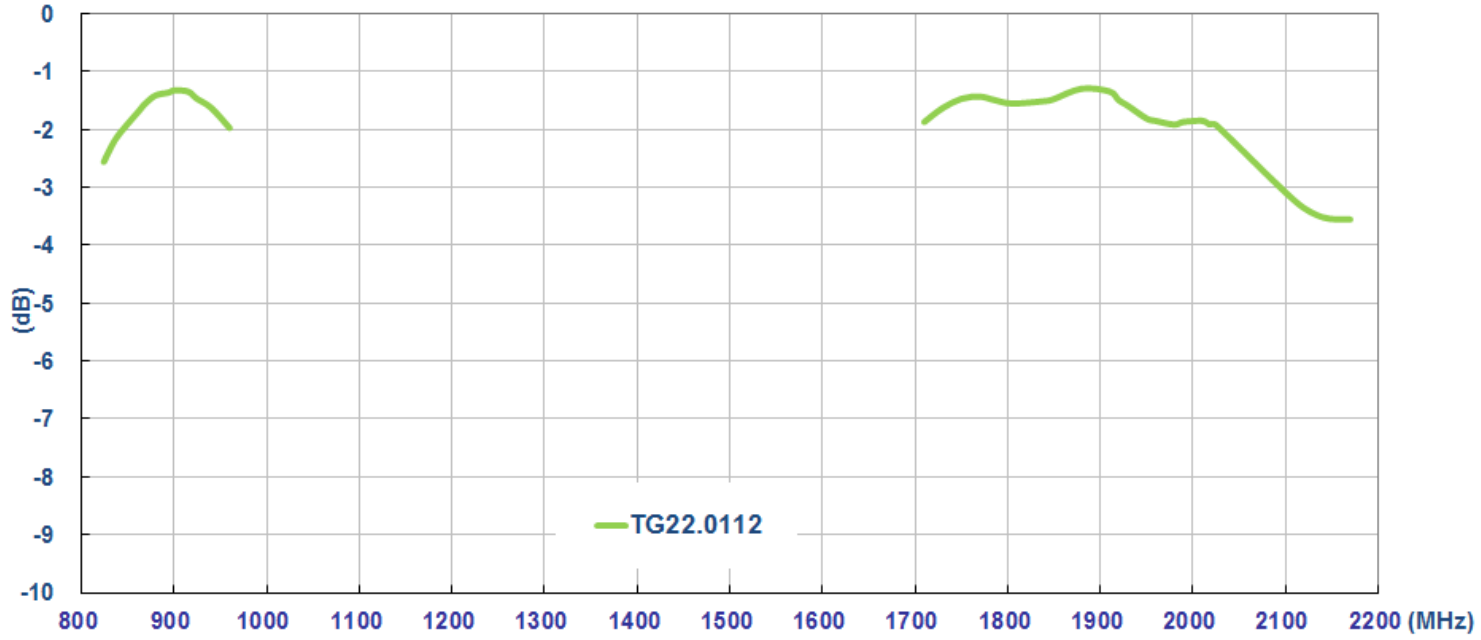
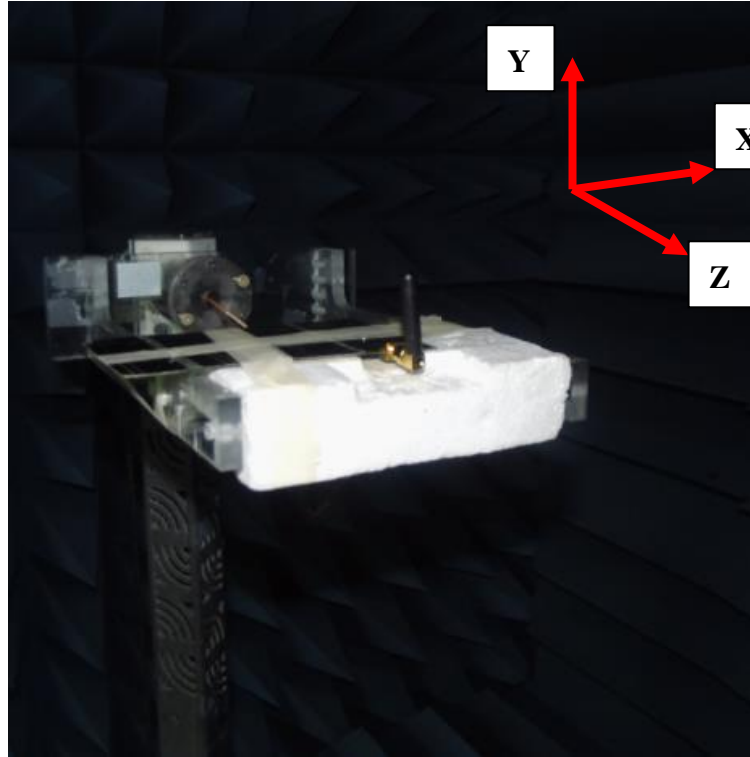

Figure 6. Average Gain of TG.22.0112

4.6 Radiation Pattern Data



4.6.1 Radiation Pattern

XY-Plane

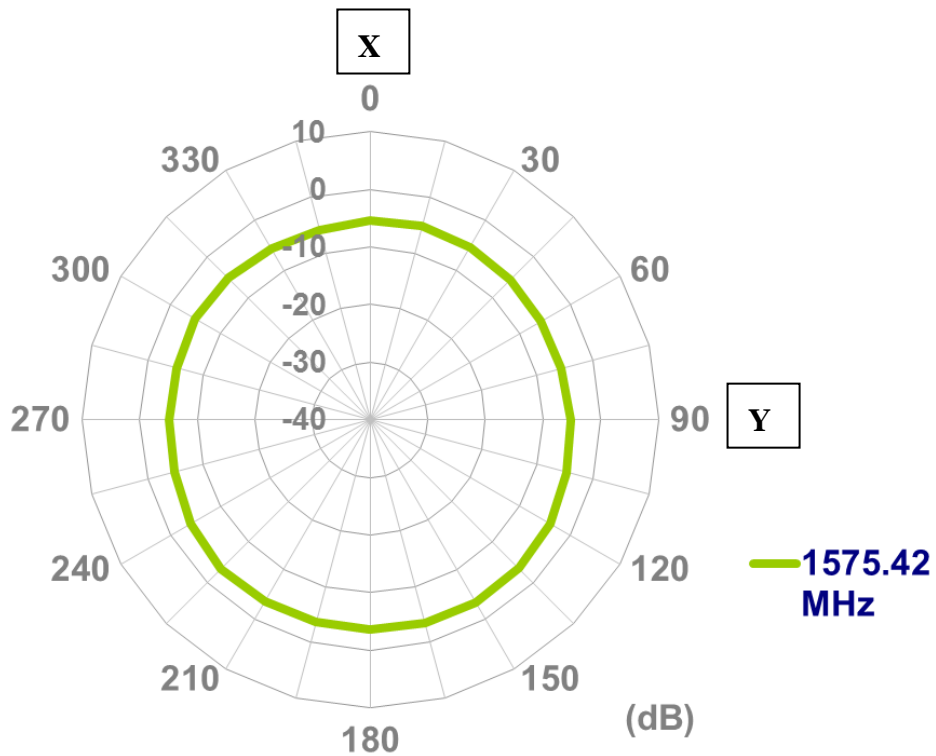
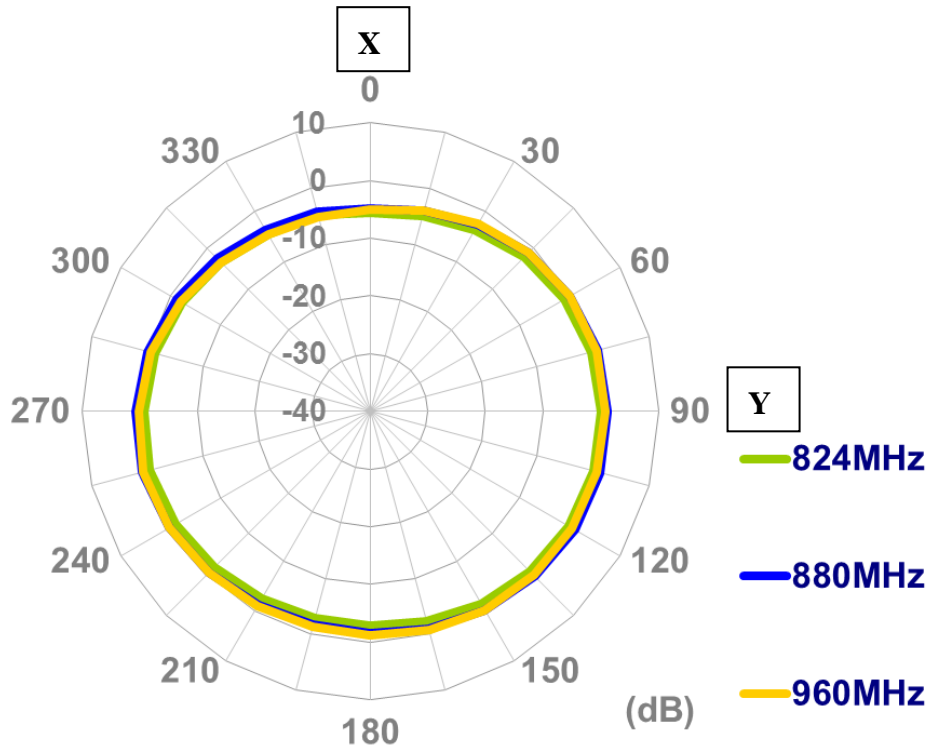

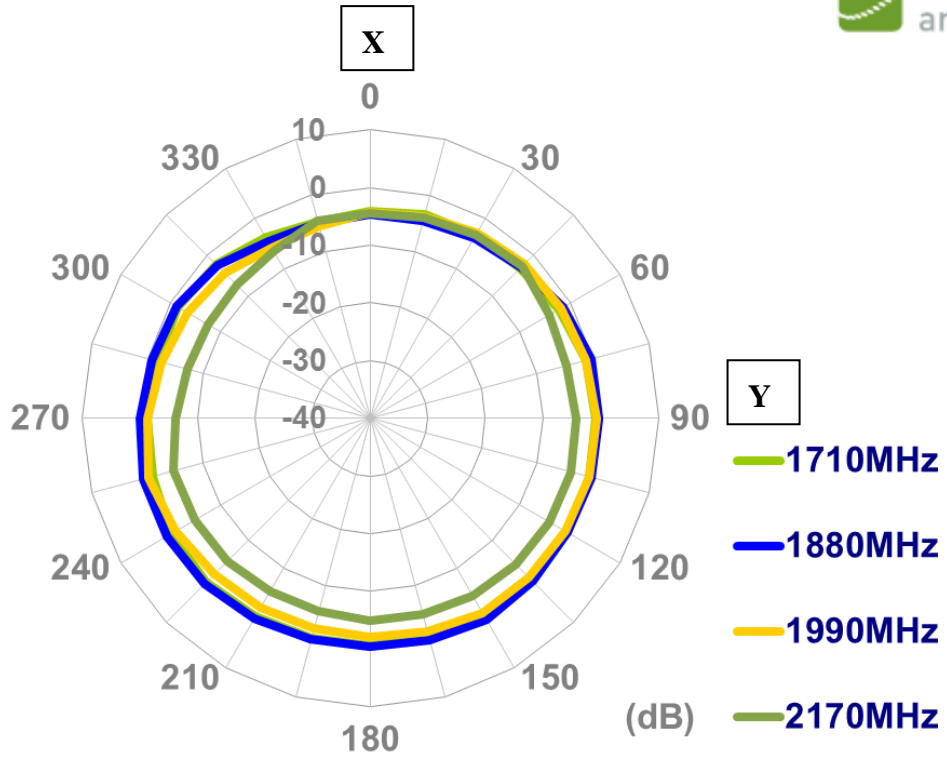

XZ-Plane

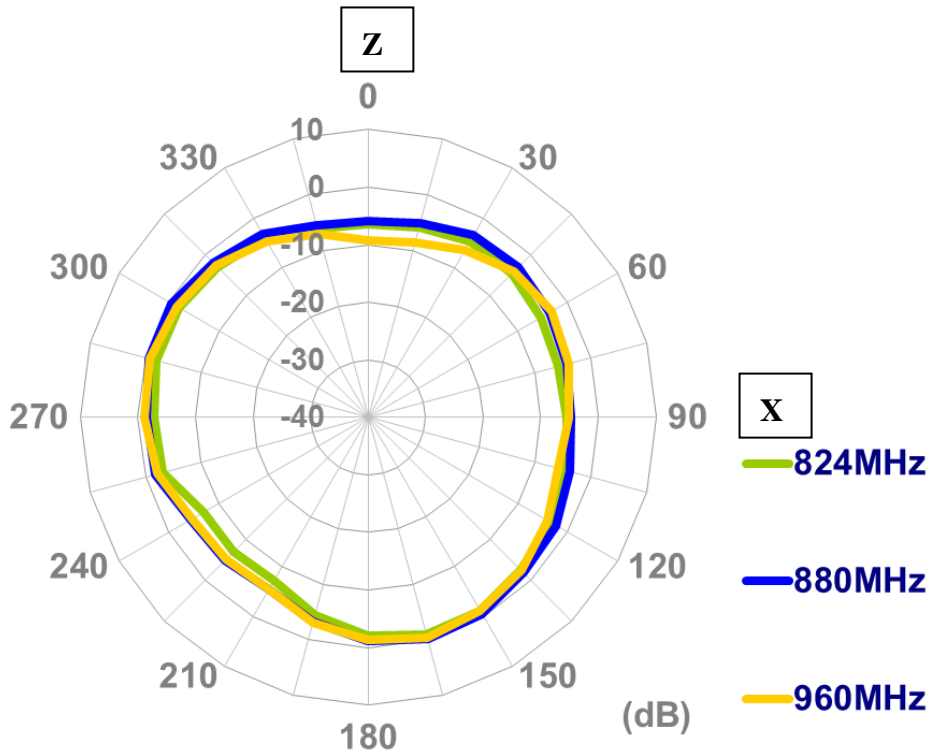

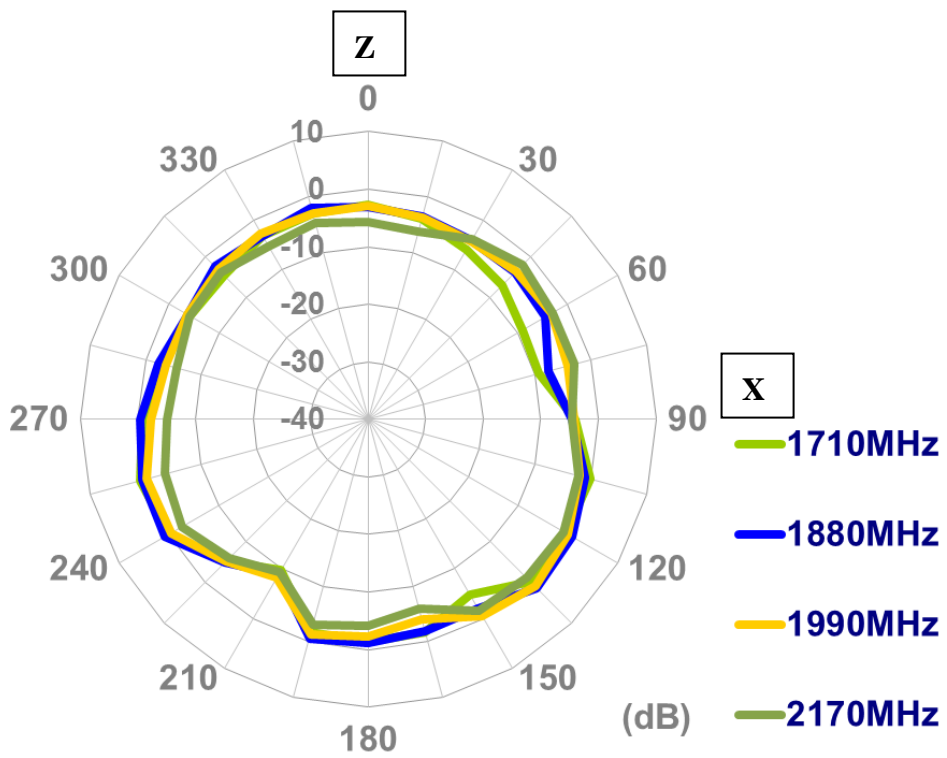
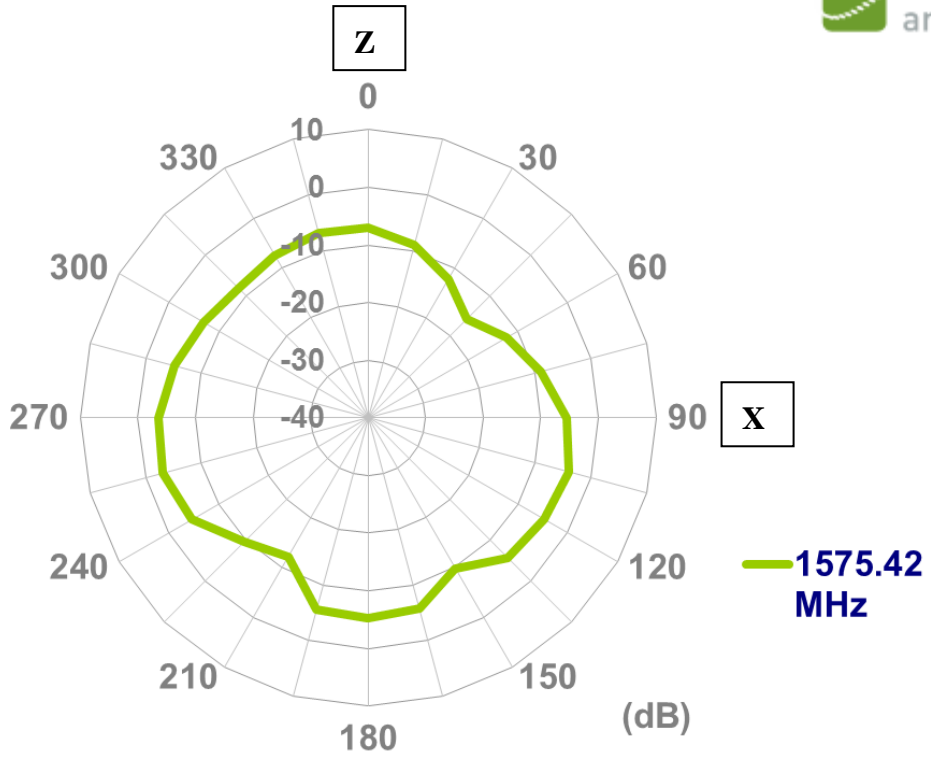

YZ-Plane

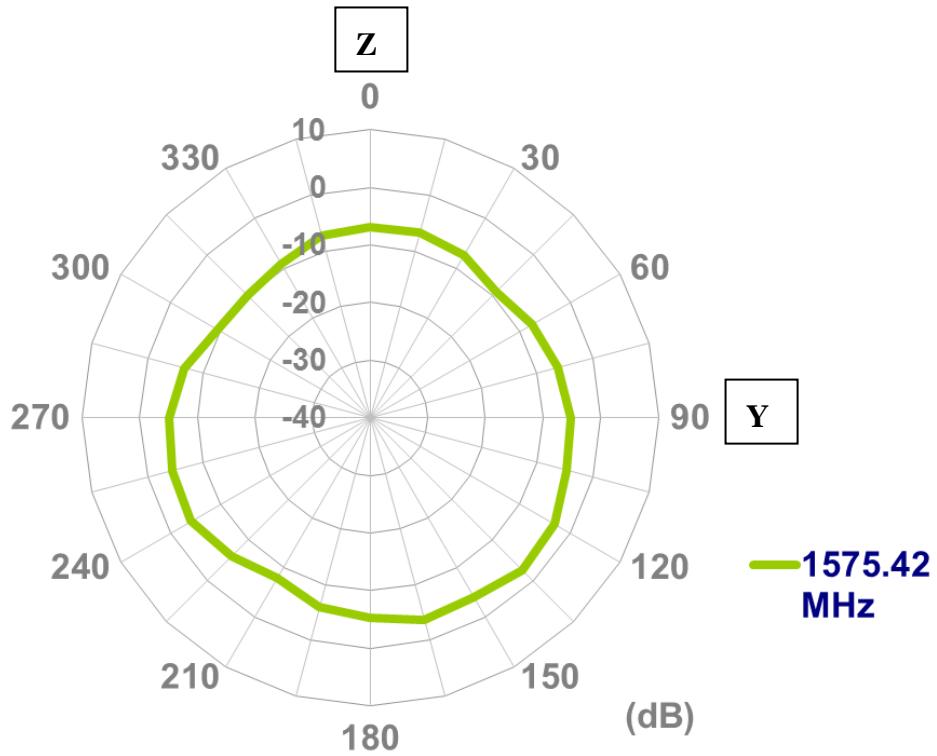
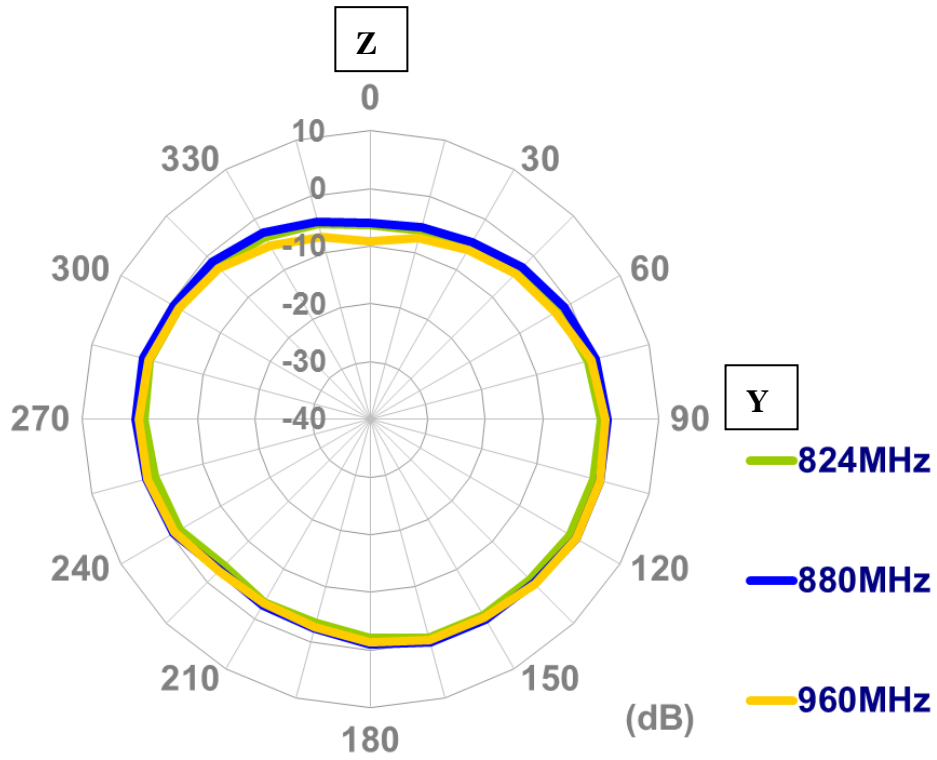

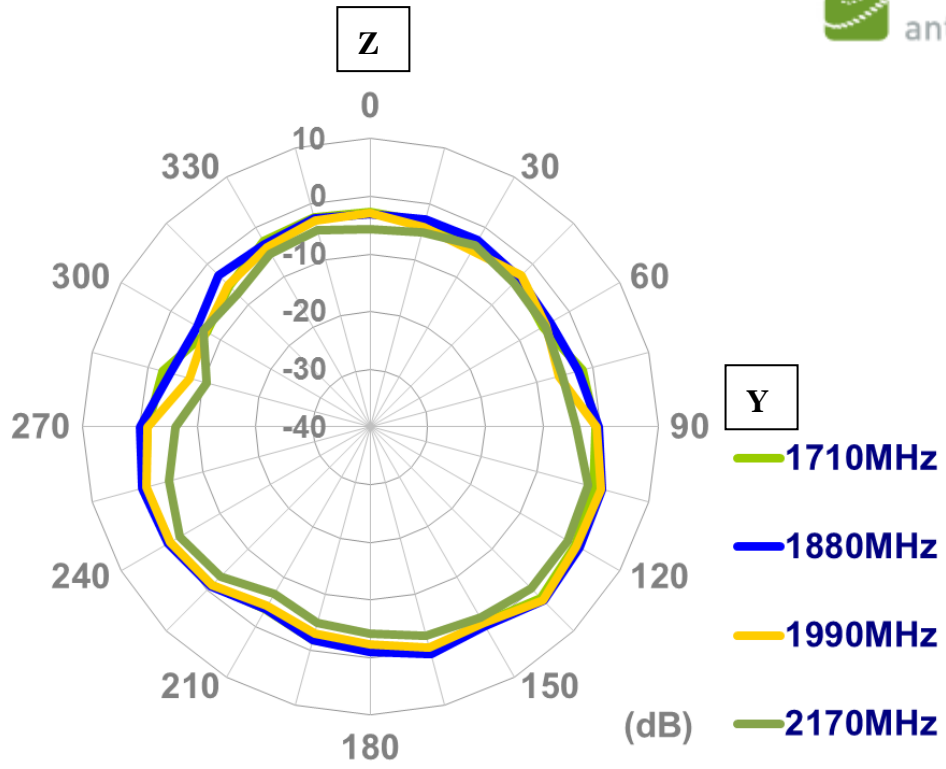

5. Mechanical Drawing

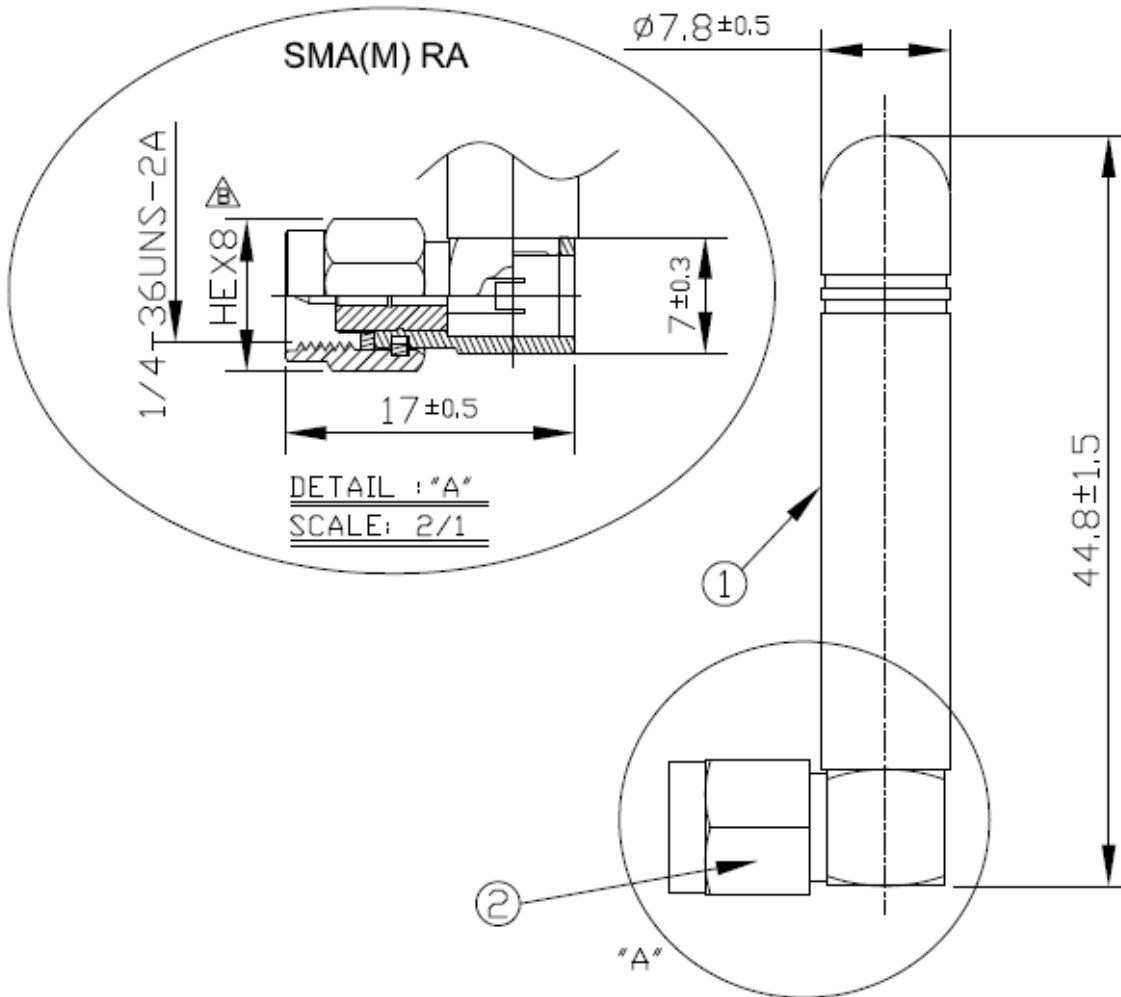

	Name	P/N	Material	Finish	QTY
①	Antenna Housing	000111F030002A	TPEE	Black	1
②	SMA(M) RA	210211G010002A	Brass	Gold	1

unit:mm

6. Packaging

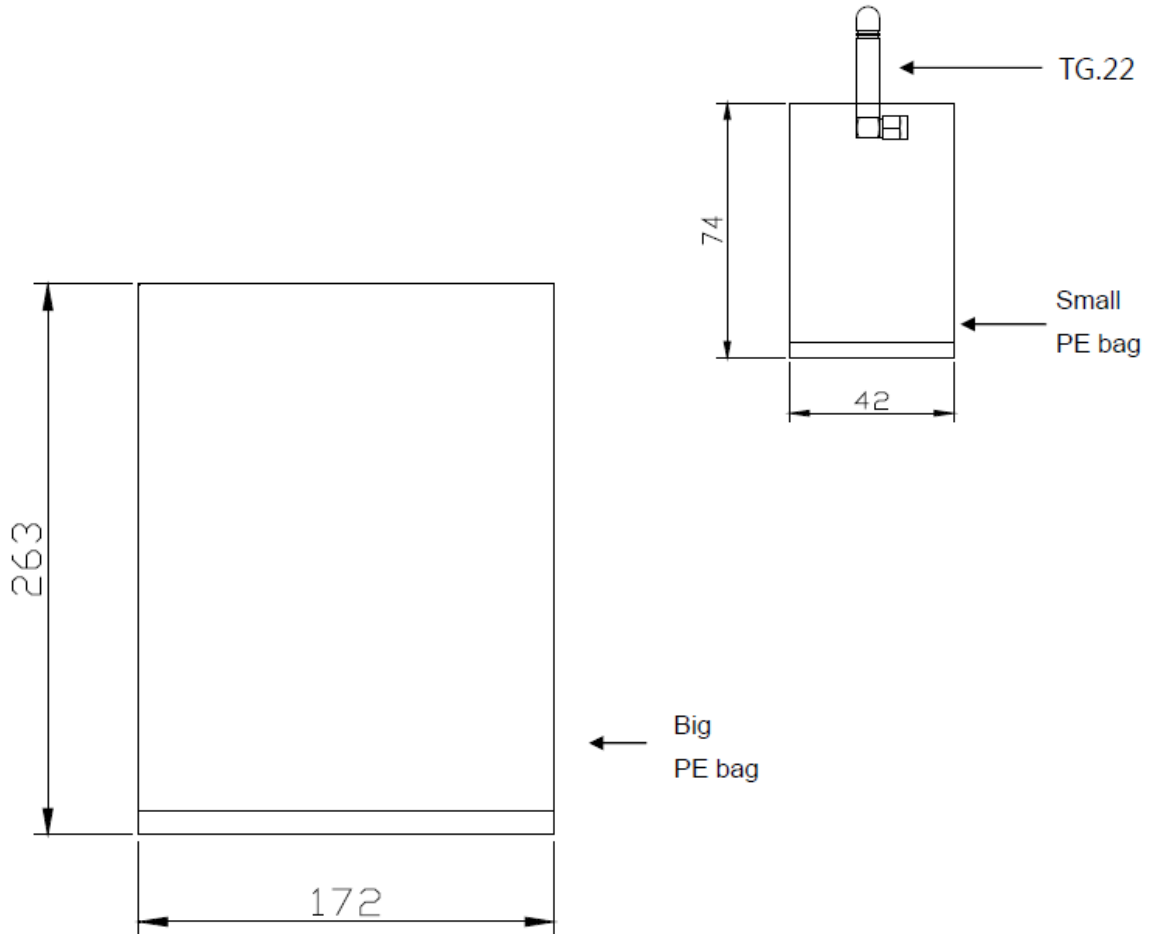

1pcs antennas per small PE bag.

100 small PE bags per big PE bag.

100pcs antennas per big sealed PE bag.

7. Installation

- 1) Use hand to screw the SMA connector.
Tighten it until it feels a little tight.



- 2) Use torque wrench which has 0.9 Nm torque limit to tighten it.



- 3) Do not use normal wrench.



8. Application Note

This section, Taoglas provides the ground variation effects to TG.22.0112 antenna. Detail setup is setup as below.

Ground Plane Dimensions:

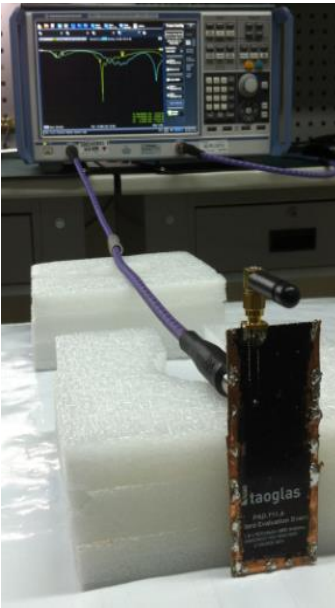

10cm*4cm



20cm*20cm



30cm*30cm



40cm*40cm



50cm*50cm edge

Return Loss:

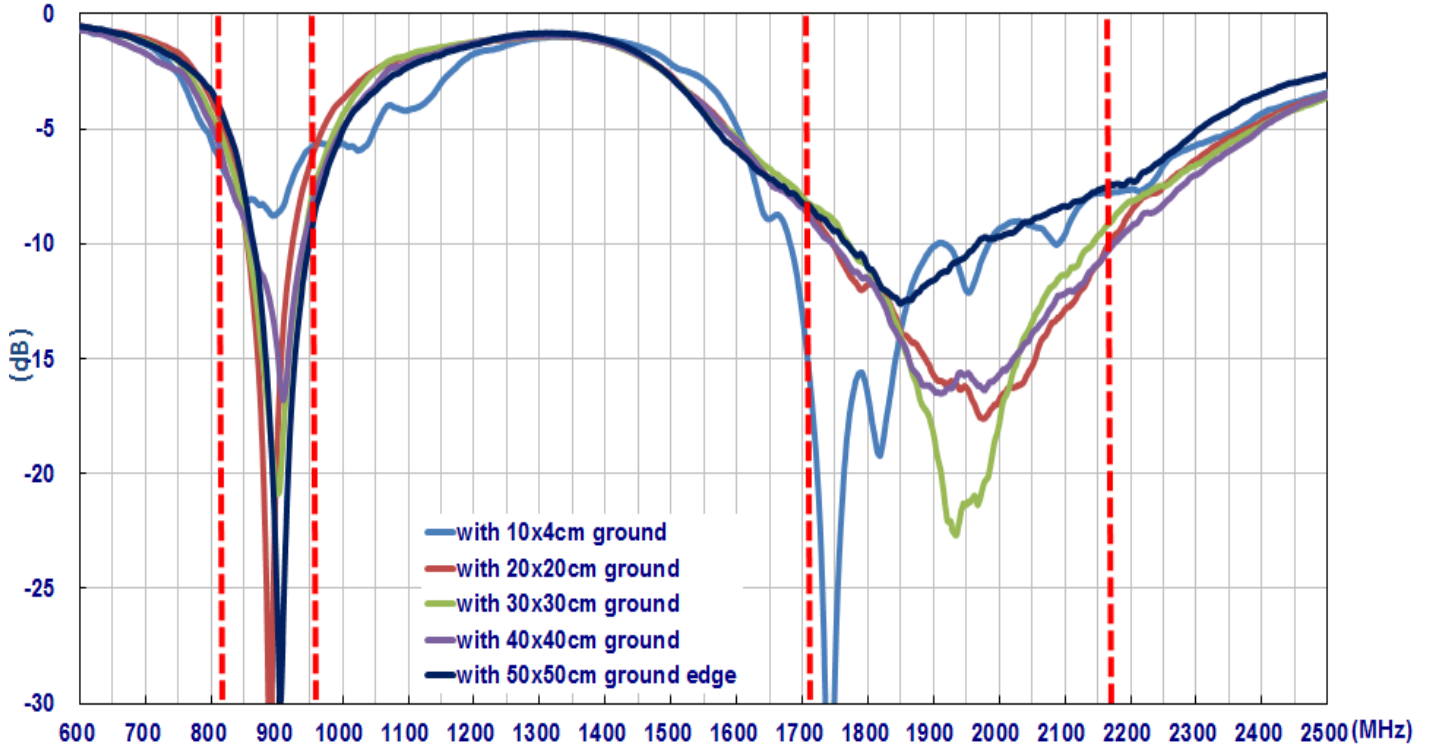

Efficiency:

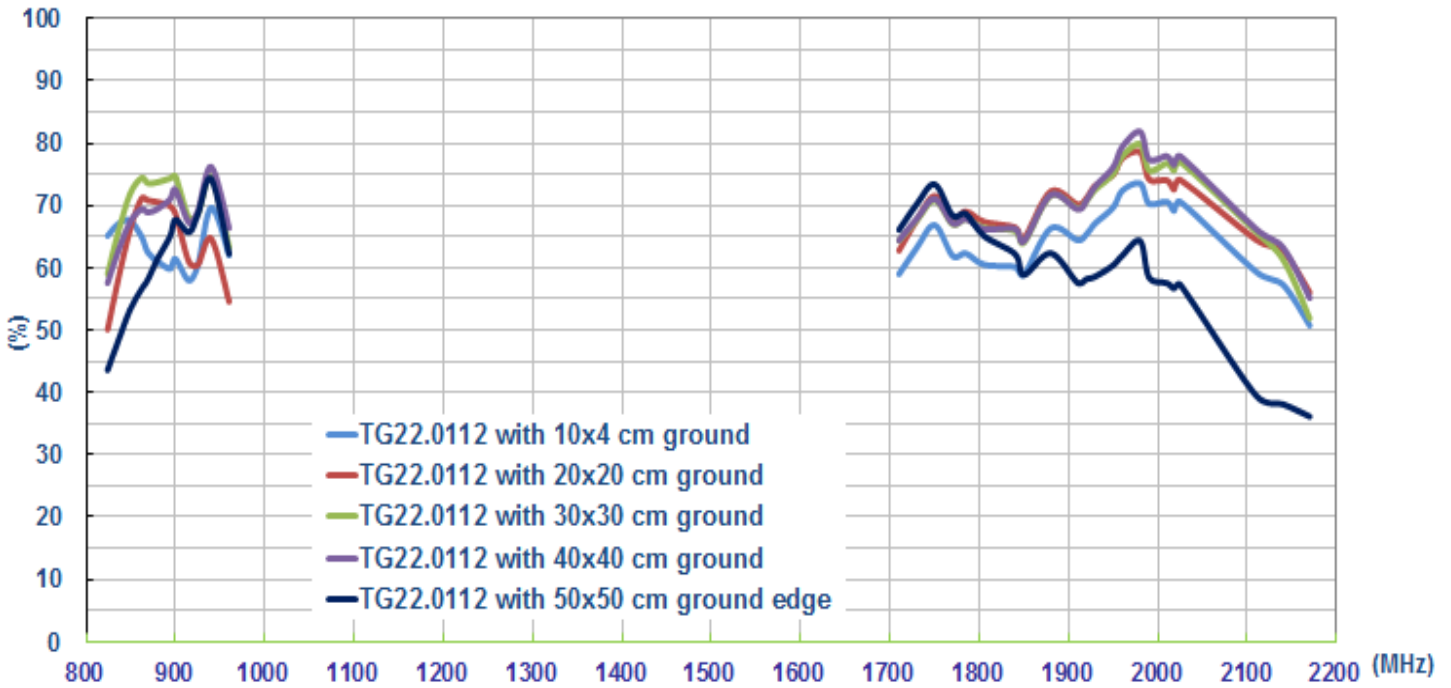

Peak Gain:

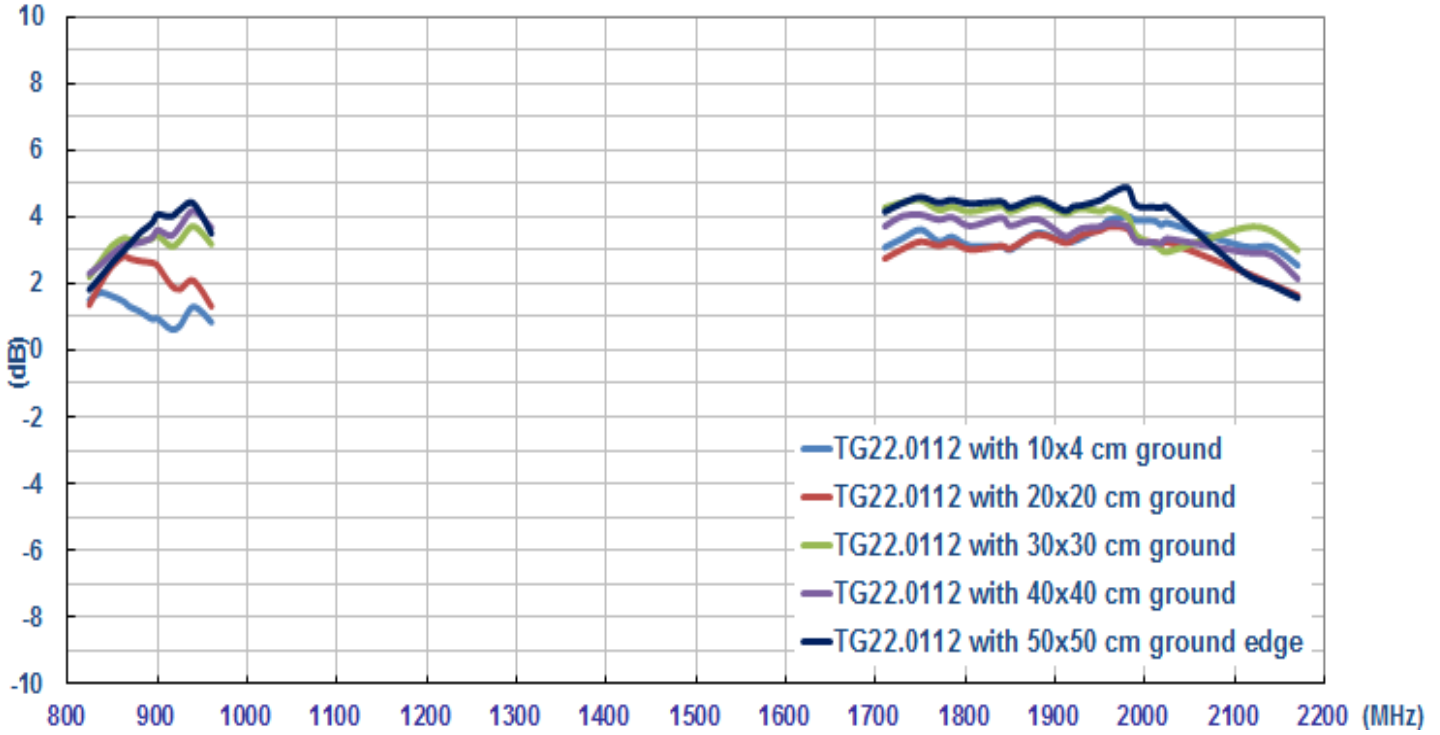

Radiation Pattern Measurement Setup:

10cm*4cm Ground Plane

Setup

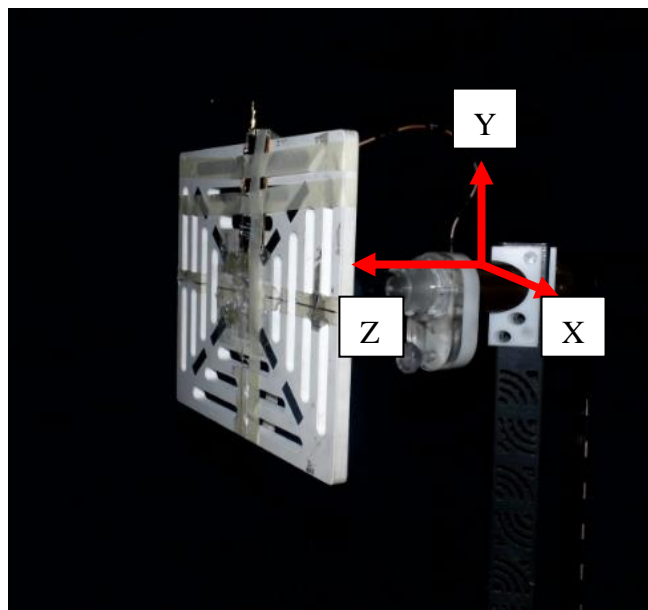

XY-Plane

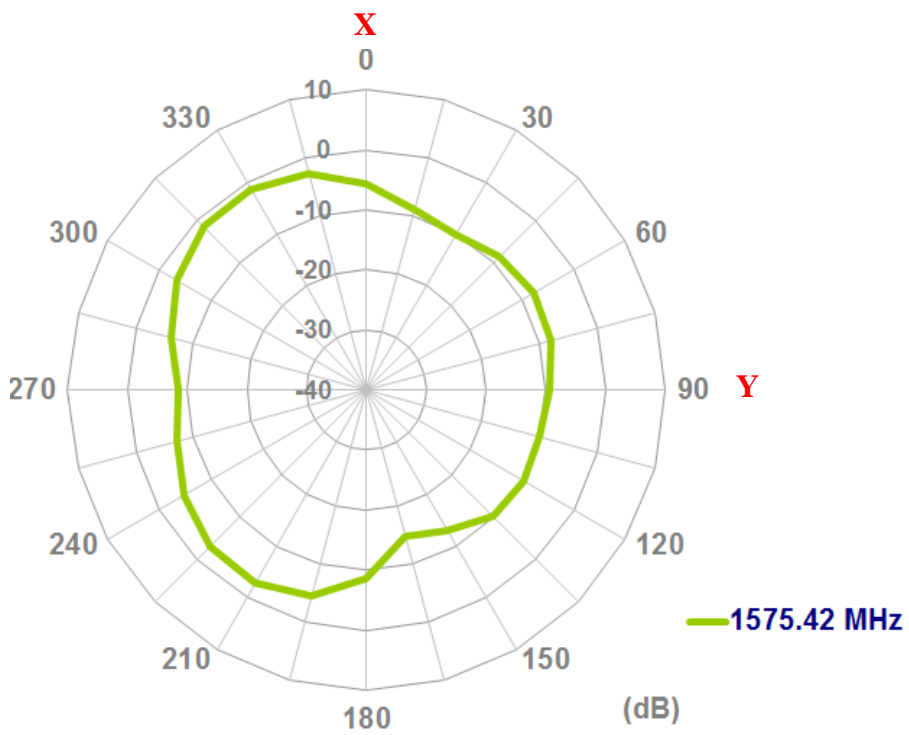
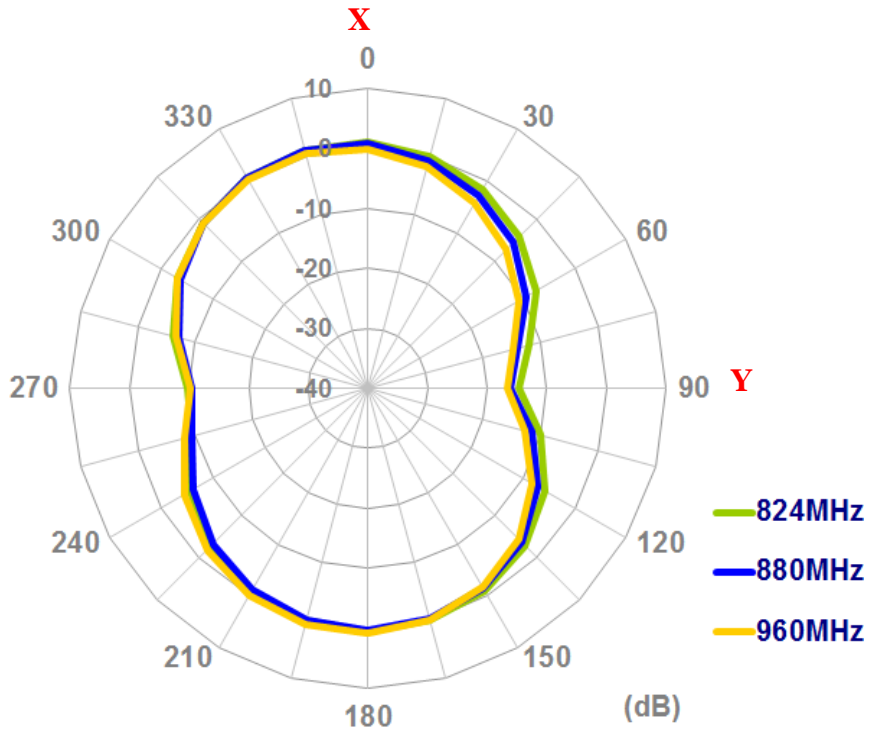

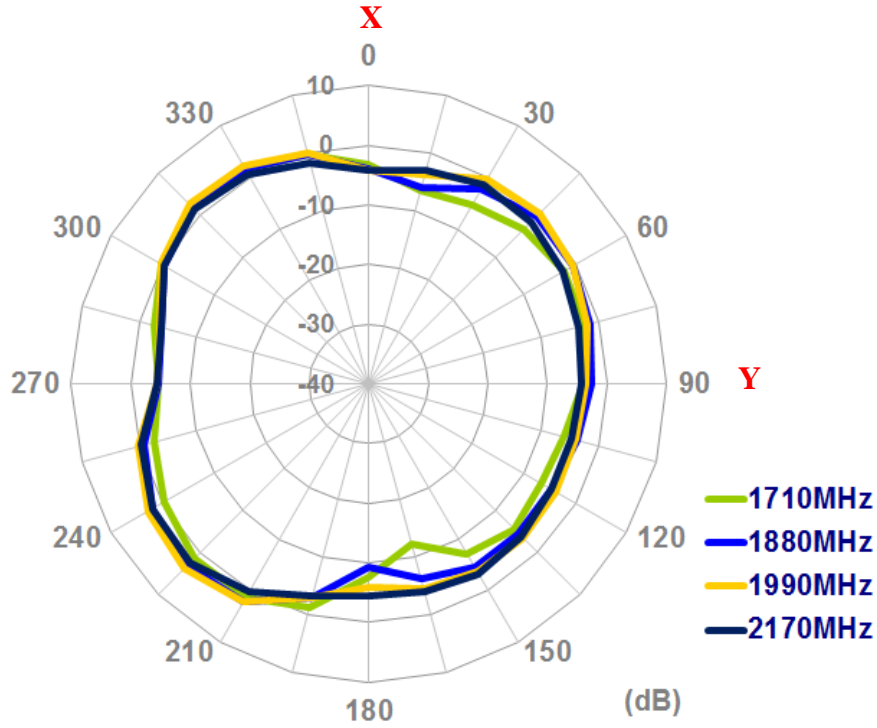

XZ-Plane

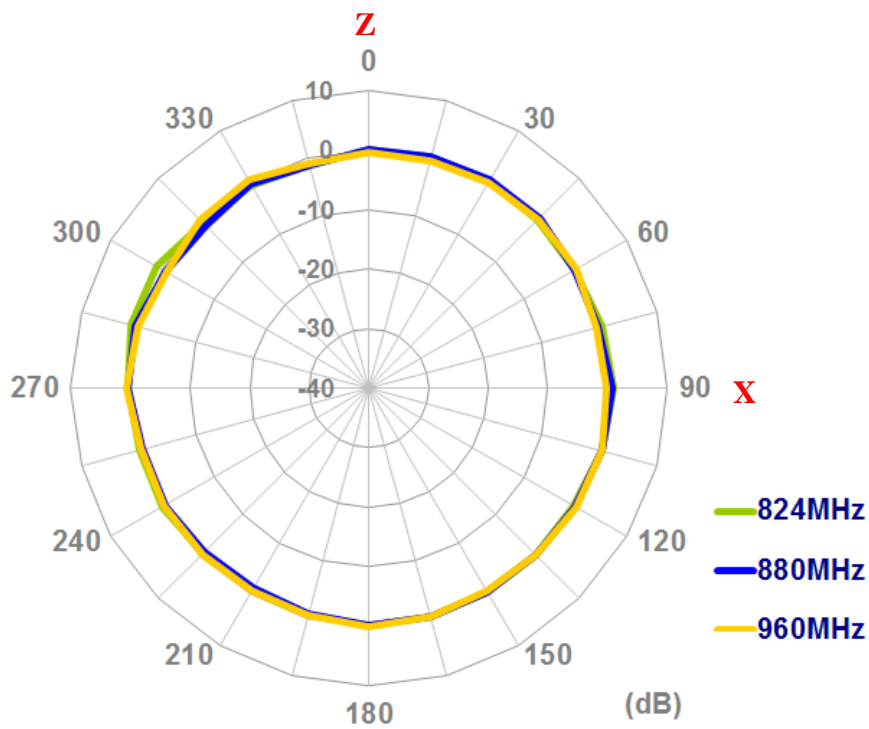

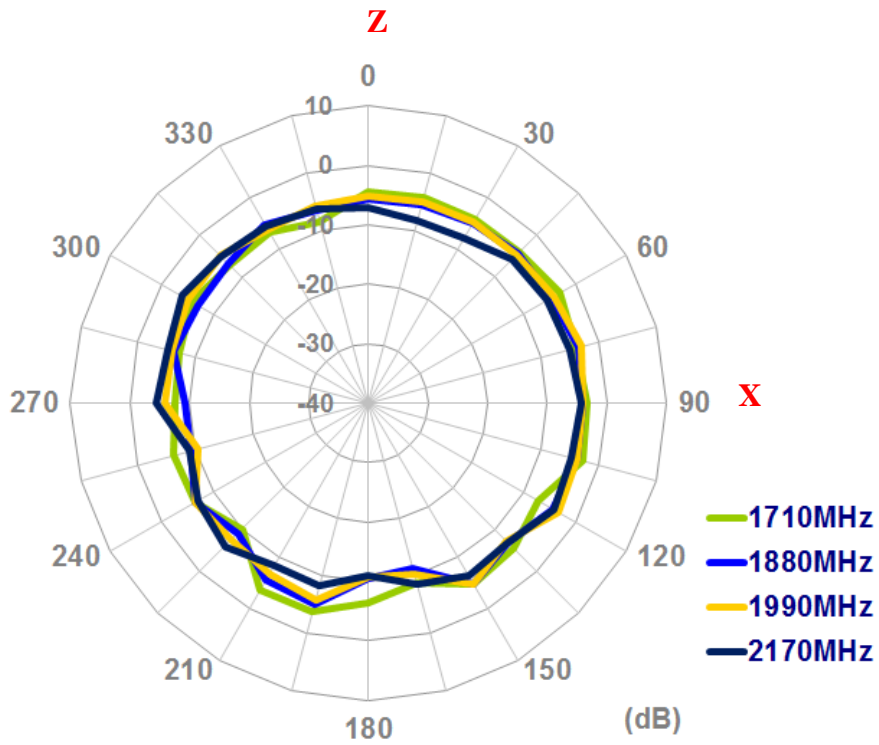
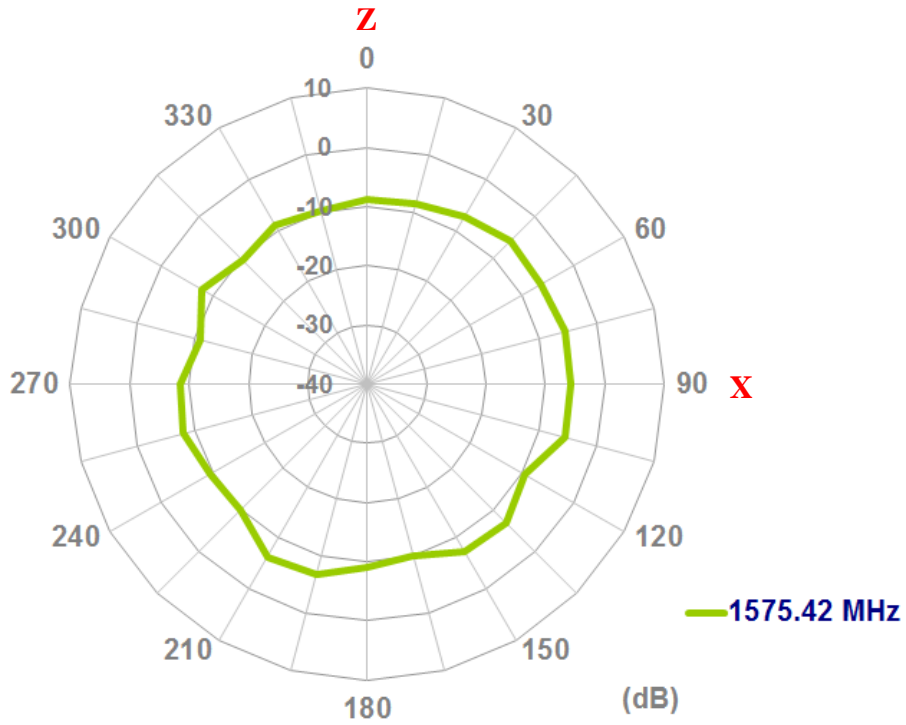

YZ-Plane

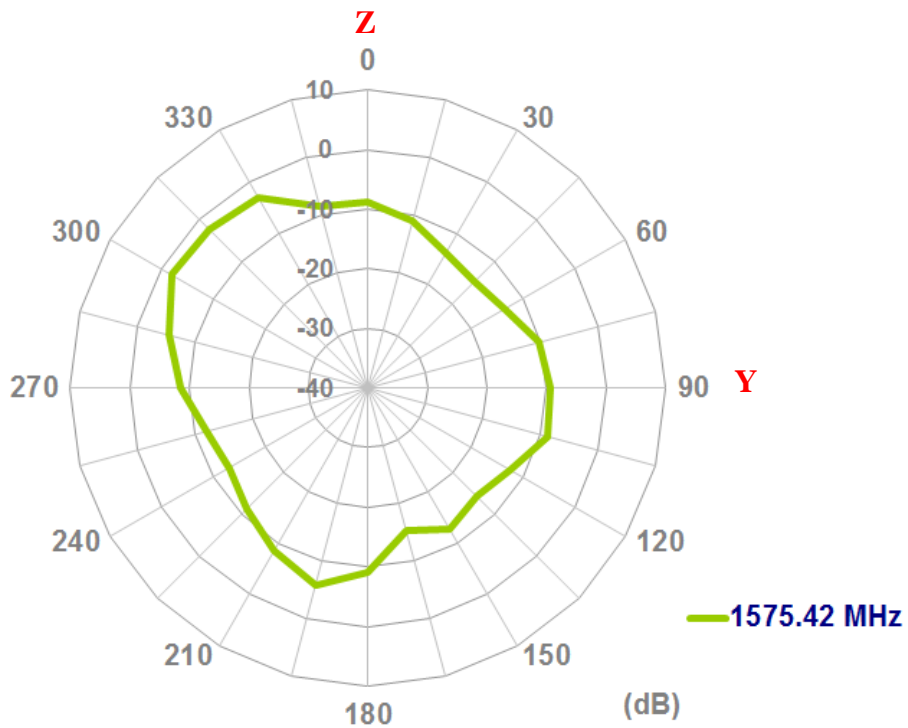
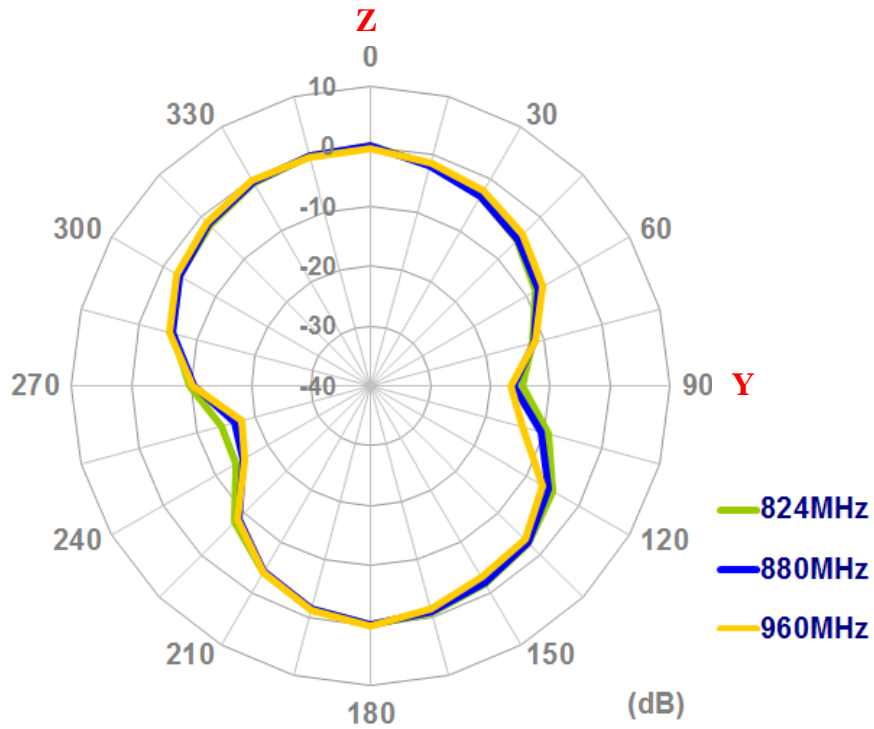

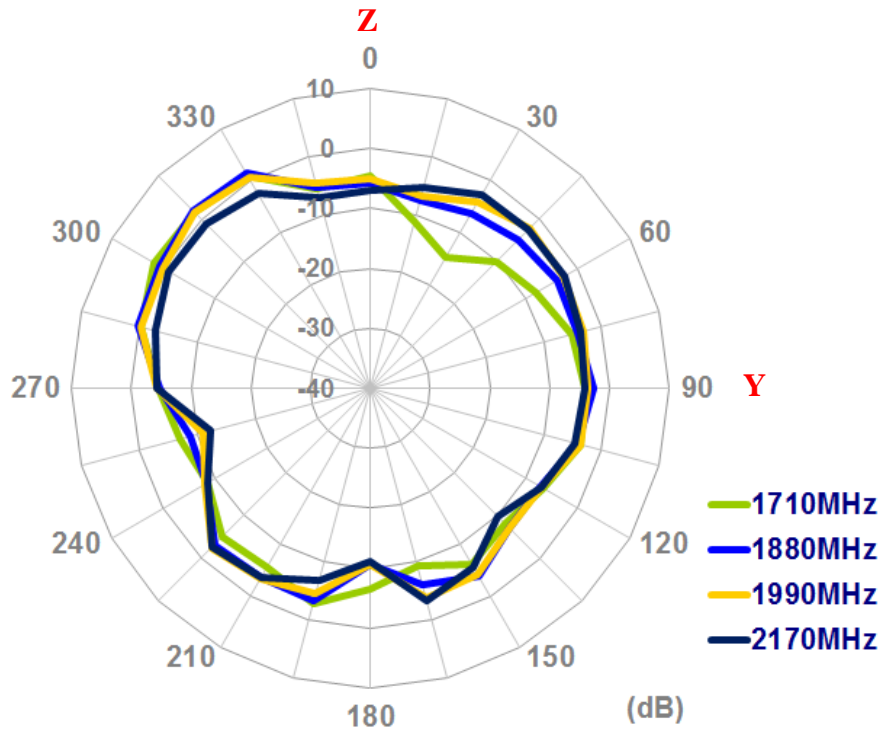

20cm*20cm Ground Plane Setup

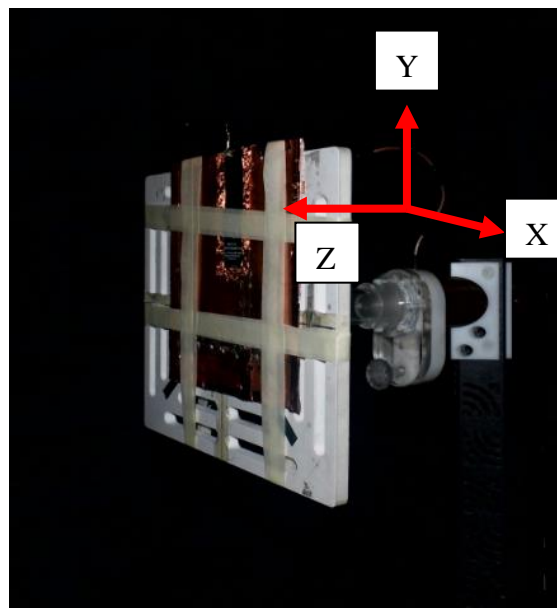

XY-Plane

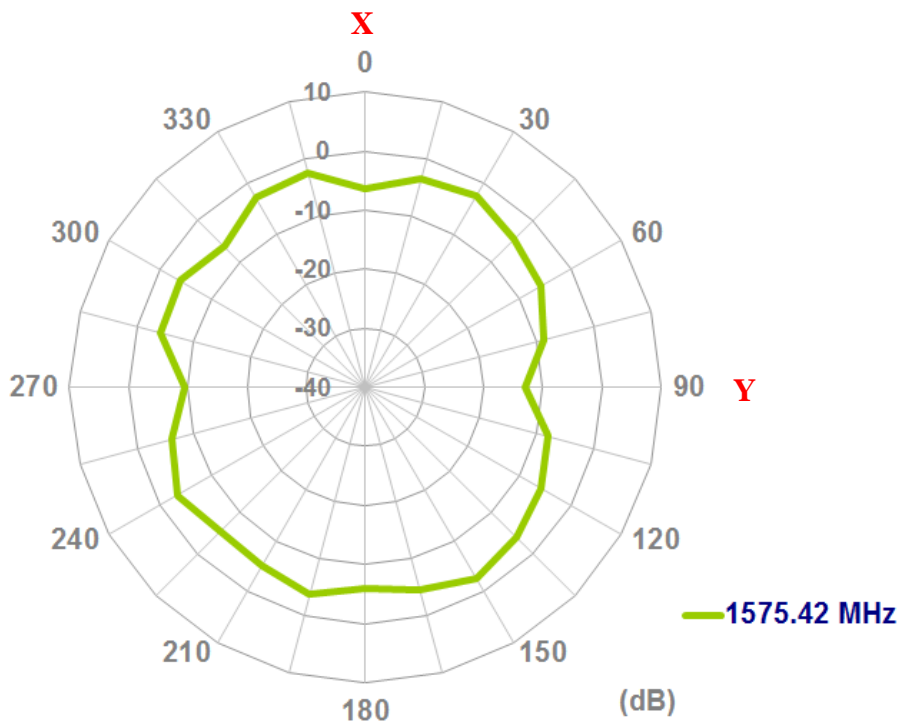
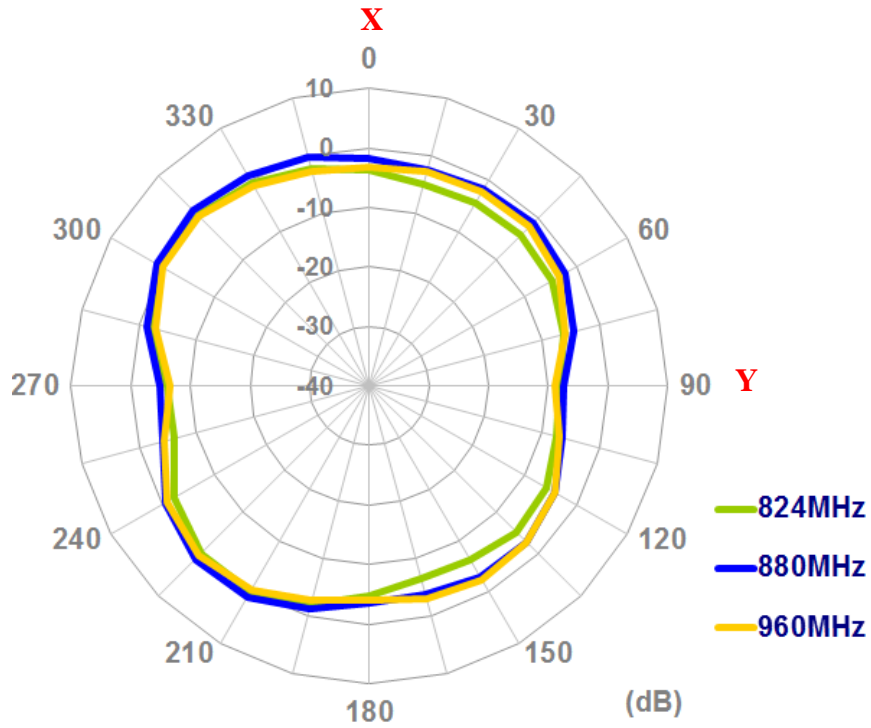

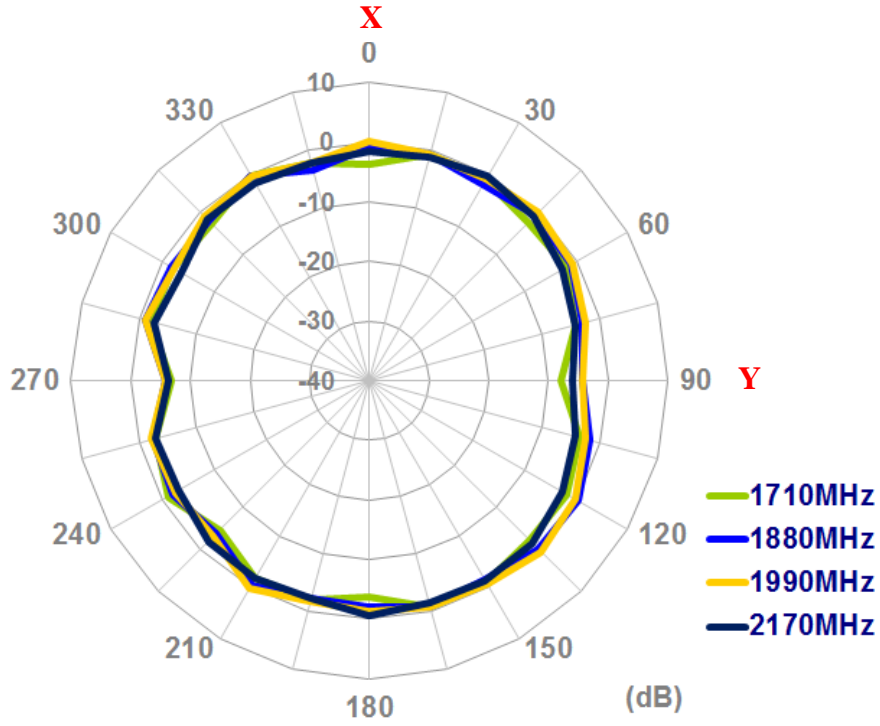

XZ-Plane

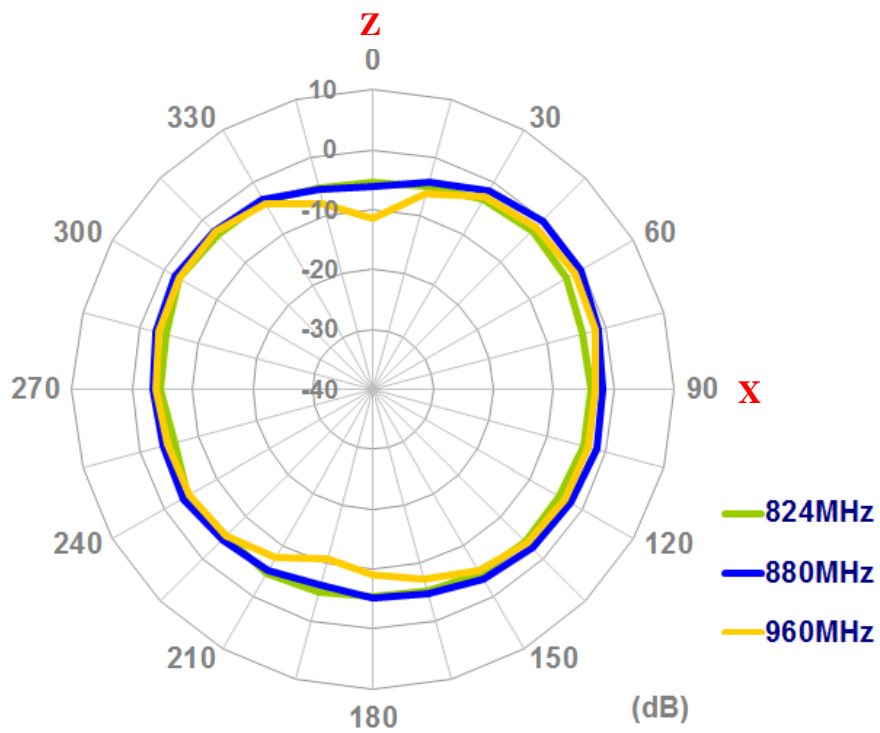

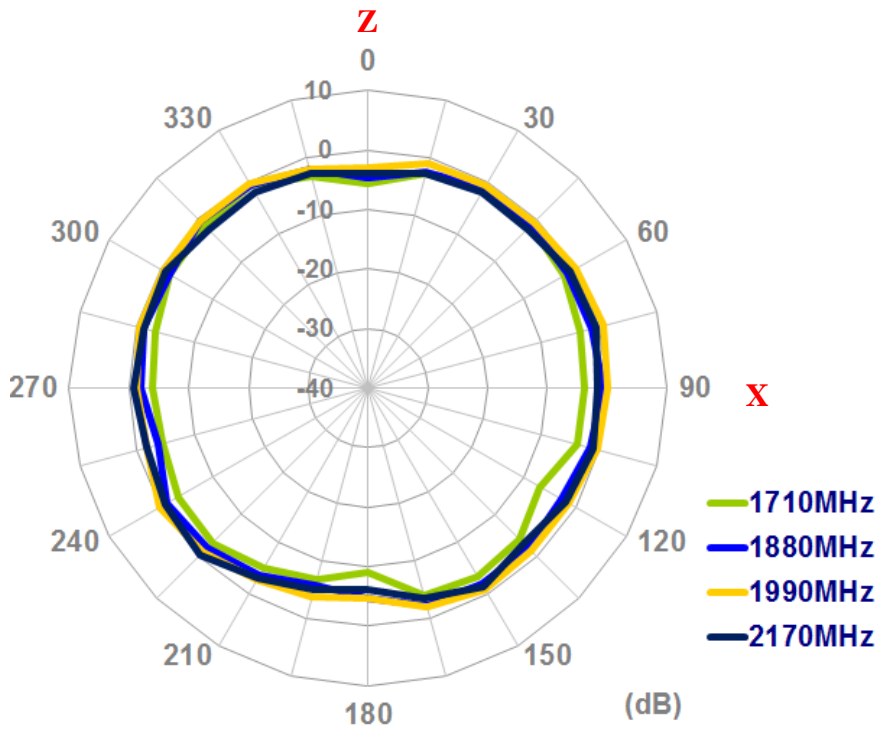
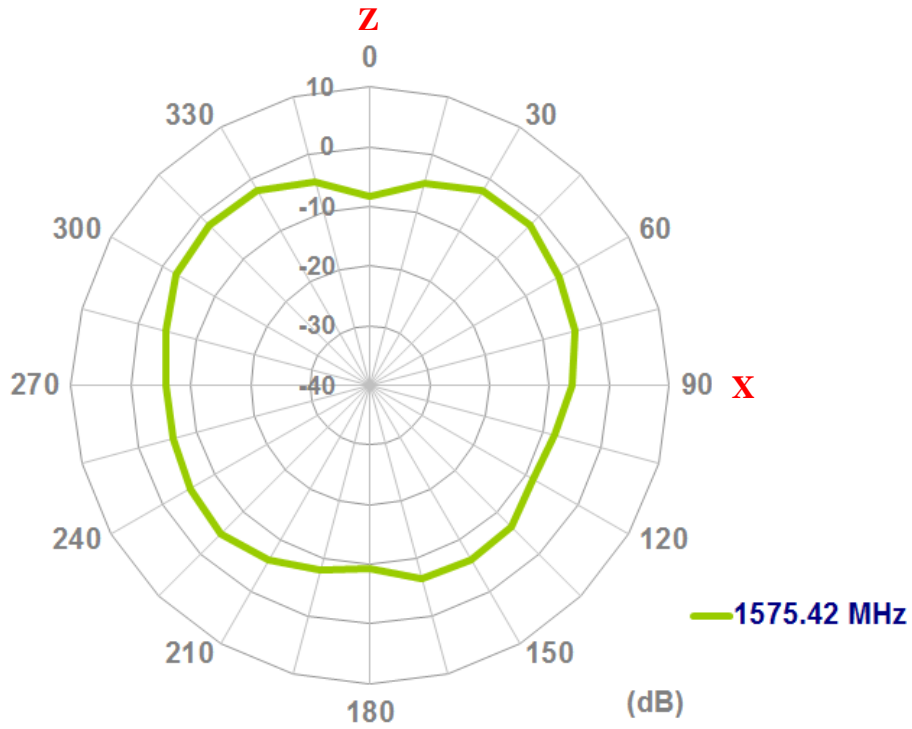

YZ-Plane

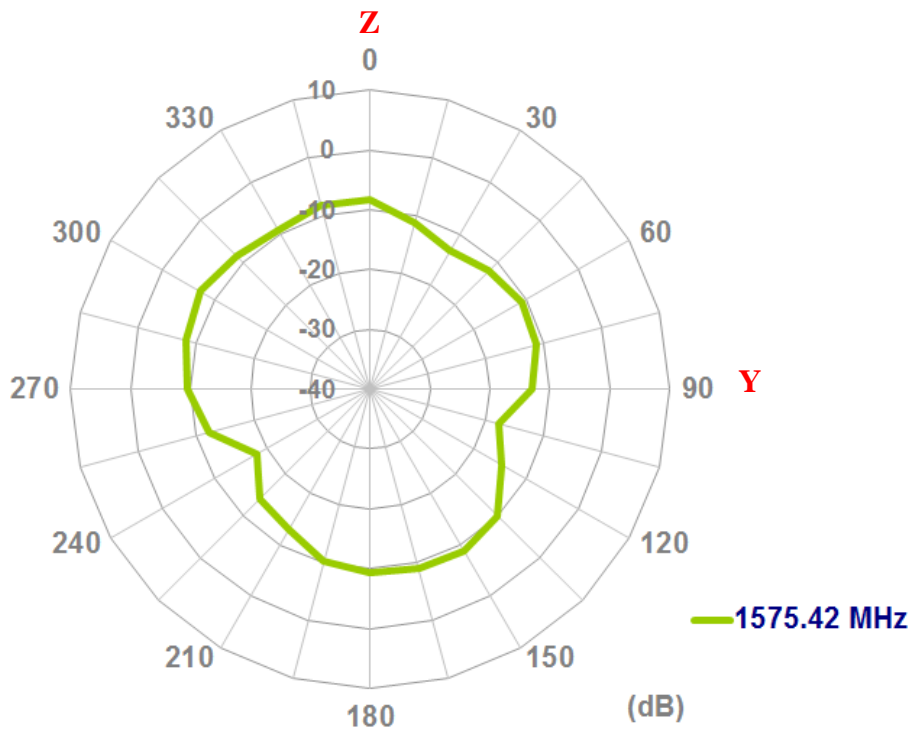
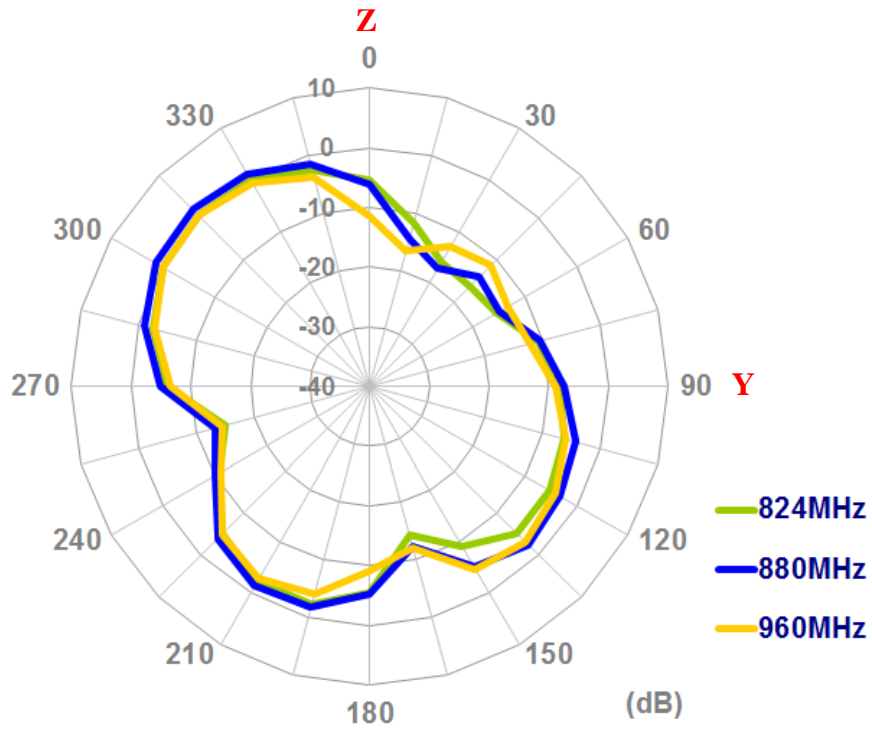

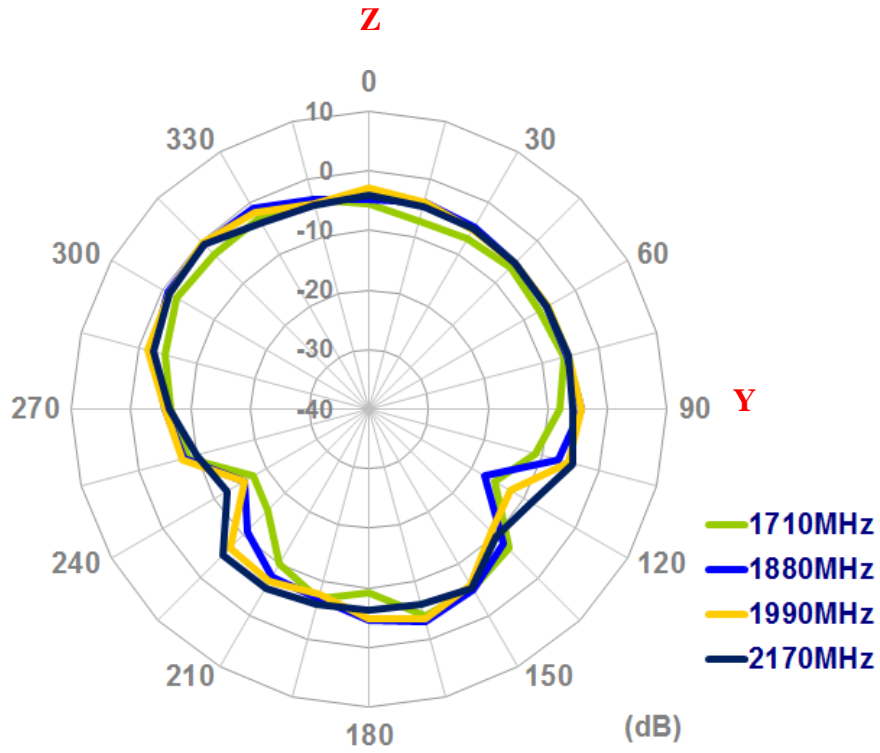

30cm*30cm Ground Plane

Setup

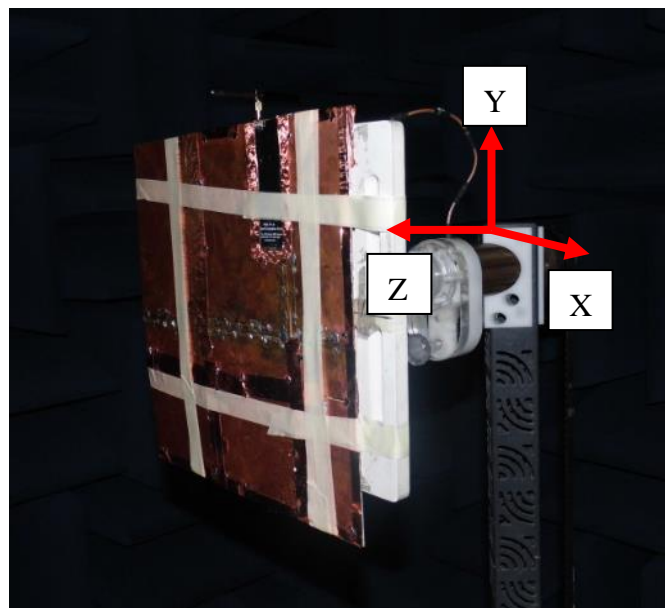

XY-Plane

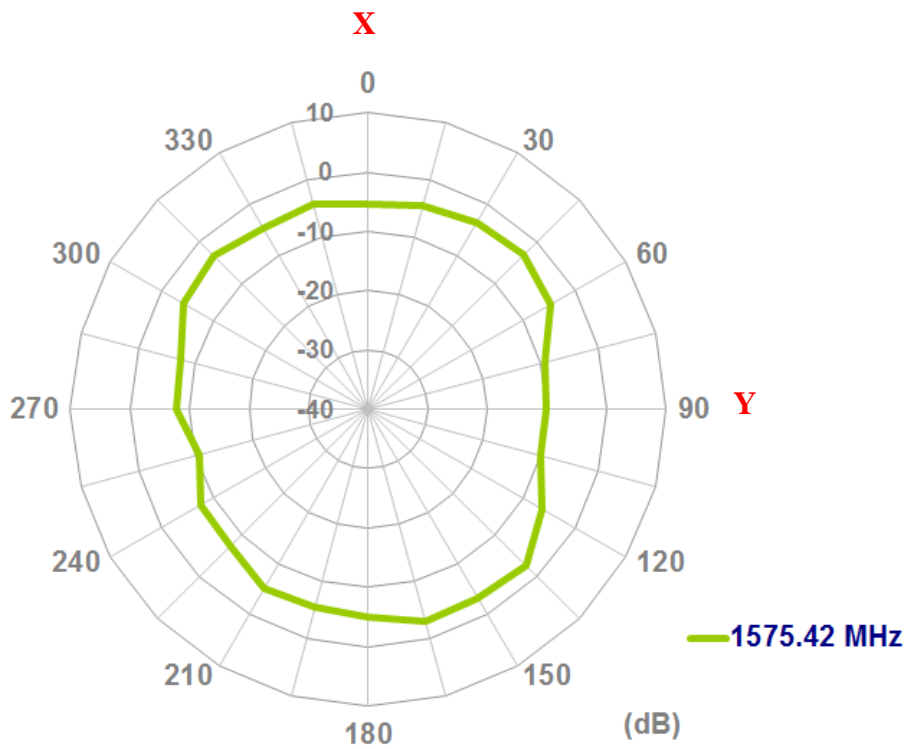
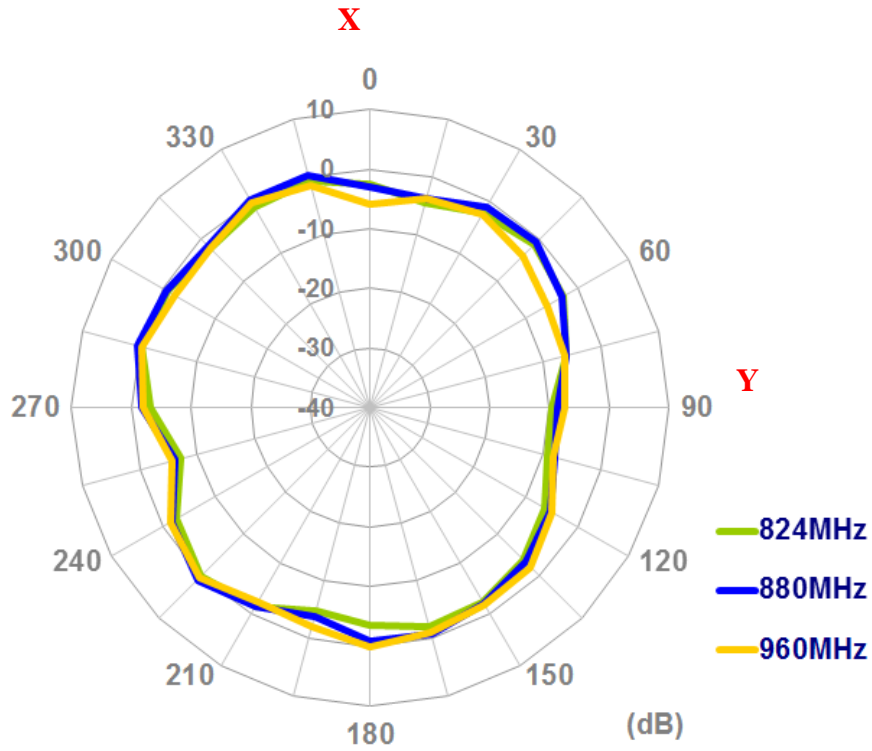

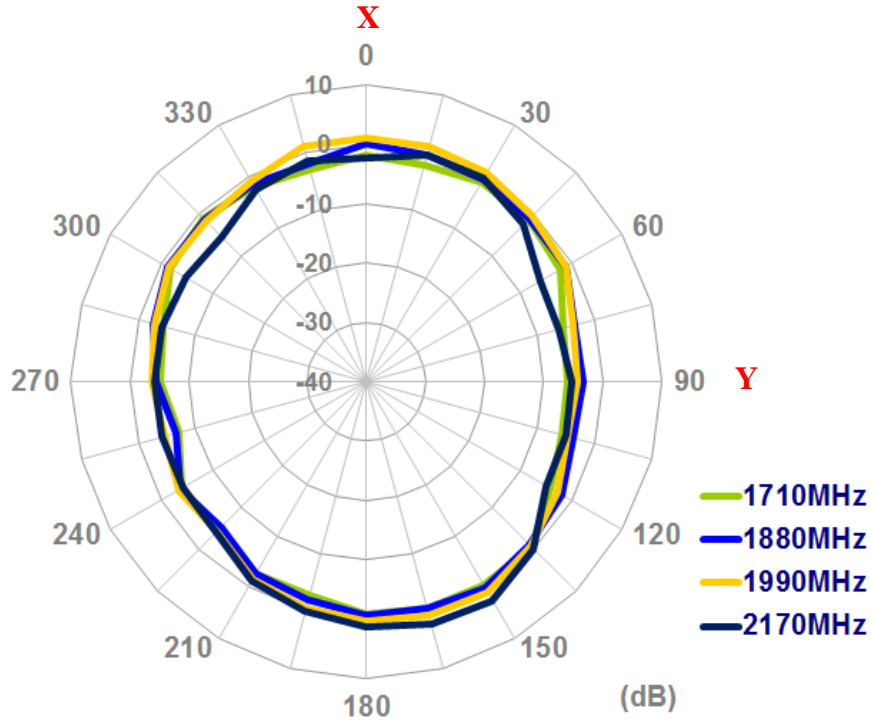

XZ-Plane

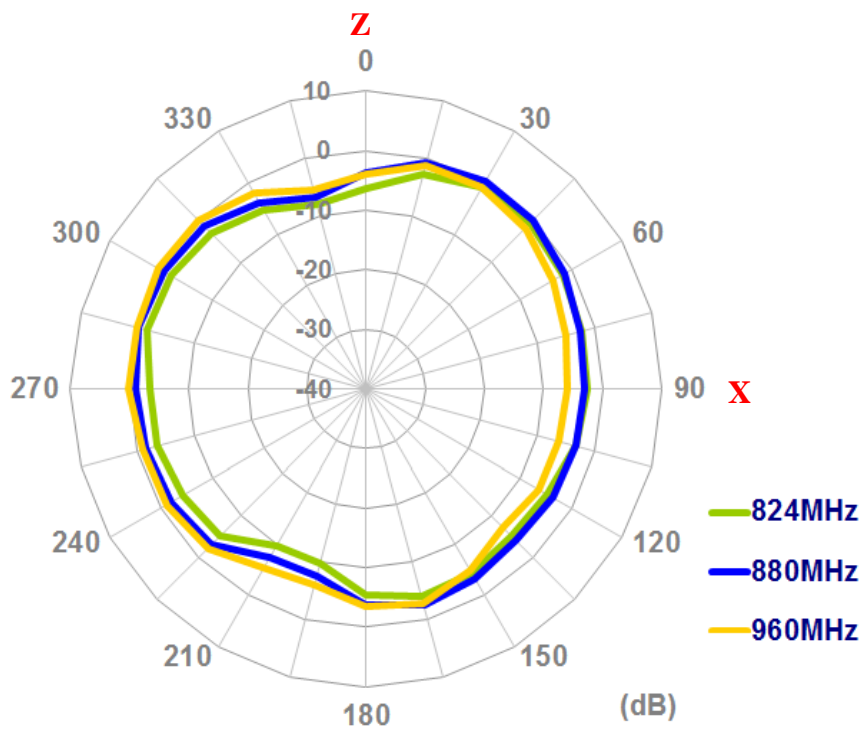

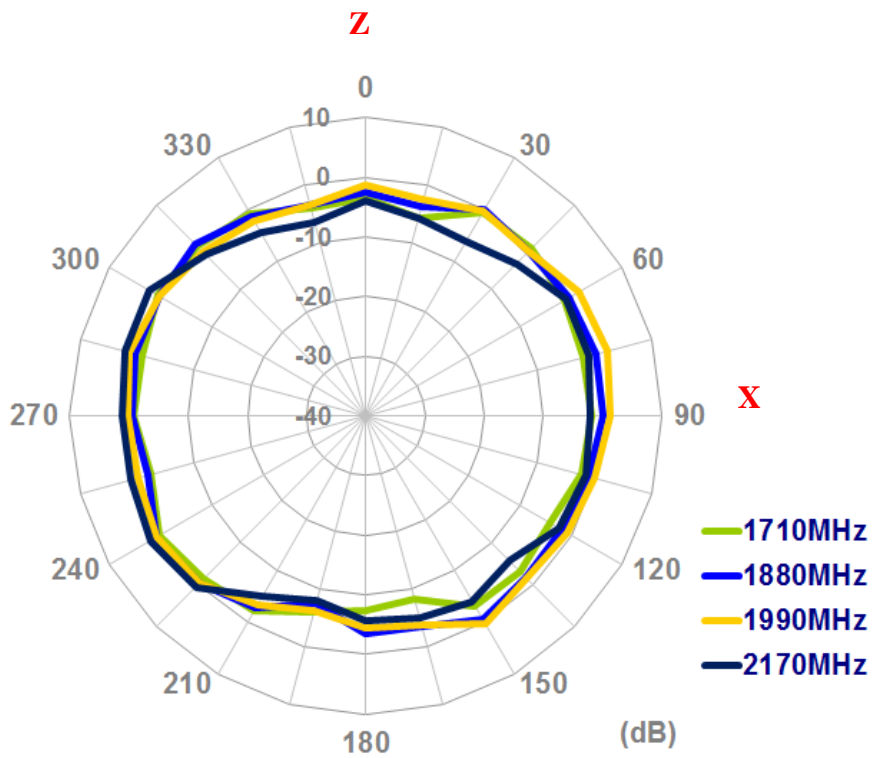
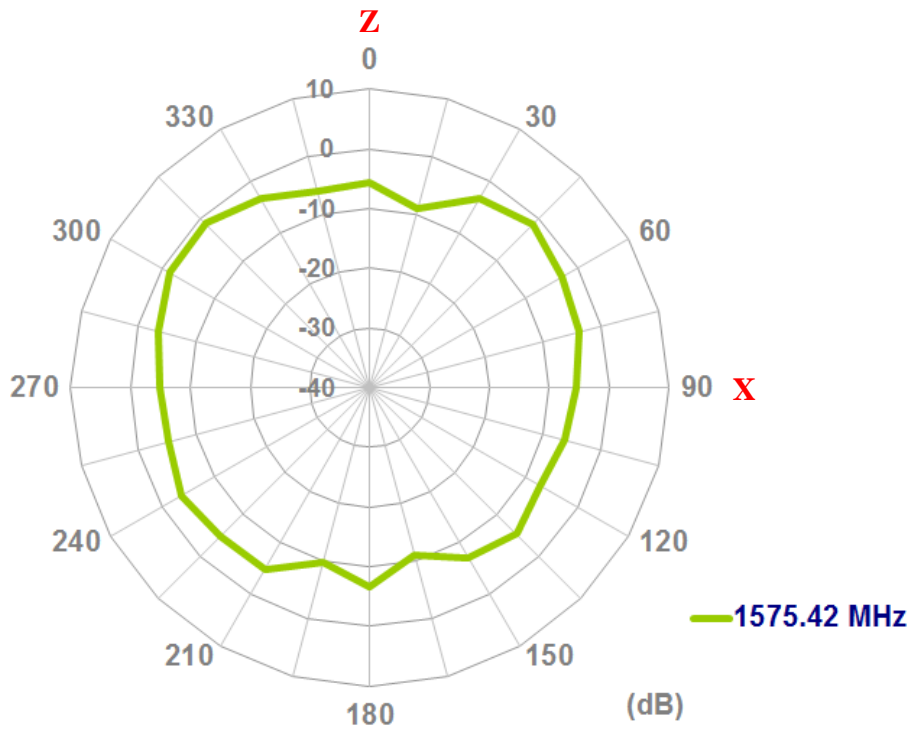

YZ-Plane

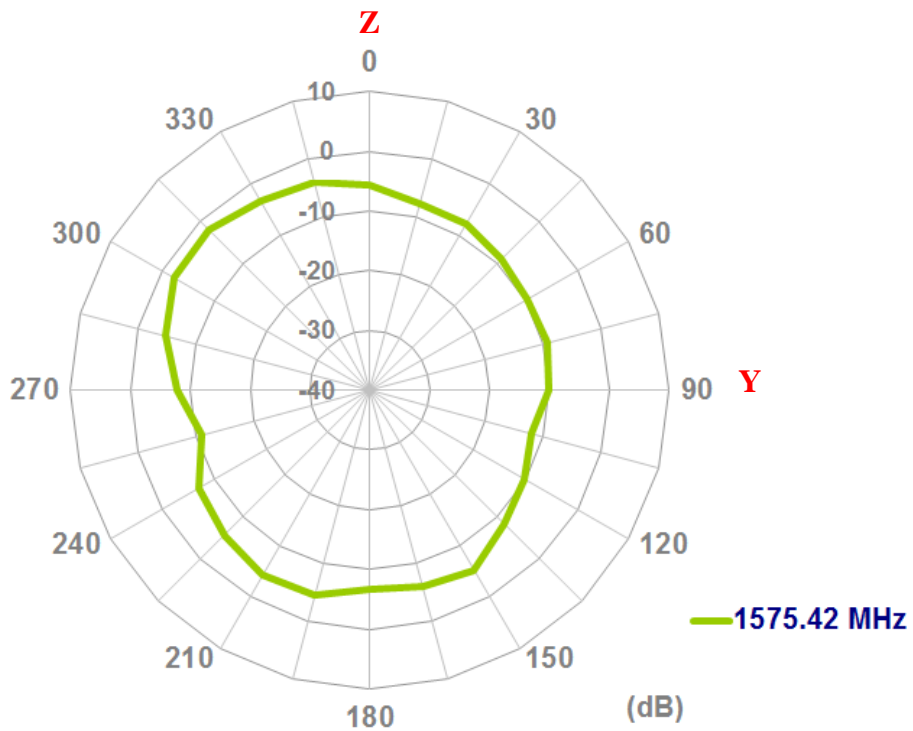
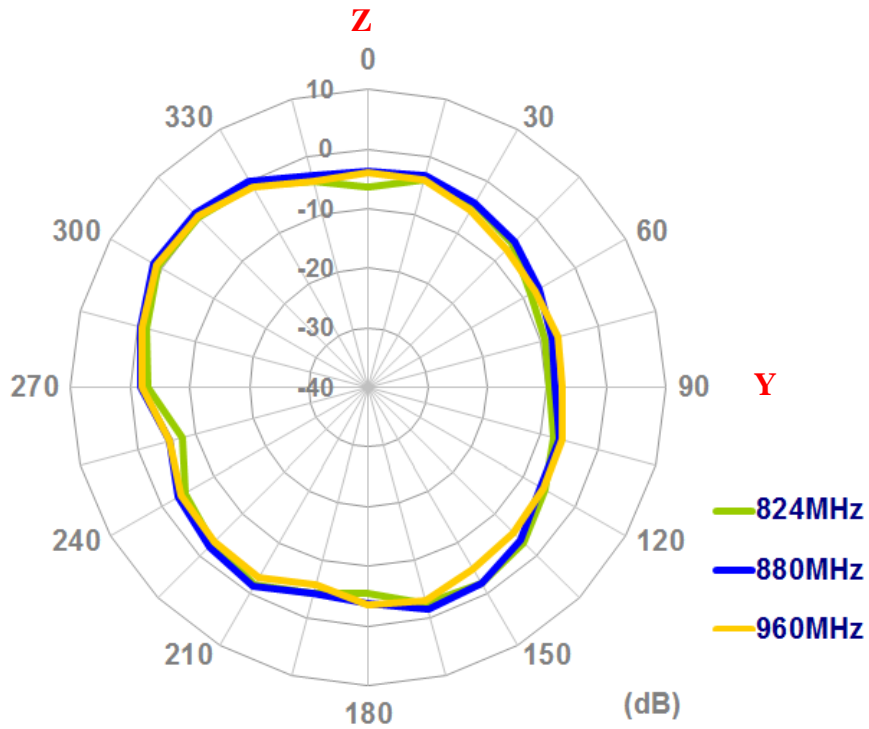

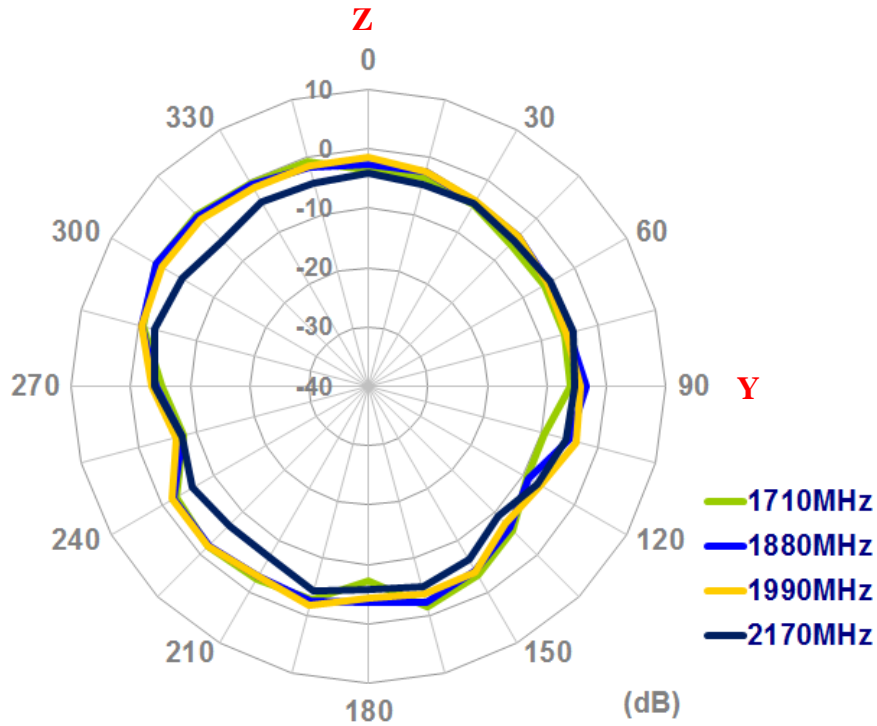

40cm*40cm Ground Plane

Setup

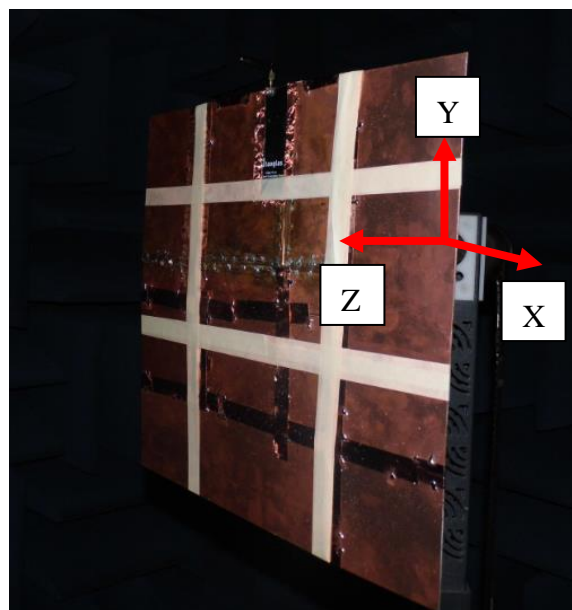

XY-Plane

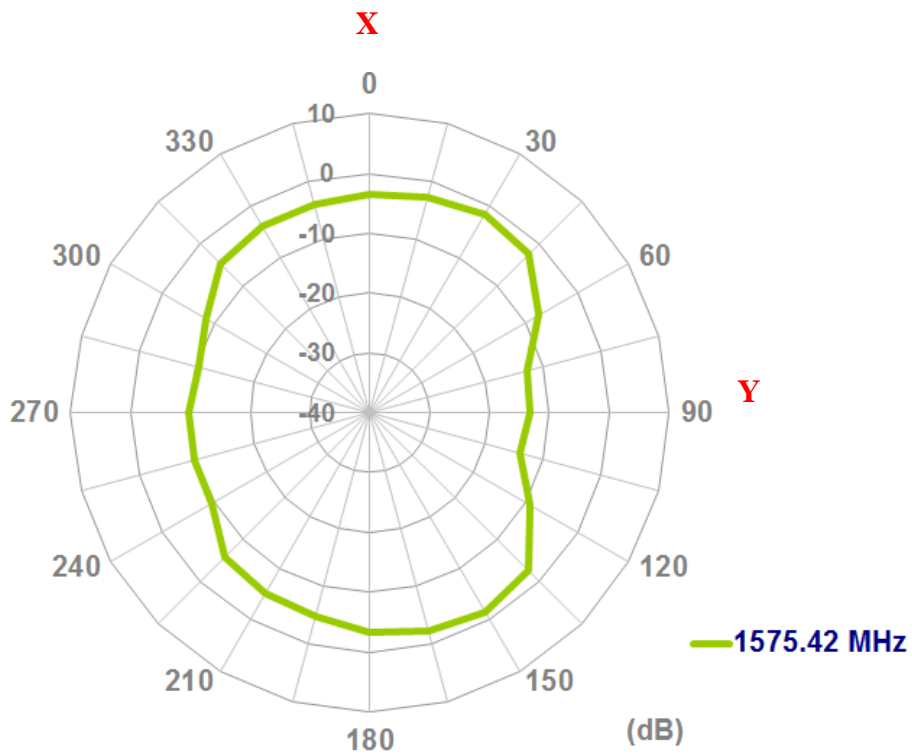
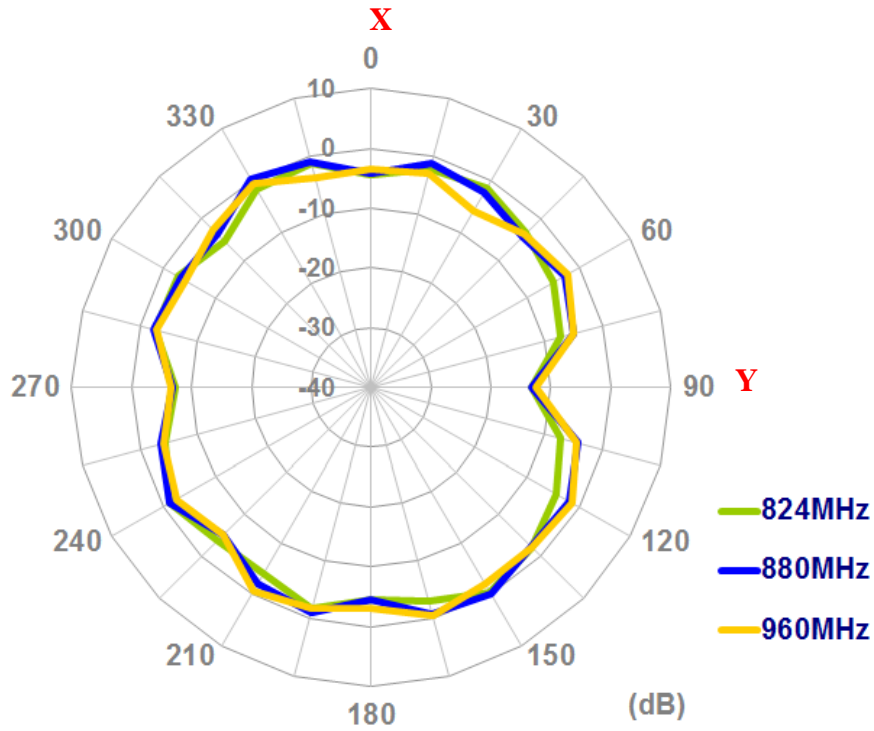

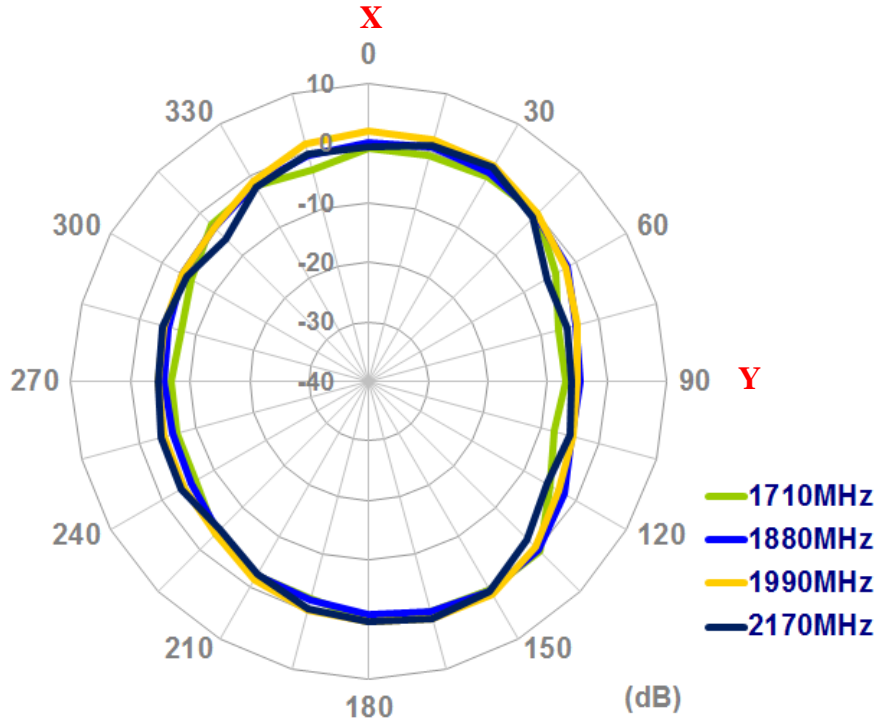

XZ-Plane

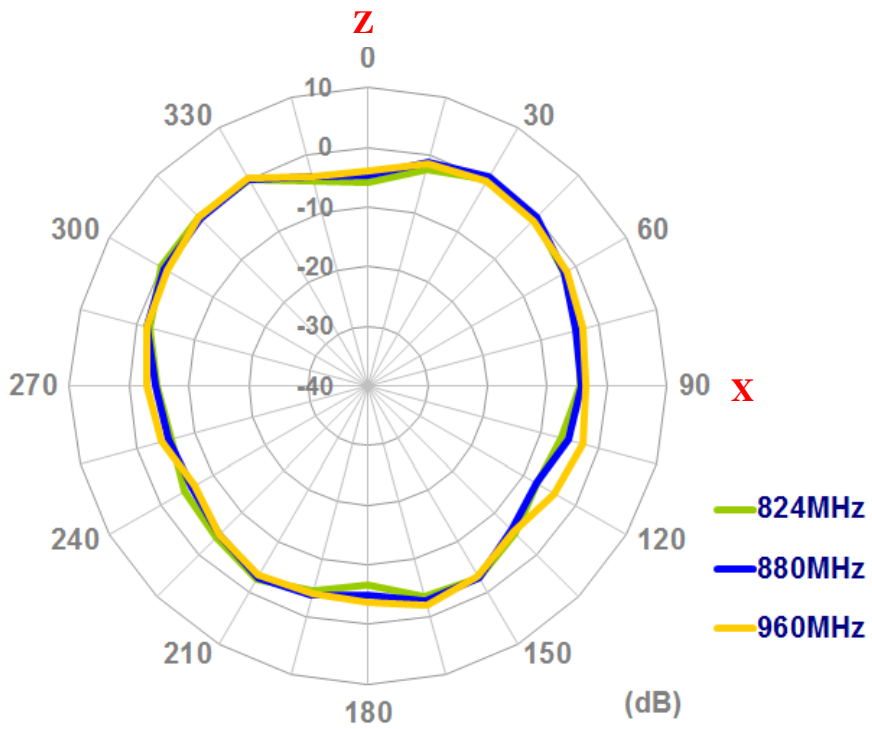

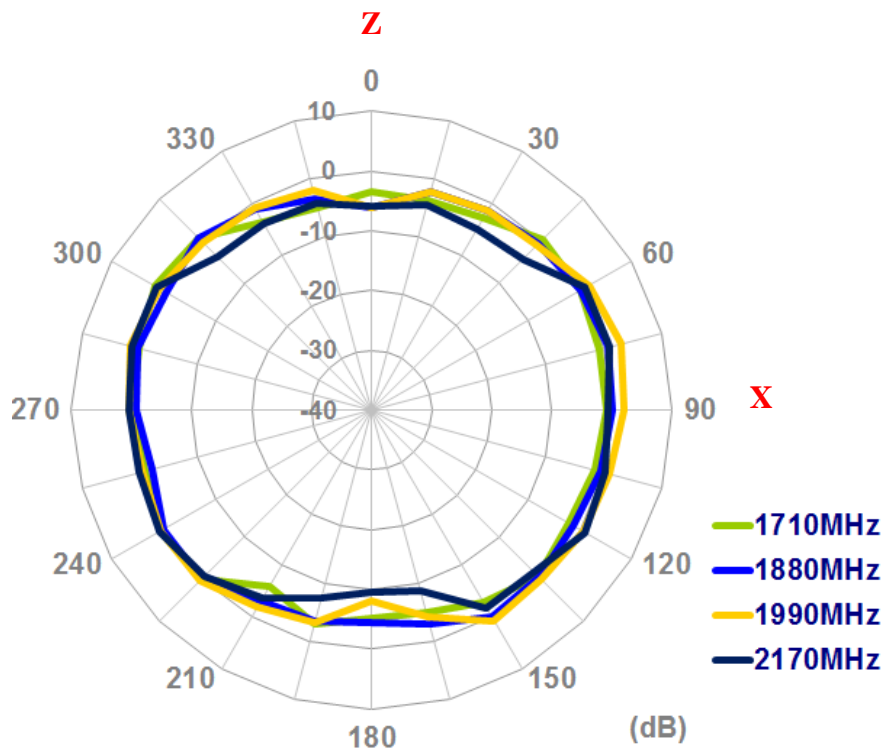
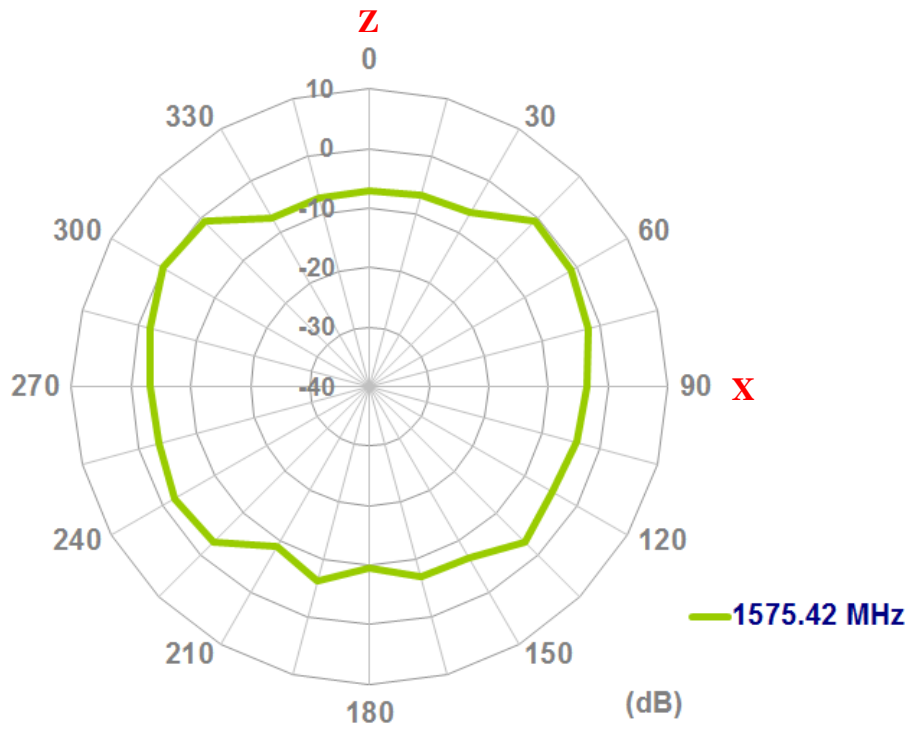

YZ-Plane

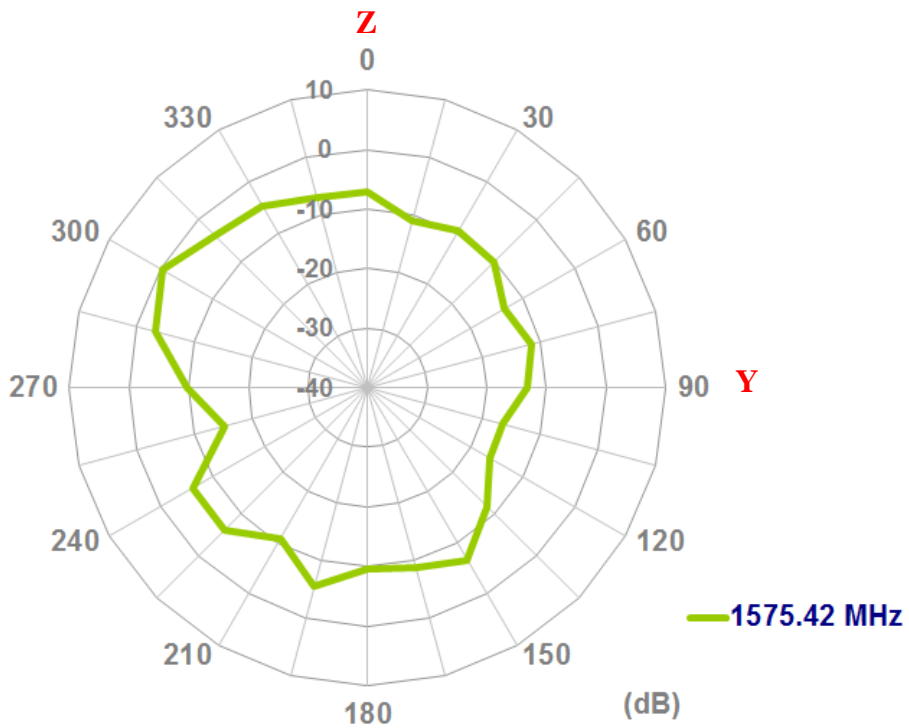
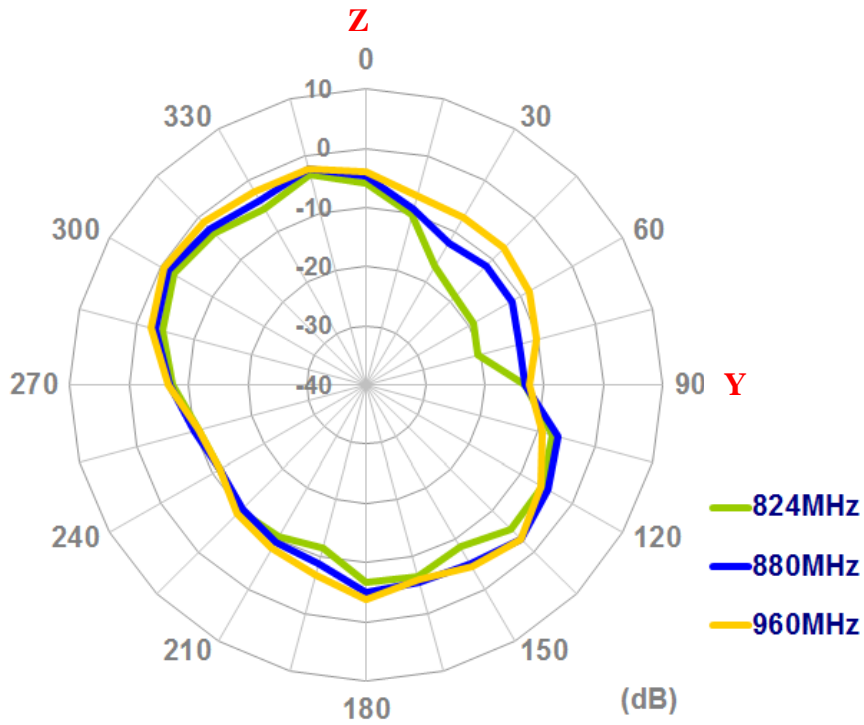

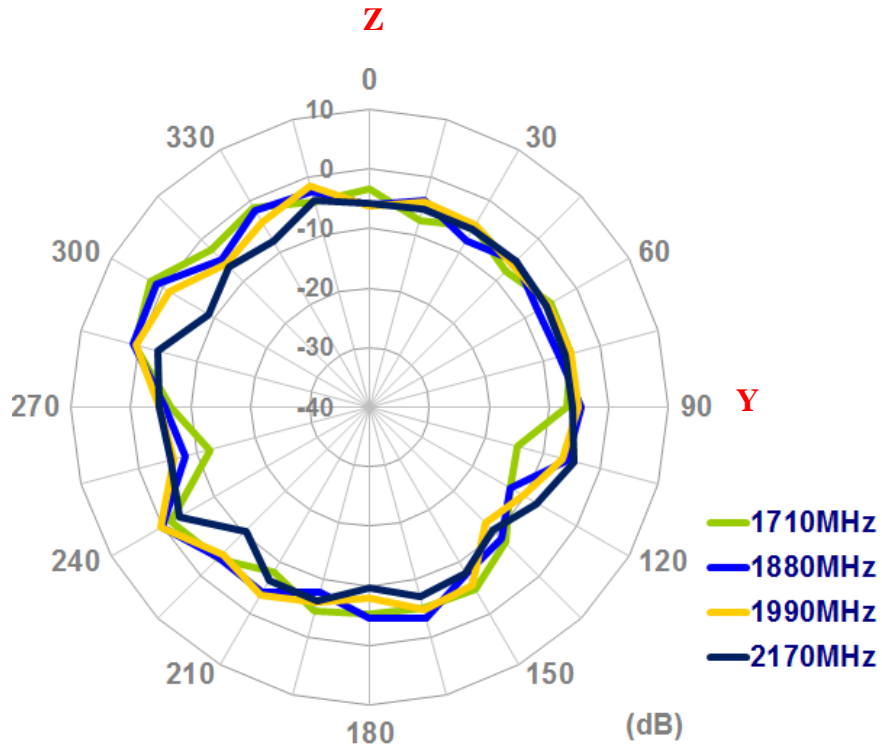

50cm*50cm Ground Plane Edge

Setup

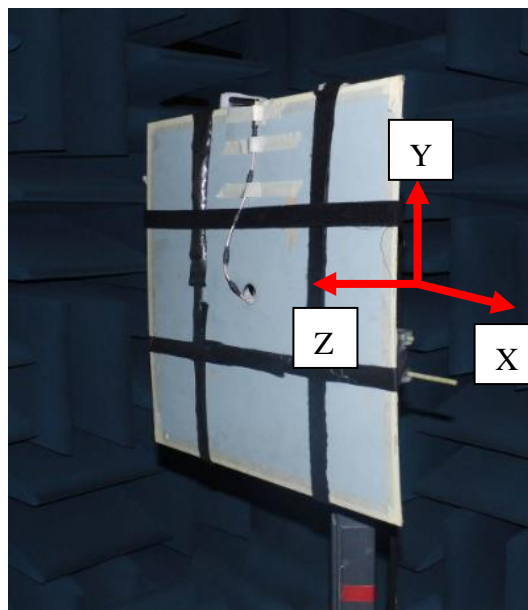

XY-Plane

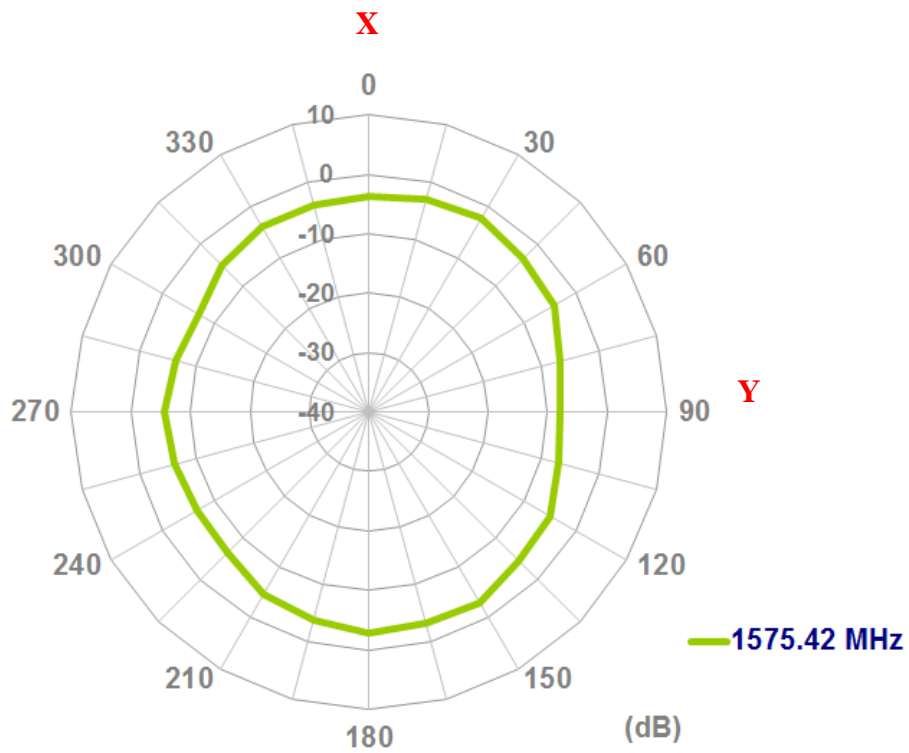
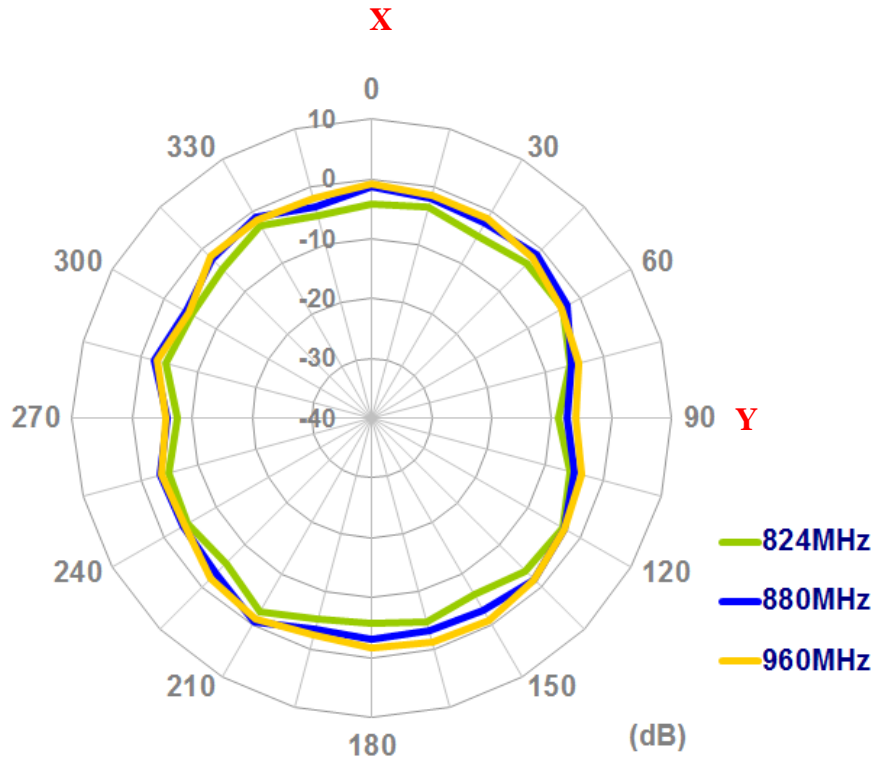

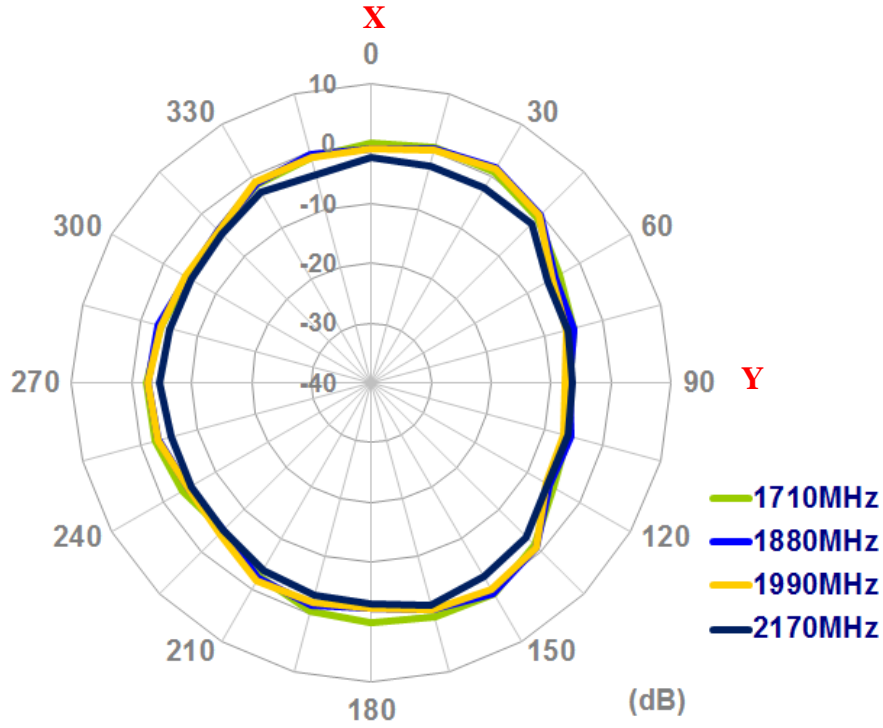

XZ-Plane

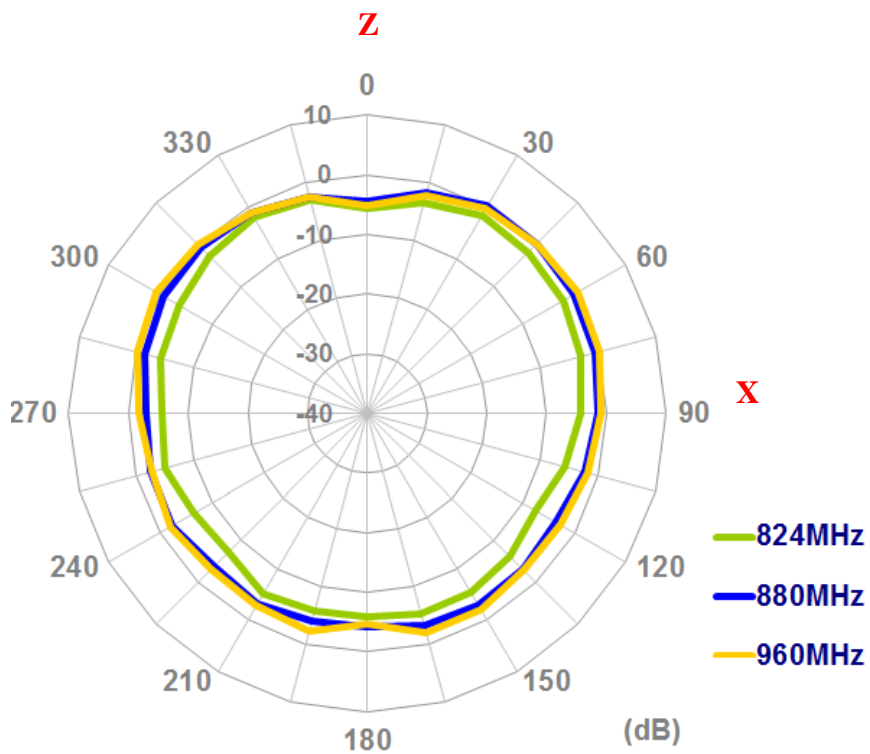

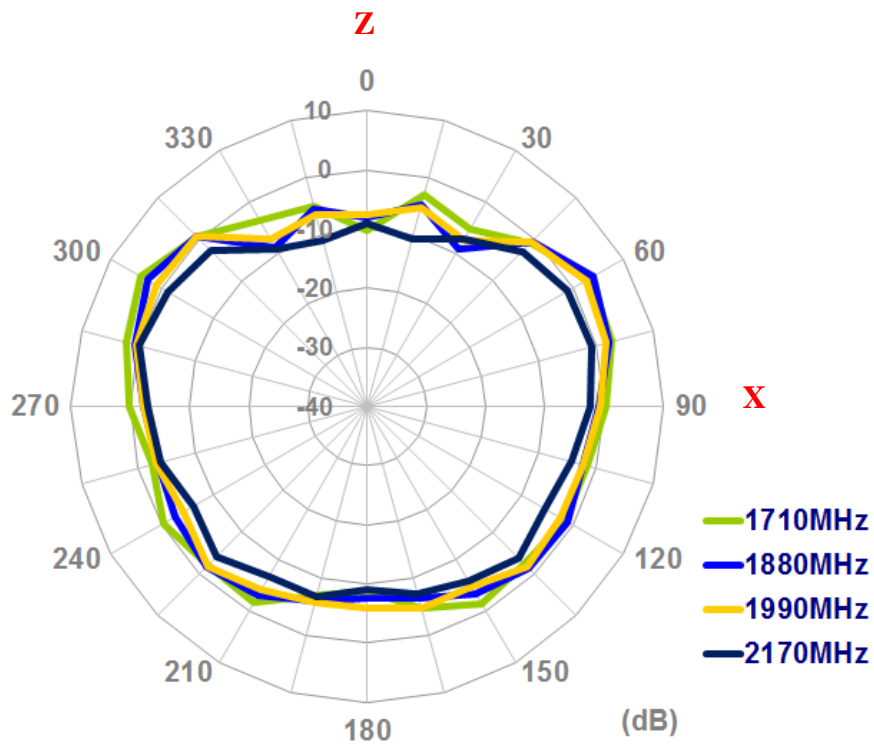
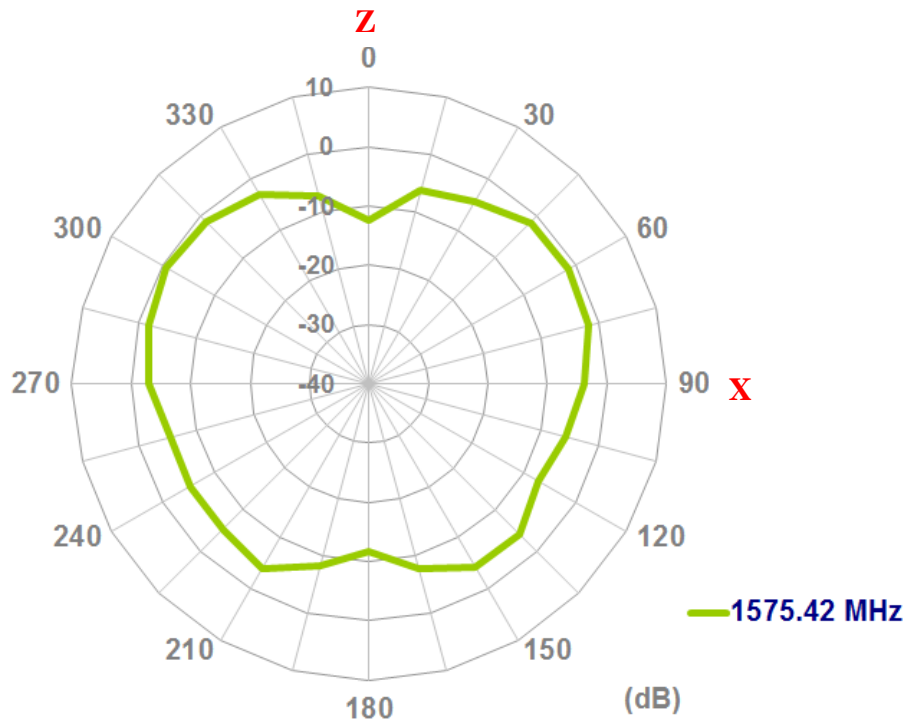

YZ-Plane

