

EN Zone für durchkontaktierte Löcher $\phi 0,6 \pm 0,05$
 compliant zone for thru hole $\phi 0,6 \pm 0,05$

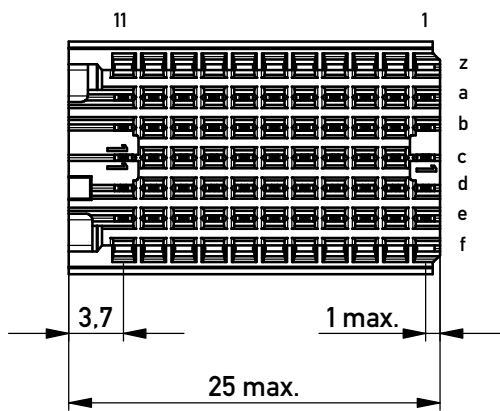

Bestückungsplan / contact layout

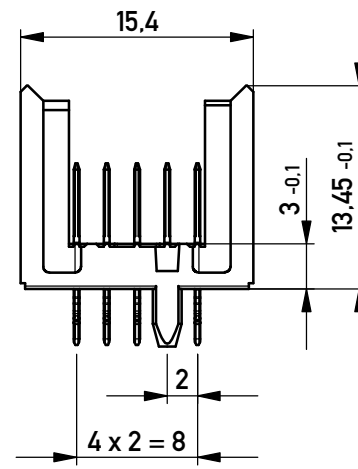
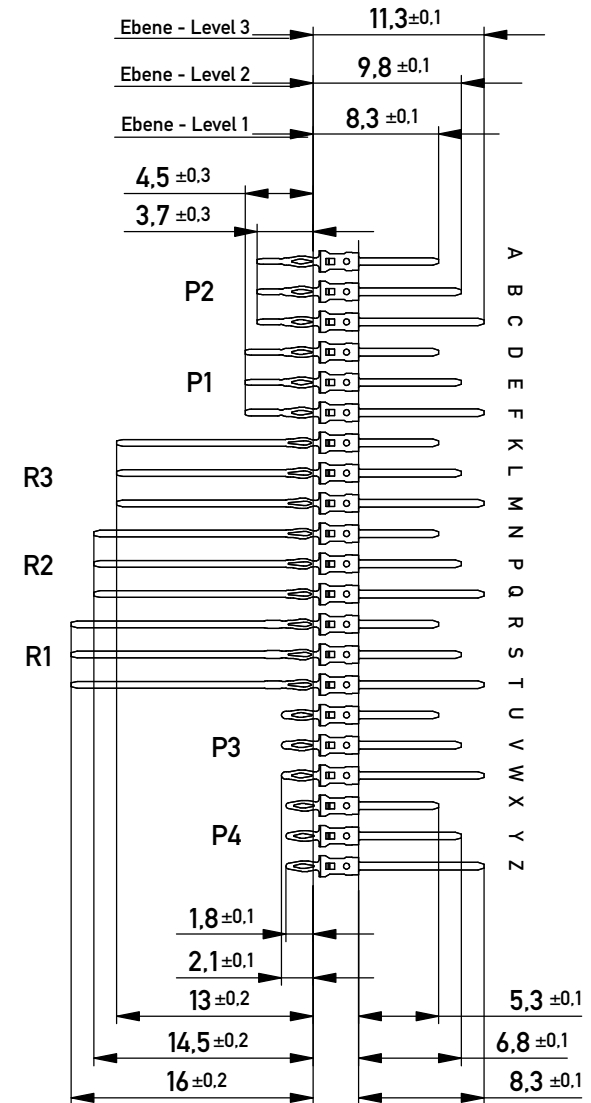
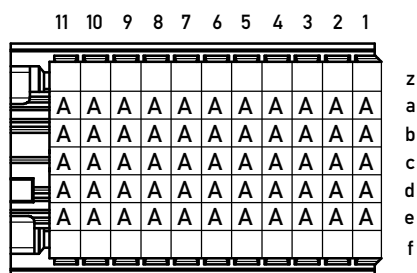

Lochbild für Leiterplatte (Bestückungsseite)

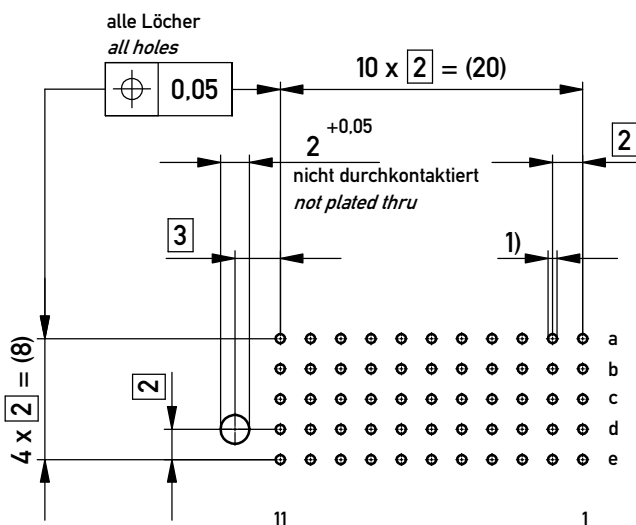

board hole pattern (component mounting side)



1) $\phi 0,6 \pm 0,05$ Durchmesser des metallisierten Loches
 $\phi 0,6 \pm 0,05$ Diameter of finished plated-through hole

Schichtaufbau im metallisierten Loch siehe Zeichnung 164062 Nr.1
 Metal plating of plated-through hole according to 164062 No.1

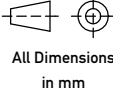
Fehlende Maße und Angaben nach IEC 61076-4-101
 Missing information and dimensions per IEC 61076-4-101

Information: P2 Level 1 siehe Bestückungsplan / see contact layout Anforderungsstufe 2 / class 2 All rights reserved. Only for Information. To ensure that this is the latest version of this drawing, please contact one of the ERNI companies before using.	Tolerances  All Dimensions in mm	Scale 2:1	Designation ERmet Messerleiste C ERmet Male Wide Type C
j Index	28.02.2018 Date	 www.ERNI.com	Class ERMC
			1 A3

Copyright by ERNI Production GmbH & Co. KG
 Proprietary notice pursuant to ISO 16016 to be observed.

Mouser Electronics

Authorized Distributor

Click to View Pricing, Inventory, Delivery & Lifecycle Information:

[ERNI Electronics:](#)

[044147](#)