





(b)

 CABLE STRAIN RELIEF (1x)	 LENS HEAD SCREW (4x)
 SHORT SCREW (2x)	 PRESS INSERT (1x)

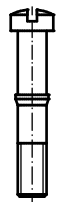

(b)

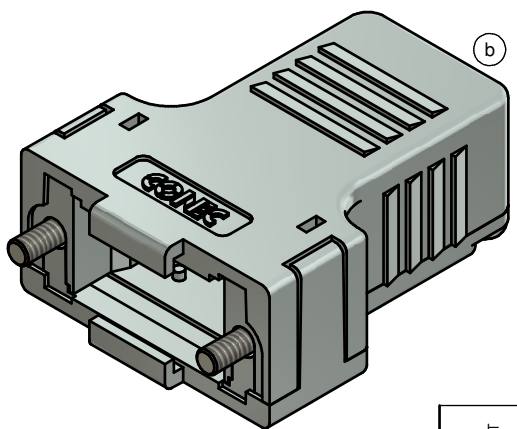
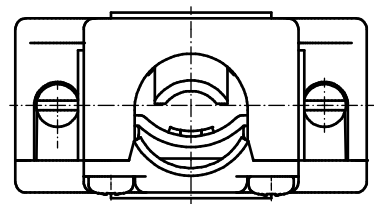

NOTES:

1. METALHOOD+COVER: ABS UL 94 V-0; METALLIZED
2. CABLE STRAIN RELIEF: STEEL; NICKEL PLATED
3. PRESS INSERT: ABS UL 94 V-0; METALLIZED
4. SHORT SCREWS: STEEL; NICKEL PLATED
5. LENS HEAD SCREWS: STEEL; NICKEL PLATED

TECHNICAL DATA:

- TEMPERATURE RANGE: -33 °C to + 90 °C

Directive 2011/65/EU RoHS compliant

THIS DRAWING MAY NOT BE COPIED OR REPRODUCED IN ANY WAY, AND MAY NOT BE PASSED ON TO A THIRD PARTY WITHOUT WRITTEN PERMISSION. OWNERSHIP AND COPYRIGHT OF CONEC GmbH DO NOT ALTER CAD DRAWING BY HAND	tolerance		 dim. in mm		scale: 2:1		
					material: SEE NOTES		
			date		name		
			drawn 03.09.14		Unkrüer		
			appd. 04.09.14		Lehmenkühler		
			norm		title:		
		d-old		16K2A171A			
3 x b		Ä 5304		03.09.2014		Unkrüer	
a		Original					
rev.		description		date		name	
							
						dwg no: (b) 16K1A3513	
						part no: 165X13469X	
						DIN-A3 sh: 1	